







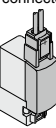

Series 10-SYJ300/500/700

Rubber Seal
3 Port Solenoid Valve

Variations

	Series	Port size	Sonic conductance C [dm ³ /(s·bar)]	Actuation type	Voltage	Electrical entry	Option	Manual override
							Light/Surge voltage suppressor	
Body ported	10-SYJ300  P.604	M3 x 0.5	[Effective area 0.9 mm ² { 2→3 } {(A→R)}	● N.C. ● N.O.	For DC ■ 24 VDC 12 VDC 6 VDC 5 VDC 3 VDC	Grommet  L plug connector  M plug connector 	For DC ■ With surge voltage suppressor ■ With light/surge voltage suppressor	■ Non-locking push type ■ Push-turn locking slotted type ■ Push-turn locking lever type
	10-SYJ500  P.615	M5 x 0.8	0.66 { 2→3 } {(A→R)}					
	10-SYJ700  P.627	1/8	2.5 { 2→3 } {(A→R)}					
Base mounted	10-SYJ300  P.604	M5 x 0.8	0.36 { 2→3 } {(A→R)}		For AC ■ 100 VAC $\frac{50}{60}$ Hz 110 VAC $\frac{50}{60}$ Hz 200 VAC $\frac{50}{60}$ Hz 220 VAC $\frac{50}{60}$ Hz	DIN terminal  (SYJ500, 700 only)	For AC (Note) ■ With light/surge voltage suppressor	
	10-SYJ500  P.615	1/8	1.2 { 2→3 } {(A→R)}					
	10-SYJ700  P.627	1/8, 1/4	2.7 { 2→3 } {(A→R)}					

Note) All AC voltage models have built-in surge voltage suppressor.

Directional Control Valves

Air Cylinders

Rotary Actuators

Air Grippers

Air Preparation Equipment

Modular F. R.

Pressure Control Equipment

Fittings & Tubing

Flow Control Equipment

Pressure Switches/Pressure Sensors

Manifold Variations

	Valve series	A port location	P, R ports size	A port size							
				M3	M5	1/8	With One-touch fitting				
							Applicable tubing O.D.				
				ø4	ø6	ø8	N3	N7	N9		
Body ported	10-SYJ300 P.609	Top	M5 x 0.8	Note)	—	—	—	—	—	—	
	10-SYJ500 P.620	Top	1/8	—	●	—	—	—	—	—	
	10-SYJ700 P.632	Top	1/8	—	—	Note)	—	—	—	—	—
1/4			—	—	●	—	—	—	—	—	
Base mounted	10-SYJ300 P.609	Side	M5 x 0.8	Note)	—	—	—	—	—	—	
			1/8	—	●	—	●	—	●	—	—
	10-SYJ500 P.620	Bottom	1/8	—	●	●	—	—	—	—	—
		Side		—	●	●	●	●	—	●	●
	10-SYJ700 P.632	Bottom	1/8	—	—	Note)	—	—	—	—	—
			1/4	—	—	●	—	—	—	—	—
	Side	1/4	—	—	●	—	●	●	—	●	

Note) Only for internal pilot

Base mounted

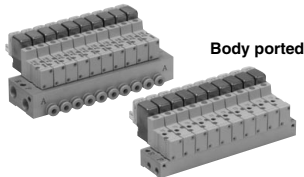

Series 10-SYJ300

Base mounted

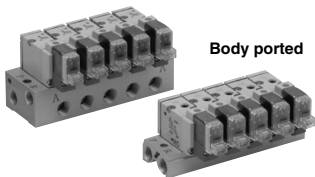

Series 10-SYJ500

Base mounted

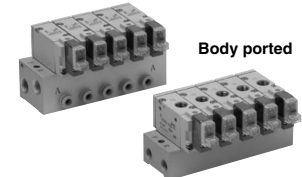

Series 10-SYJ700

Series 10-SYJ300

Rubber Seal
3 Port Pilot Solenoid Valve



Specifications

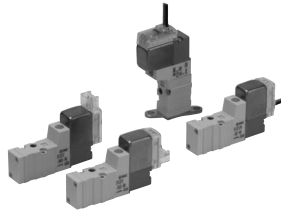

Body ported

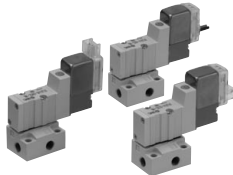

Base mounted

Symbol

Internal pilot

10-SYJ31 $\frac{1}{2}$ M

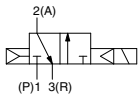

10-SYJ32 $\frac{1}{2}$ M

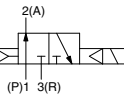

Made to Order
(For details, refer to page 640.)

Fluid		Air
Operating pressure range (MPa)	Internal pilot	0.15 to 0.7
Ambient and fluid temperature (°C)		-10 to 50 (No freezing.)
Response time ms (at 0.5 MPa) ^{Note 1)}		15 or less
Max. operating frequency (Hz)		10
Manual override (Manual operation)		Non-locking push type, push-turn locking slotted type, push-turn locking lever type
Pilot exhaust method		Main/Pilot valve common exhaust
Lubrication		Not required
Mounting orientation		Unrestricted
Impact/Vibration resistance (m/s ²) ^{Note 2)}		150/30
Enclosure		Dust proof (* M8 connector conforms to IP65.)

* Based on IEC60529

Note 1) Based on dynamic performance test, JIS B 8374-1981. (Coil temperature: 20°C, at rated voltage, without surge voltage suppressor.)

Note 2) Impact resistance: No malfunction occurred when it was tested in the axial direction and at right angles to the main valve and armature in both energized and de-energized states once for each condition. (Default settings)

Vibration resistance: No malfunction occurred in a one-sweep test between 45 and 2000 Hz. Test was performed in both energized and de-energized states in the axial direction and at right angles to the main valve and armature. (Default settings)

Solenoid Specifications

Electrical entry		Grommet (G), (H), L plug connector (L), M plug connector (M), M8 connector (W)	
Coil rated voltage (V)	DC	24, 12, 6, 5, 3	
	AC ^{50/60} Hz	100, 110, 200, 220	
Allowable voltage fluctuation		±10% of rated voltage *	
Power consumption (W)	DC	Standard	0.35 (With light: 0.4)
		With power saving circuit	0.1 (With light only) * [Starting 0.4, Holding 0.1]
Apparent power (VA) *	AC	100 V	0.78 (With light: 0.81)
		110 V	0.86 (With light: 0.89)
		[115 V]	[0.94 (With light: 0.97)]
		200 V	1.18 (With light: 1.22)
		220 V [230 V]	1.30 (With light: 1.34) [1.42 (With light: 1.46)]
Surge voltage suppressor		Diode (Varistor when non-polar types)	
Indicator light		LED	

* Common between 110 VAC and 115 VAC, and between 220 VAC and 230 VAC.

* For 115 VAC and 230 VAC, the allowable voltage is -15% to +5% of rated voltage.

* For details, refer to page 643.

Flow Rate Characteristics/Weight

Valve model	Actuation type	Port size	Flow rate characteristics						Effective area (mm ²)	Weight (g) ^{Note)}		
			1→2 (P→A)			2→3 (A→R)				Grommet	L/M plug connector	M8 connector
			C [dm ³ /(s bar)]	b	Cv	C [dm ³ /(s bar)]	b	Cv				
Body ported	10-SYJ312M	N.C.	M3 x 0.5	—	—	—	—	—	0.9	32	33	37
	10-SYJ322M	N.O.		—	—	—	—	—				
Base mounted (with sub-plate)	10-SYJ314M	N.C.	M5 x 0.8	0.41	0.18	0.086	0.35	0.33	—	53 (32)	54 (33)	58 (37)
	10-SYJ324M	N.O.		0.36	0.31	0.089	0.36	0.31				

Note) Value for DC. Add 1 g for AC. (): Without sub-plate.

Directional Control Valves

Air Cylinders

Rotary Actuators

Air Grippers

Air Preparation Equipment

Modular F. R.

Pressure Control Equipment

Fittings & Tubing

Flow Control Equipment

Pressure Switches/Pressure Sensors



Note) CE-compliant:
For DC only. [Option]

How to Order

Light/Surge voltage suppressor

Nil	Without light/surge voltage suppressor
S	With surge voltage suppressor
Z	With light/surge voltage suppressor
R	With surge voltage suppressor (Non-polar type)
U	With light/surge voltage suppressor (Non-polar type)

- * For AC voltage valves there is no "S" option. It is already built into the rectifier circuit.
- * For type R, U, only DC voltage is available.
- * Power saving circuit is only available for the "Z" type.

Bracket

Nil: Without bracket
F : With bracket

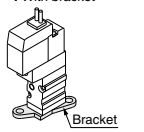

- * Bracket is mounted.
- * Brackets cannot be retrofitted.
- * External pilot type is not available.

Rated voltage

DC		CE-compliant
5	24 VDC	●
6	12 VDC	●
V	6 VDC	●
S	5 VDC	●
R	3 VDC	●

AC (50/60 Hz)		CE-compliant
1	100 VAC	—
2	200 VAC	—
3	110 VAC [115 VAC]	—
4	220 VAC [230 VAC]	—

- * For type W□, only DC voltage is available.
- Note) CE-compliant: For DC only.

Actuation type

1	Normally closed
2	Normally open

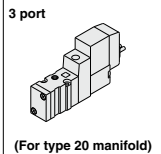

Body ported

Base mounted

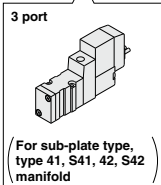

Body option

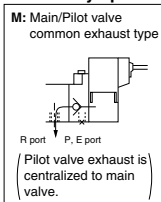

10-SYJ3 1 2 M □ - 5 M □ □ □ - M3 - □ □

10-SYJ3 1 4 M □ - 5 M □ □ □ - □ □ □ □

Clean series

Coil type

Nil	Standard
T	With power saving circuit (24, 12 VDC only)

- * Power saving circuit is not available for W□ type.

Port size

Nil: Without sub-plate M5: M5 port
With sub-plate

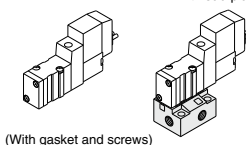

CE-compliant

Nil	—
Q	CE-compliant

Note) CE-compliant:
For DC only.

Electrical entry

24, 12, 6, 5, 3 VDC/100, 110, 200, 220 VAC			24, 12, 6, 5, 3 VDC	
Grommet	L plug connector	M plug connector	M8 connector	
G: Lead wire length 300 mm	L: With lead wire (Length 300 mm)	M: With lead wire (Length 300 mm)	MN: Without lead wire	
H: Lead wire length 600 mm	LN: Without lead wire	LO: Without connector	MO: Without connector	
			W□: With connector cable Note 1)	

- * LN, MN type: With 2 sockets.
- * Refer to page 642 for the lead wire length of L and M plug connectors.
- * Refer to page 645 for the connector assembly with cover for L and M plug connectors.
- * For connector cable of M8 connector, refer to page 646.
- * M8 connector conforming to IEC60947-5-2 is also available. Refer to page 640 for details.
- Note 1) Enter the cable length symbols in □. Please be sure to fill in the blank referring to page 646.

Manual override

Nil: Non-locking push type

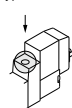

D: Push-turn locking slotted type

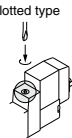

E: Push-turn locking lever type

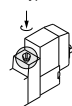

Note) When placing an order for body ported solenoid valves as a single unit, the mounting screws for the manifold and gasket are not attached. Order them separately, if necessary. (For details, refer to page 610.)

Construction

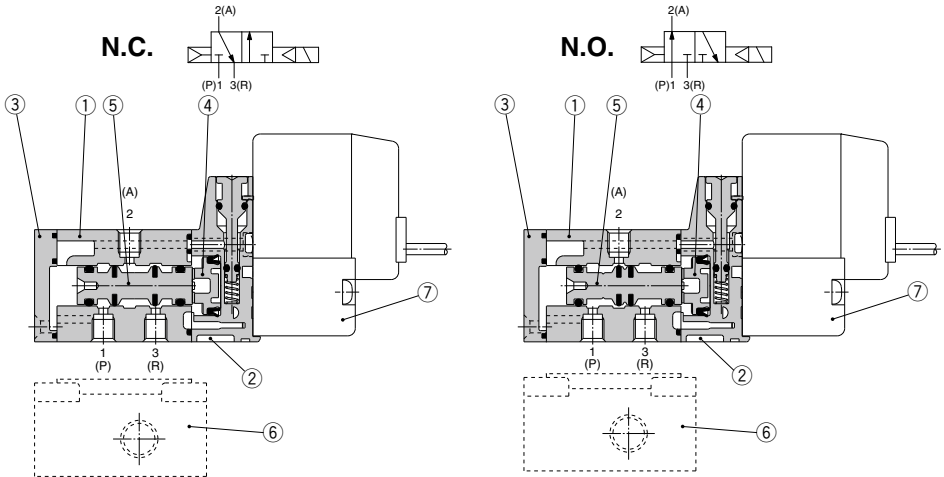

Component Parts

No.	Description	Material	Note
1	Body	Zinc die-casted	White
2	Piston plate	Resin	White
3	End cover	Resin	White
4	Piston	Resin	—
5	Spool valve assembly	Aluminum, H-NBR	—

Replacement Parts

No.	Description	Part no.	Note
6	Sub-plate ^{Note)}	SYJ300-9-1(-Q)	Zinc die-casted
7	Pilot valve	V111(T)-□□□□	—

(Note) Add suffix "-Q" for the CE-compliant product.

How to Order Pilot Valve Assembly

V111 □ — 5 G □ □

Coil type

Nil	Standard
T	With power saving circuit (24, 12 VDC only)

* Power saving circuit is not available for W□ type.

Rated voltage

5	24 VDC
6	12 VDC
V	6 VDC
S	5 VDC
R	3 VDC
1	100 VAC 50/60 Hz
2	200 VAC 50/60 Hz
3	110 VAC 50/60 Hz [115 VAC 50/60 Hz]
4	220 VAC 50/60 Hz [230 VAC 50/60 Hz]

* For type W□, only DC voltage is available.
* CE-compliant: For DC only.

Light/Surge voltage suppressor

Nil	Without light/surge voltage suppressor
S	With surge voltage suppressor
Z	With light/surge voltage suppressor
R	With surge voltage suppressor (Non-polar type)
U	With light/surge voltage suppressor (Non-polar type)

* For AC voltage valves there is no "S" option. It is already built into the rectifier circuit.
* For "R" and "U", only DC voltage is available.
* Power saving circuit is only available for the "Z" type.

Electrical entry

G	Grommet, 300 mm lead wire
H	Grommet, 600 mm lead wire
L	With lead wire
LN	L plug connector Without lead wire
LO	Without connector
M	With lead wire
MN	M plug connector Without lead wire
MO	Without connector
WO	M8 Without connector cable
W□	With connector cable ^{Note 1)}

* For connector cable of M8 connector, refer to page 646.
Note 1) Enter the cable length symbols in □. Please be sure to fill in the blank referring to page 646.

(Note) Since V111 is CE-compliant as standard, the suffix "-Q" is not necessary.

Directional Control Valves
Air Cylinders
Rotary Actuators
Air Grippers
Air Preparation Equipment
Modular F. R.
Pressure Control Equipment
Fittings & Tubing
Flow Control Equipment
Pressure Switches/Pressure Sensors

Body Ported

* [] for AC

Grommet (G), (H): 10-SYJ3□2M-□^G□□-M3

With bracket:
10-SYJ3□2M-□^G□□-M3-F

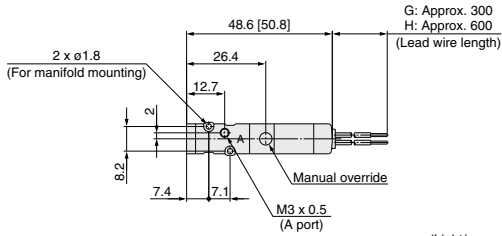

G: Approx. 300
H: Approx. 600
(Lead wire length)

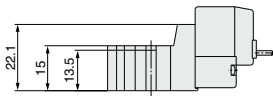
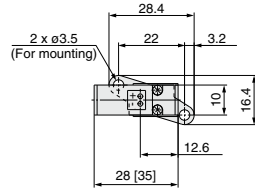

(Light/surge voltage suppressor)

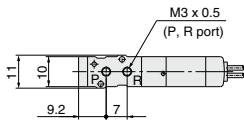
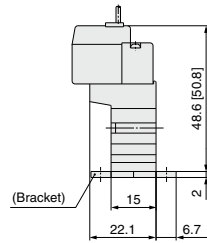
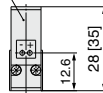

L plug connector (L):
10-SYJ3□2M-□L□□-M3

M plug connector (M):
10-SYJ3□2M-□M□□-M3

M8 connector (WO):
10-SYJ3□2M-□WO□□-M3

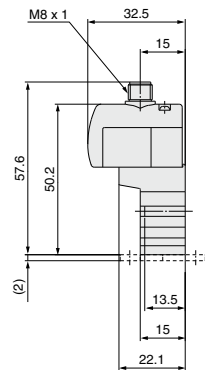
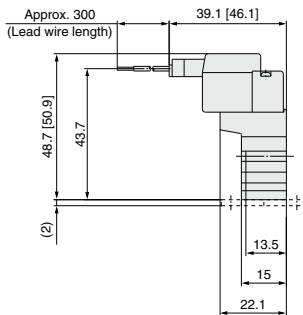
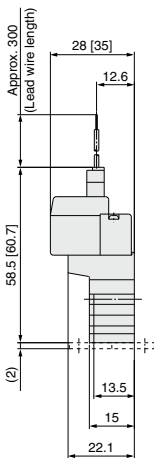

* Refer to page 646 for dimensions with connector cable.

Base Mounted (With Sub-plate)

* [] for AC

Grommet (G), (H): 10-SYJ3□4M-□^G□□-M5

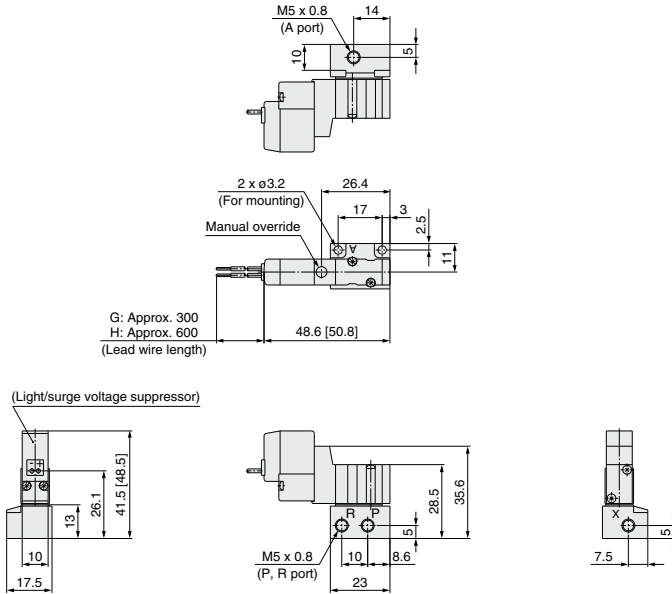

L plug connector (L):
10-SYJ3□4M-□L□□-M5

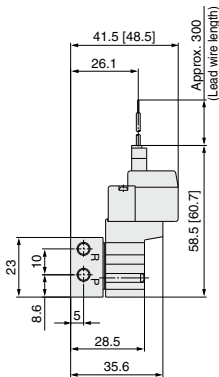

M plug connector (M):
10-SYJ3□4M-□M□□-M5

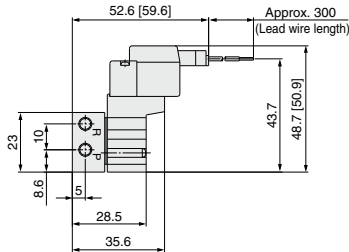

M8 connector (WO):
10-SYJ3□4M-□WO□□-M5

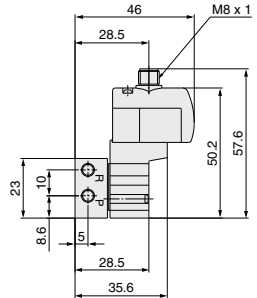

* Refer to page 646 for dimensions with connector cable.

Series 10-SYJ300 Manifold Specifications

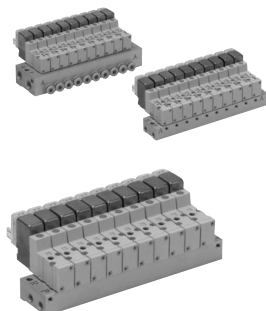

Manifold Specifications

Model	For internal pilot	Type 20	Type 41, S41	Type 42, S42
Manifold type		Single base/B mount		
P (SUP), R (EXH)		Common SUP/Common EXH		
Valve stations		2 to 20 stations		
A port Porting specifications	Location	Valve		Base
	Direction	Top		Side
Port size	P, R port	M5 x 0.8	M5 x 0.8	1/8
	A port	M3 x 0.5	M3 x 0.5	M5 x 0.8 C4 (ø4 One-touch fitting)

Flow Rate Characteristics

Manifold			Port size		Flow rate characteristics						Effective area (mm ²)
					1→2 (P→A)			2→3 (A→R)			
					C [dm ³ /(s·bar)]	b	Cv	C [dm ³ /(s·bar)]	b	Cv	
Body ported for internal pilot	Type 10-SS3YJ3-20	10-SYJ3□2M	M5 x 0.8	M3 x 0.5	—	—	—	—	—	—	0.9
	Type 10-SS3YJ3-41 S41	10-SYJ3□4M	M5 x 0.8	M3 x 0.5	—	—	—	—	—	—	1.5
Base mounted for internal pilot	Type 10-SS3YJ3-42-M5	10-SYJ3□4M	1/8	M5 x 0.8	0.31	0.17	0.075	0.32	0.11	0.072	—
	Type 10-SS3YJ3-42-C4			C4	0.33	0.36	0.086	0.33	0.2	0.082	—
	Type 10-SS3YJ3-S42-M5	10-SYJ3□4M	1/8	M5 x 0.8	0.32	0.3	0.079	0.33	0.35	0.086	—
	Type 10-SS3YJ3-S42-C4			C4	0.35	0.17	0.082	0.35	0.26	0.086	—

Note) The values are for individually operated 2 position type manifold bases.

How to Order Manifold (Example)

Instruct by specifying the valves and blanking plate assembly to be mounted on the manifold along with the manifold base model no.

(Example)

10-SS3YJ3-20-03 1 set (manifold base) 10-SS3YJ3-42-03-C4 1 set (manifold base)

* 10-SYJ312M-5LZ-M3 2 sets (valve) * 10-SYJ314M-5G 2 sets (valve)

* SYJ300-10-7A 1 set (blanking plate assembly) * SYJ300-10-7A 1 set (blanking plate assembly)

↳ The asterisk denotes the symbol for assembly. Prefix it to the part no. of the solenoid valve, etc.

Combinations of Solenoid Valve, Manifold Gasket and Manifold Base

Body ported (Type 10-SYJ3□2M(-Q))

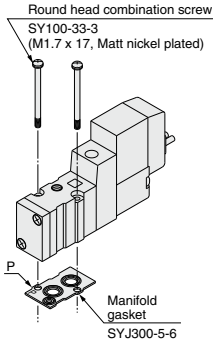

Applicable base
10-SS3YJ3-20(-Q)
Manifold base

Base mounted (Type 10-SYJ3□4M(-Q))

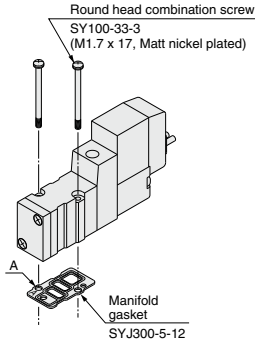

Applicable base
Sub-plate
10-SS3YJ3-41(-Q)
10-SS3YJ3-S41(-Q)
10-SS3YJ3-42(-Q)
10-SS3YJ3-S42(-Q) } Manifold base

Blanking Plate Assembly

Part no.: SYJ300-10-7A(-Q)

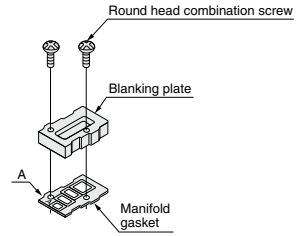

Applicable base
Sub-plate
10-SS3YJ3-20(-Q)
10-SS3YJ3-41(-Q)
10-SS3YJ3-S41(-Q)
10-SS3YJ3-42(-Q)
10-SS3YJ3-S42(-Q) } Manifold base

Note) Add suffix "-Q" for the CE-compliant product.

Caution

Mounting screw tightening torque

M1.7: 0.12 N·m

Use caution to the assembly orientation for solenoid valves, gasket and optional parts.

Directional Control Valves

Air Cylinders

Rotary Actuators

Air Grippers

Air Preparation Equipment

Modular F. R.

Pressure Control Equipment

Fittings & Tubing

Flow Control Equipment

Pressure Switches/ Pressure Sensors



Note) CE-compliant:
For DC only. [Option]

Manifold for Internal Pilot Type

Type 20

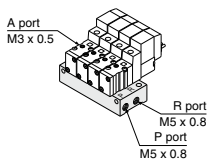

How to Order

10 - SS3YJ3 - 20 - 05 - [] - []

Clean series

Stations	
02	2 stations
:	:
20	20 stations

Bracket

Nil	Without bracket
F	With bracket

CE-compliant

Nil	—
Q	CE-compliant

Applicable solenoid valve
10-SYJ312M-□□□□-M3(-Q)
10-SYJ322M-□□□□-M3(-Q)

Applicable blanking
plate assembly

Refer to page 610.

Note) For more than 10 stations, supply air to both sides of P port and exhaust air from both sides of R port.

Type 41

Type 41

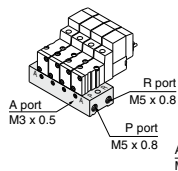

Type S41

(Pilot valve is on the A port side.)

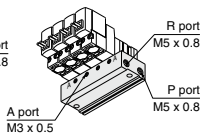

How to Order

10 - SS3YJ3 - [] 41 - 05 - M3 - []

Clean series

Valve mounting direction	
Nil	Pilot valve is opposite the A port side.
S	Pilot valve is on the A port side.

Stations	
02	2 stations
:	:
20	20 stations

CE-compliant

Nil	—
Q	CE-compliant

Applicable solenoid valve
10-SYJ314M-□□□□(-Q)
10-SYJ324M-□□□□(-Q)

Applicable blanking
plate assembly

Refer to page 610.

Note) For more than 10 stations, supply air to both sides of P port and exhaust air from both sides of R port.

Type 42

Type 42

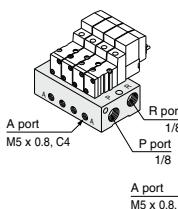

Type S42

(Pilot valve is on the A port side.)

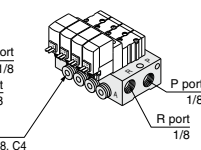

How to Order

10 - SS3YJ3 - [] 42 - 05 - M5 [] - []

Clean series

Valve mounting direction	
Nil	Pilot valve is opposite the A port side.
S	Pilot valve is on the A port side.

Stations	
02	2 stations
:	:
20	20 stations

CE-compliant

Nil	—
Q	CE-compliant

P, R port thread type

Nil	Rc
F	G
N	NPT
T	NPTF

A port size

M5	M5 x 0.8
C4	ø4 One-touch fitting
N3	ø5/32" One-touch fitting

Applicable solenoid valve
10-SYJ314M-□□□□(-Q)
10-SYJ324M-□□□□(-Q)

Applicable blanking
plate assembly

Refer to page 610.

Note) For more than 8 stations, supply/exhaust air to/from both sides of P port and R port.

Type 20 Manifold: Top Ported/10-SS3YJ3-20-Stations -00□ (-F)

* [] for AC

Grommet (G)

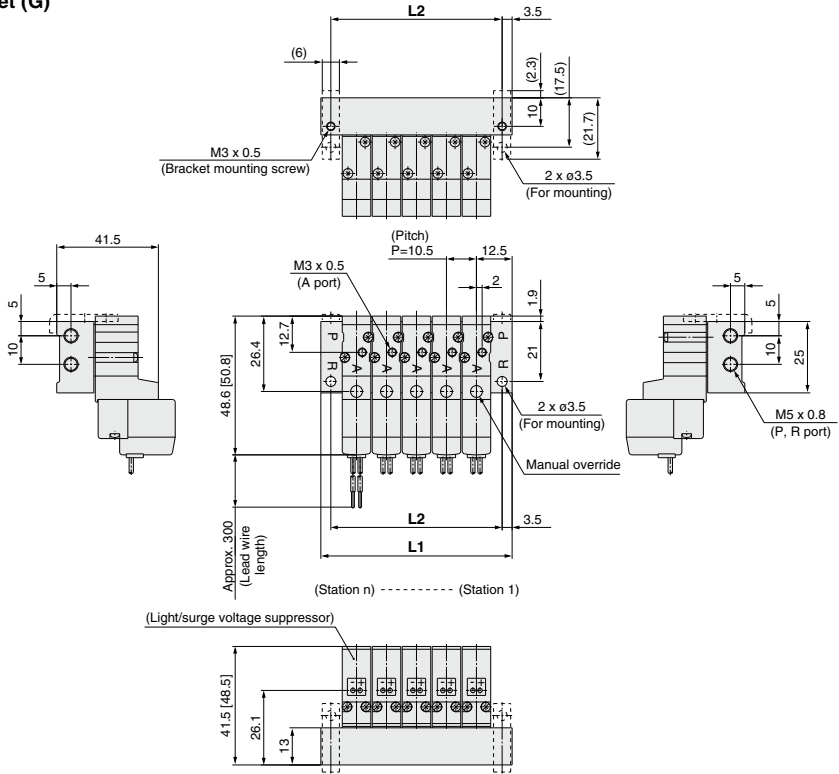

L plug connector (L)

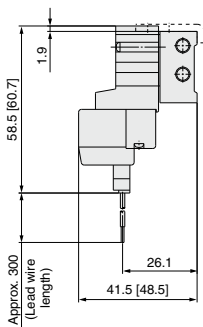

M plug connector (M)

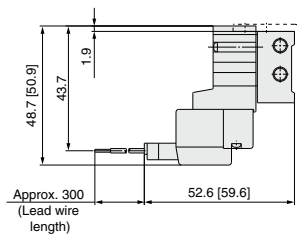

M8 connector (WO)

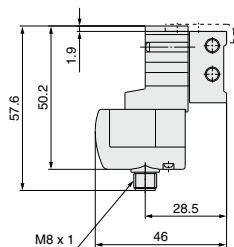

* Refer to page 646 for dimensions with connector cable.

Station	2	3	4	5	6	7	8	9	10	11	12	13	14	15	16	17	18	19	20
L1	35.5	46	56.5	67	77.5	88	98.5	109	119.5	130	140.5	151	161.5	172	182.5	193	203.5	214	224.5
L2	28.5	39	49.5	60	70.5	81	91.5	102	112.5	123	133.5	144	154.5	165	175.5	186	196.5	207	217.5

Directional Control Valves
Air Cylinders
Rotary Actuators
Air Grippers
Air Preparation Equipment
Modular F. R.
Pressure Control Equipment
Fittings & Tubing
Flow Control Equipment
Pressure Switches/ Pressure Sensors

Type 41 Manifold: Side Ported/10-SS3YJ3-41-Stations-M3

* [] for AC

Grommet (G)

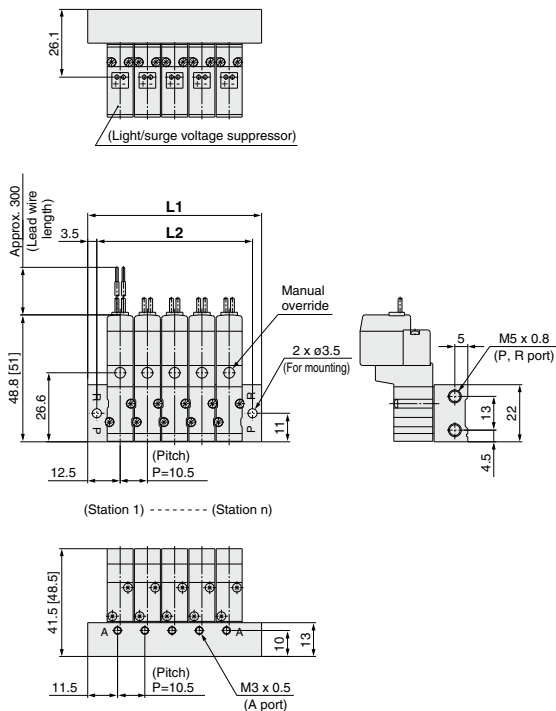

Type S41 Manifold: Side Ported

(Pilot valve is on the A port side)

10-SS3YJ3-S41-Stations-M3

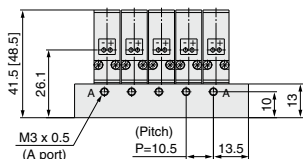
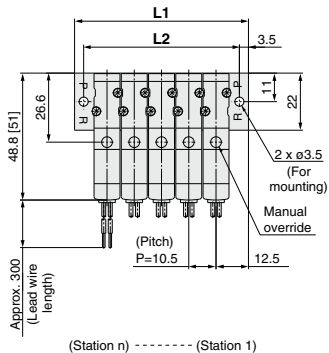

L plug connector (L)

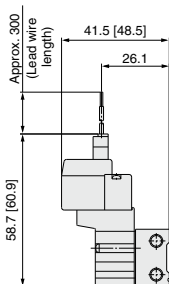

M plug connector (M)

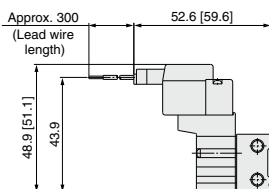

M8 connector (WO)

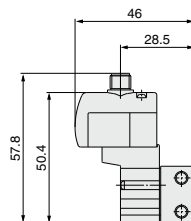

* Refer to page 646 for dimensions with connector cable.

Station	Station 2	3	4	5	6	7	8	9	10	11	12	13	14	15	16	17	18	19	Station 20
L1	35.5	46	56.5	67	77.5	88	98.5	109	119.5	130	140.5	151	161.5	172	182.5	193	203.5	214	224.5
L2	28.5	39	49.5	60	70.5	81	91.5	102	112.5	123	133.5	144	154.5	165	175.5	186	196.5	207	217.5

Type 42 Manifold: Side Ported/10-SS3YJ3-42-Stations-M5, C4 N3

* [] for AC

**Grommet (G)
For M5**

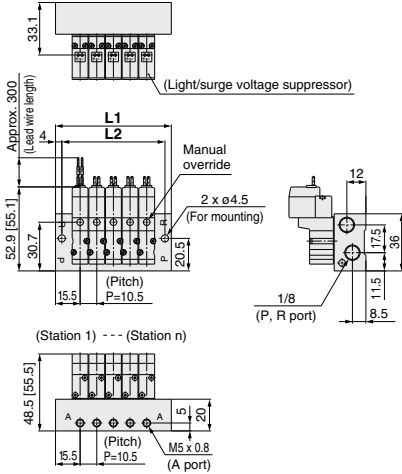

For C4 N3 (Built-in One-touch fitting)

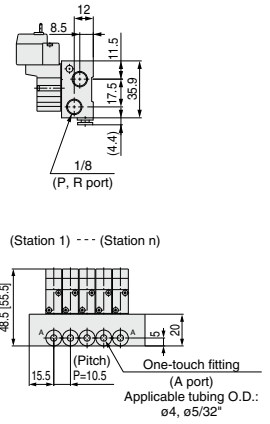

L plug connector (L)

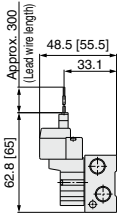

M plug connector (M)

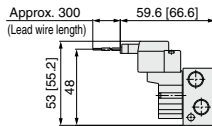

M8 connector (WO)

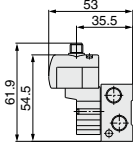

* Refer to page 646 for dimensions with connector cable.

Type S42 Manifold: Side Ported (Pilot valve is on the A port side)/10-SS3YJ3-S42-Stations-M5, C4 N3

**Grommet (G)
For M5**

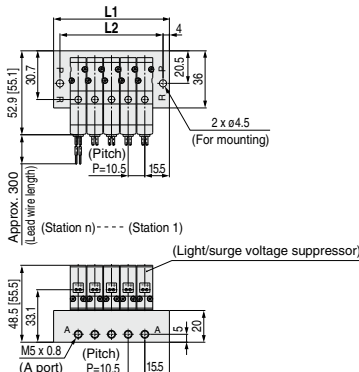

For C4 N3 (Built-in One-touch fitting)

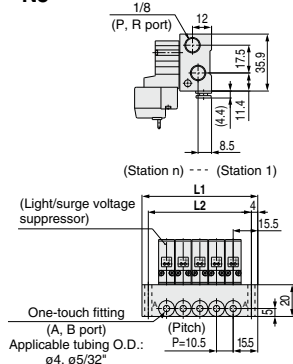

Station	Station 2	3	4	5	6	7	8	9	10	11	12	13	14	15	16	17	18	19	Station 20
L1	41.5	52	62.5	73	83.5	94	104.5	115	125.5	136	146.5	157	167.5	178	188.5	199	209.5	220	230.5
L2	33.5	44	54.5	65	75.5	86	96.5	107	117.5	128	138.5	149	159.5	170	180.5	191	201.5	212	222.5

Directional Control Valves
 Air Cylinders
 Rotary Actuators
 Air Grippers
 Air Preparation Equipment
 Modular F. R.
 Pressure Control Equipment
 Fittings & Tubing
 Flow Control Equipment
 Pressure Switches/ Pressure Sensors

Series 10-SYJ500

Rubber Seal
3 Port Pilot Solenoid Valve



Specifications

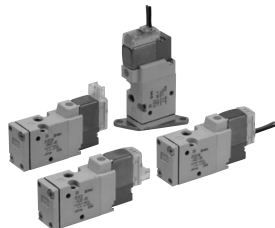

Body ported

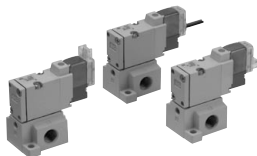

Base mounted

Fluid		Air
Operating pressure range (MPa)	Internal pilot	0.15 to 0.7
Ambient and fluid temperature (°C)		-10 to 50 (No freezing.)
Response time ms (at 0.5 MPa) ^{Note 1)}		25 or less
Max. operating frequency (Hz)		5
Manual override (Manual operation)		Non-locking push type, push-turn locking slotted type, push-turn locking lever type
Pilot exhaust method		Main/Pilot valve common exhaust
Lubrication		Not required
Mounting orientation		Unrestricted
Impact/Vibration resistance (m/s ²) ^{Note 2)}		150/30
Enclosure		Dust proof (* DIN terminal, M8 connector conforms to IP65.)

* Based on IEC60529

Note 1) Based on dynamic performance test, JIS B 8374-1981. (Coil temperature: 20°C, at rated voltage, without surge voltage suppressor.)

Note 2) Impact resistance: No malfunction occurred when it was tested in the axial direction and at right angles to the main valve and armature in both energized and de-energized states once for each condition. (Default settings)

Vibration resistance: No malfunction occurred in a one-sweep test between 45 and 2000 Hz. Test was performed in both energized and de-energized states in the axial direction and at right angles to the main valve and armature. (Default settings)

Solenoid Specifications

Symbol

Internal pilot

10-SYJ51²M

10-SYJ52²M

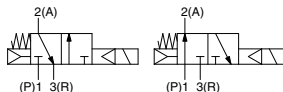

Made to Order
(For details, refer to page 640.)

Electrical entry		Grommet (G), (H), L plug connector (L), M plug connector (M), DIN terminal (D), (Y), M8 connector (W)	
		G, H, L, M, W	D, Y
Coil rated voltage (V)	DC	24, 12, 6, 5, 3	24, 12
	AC ^{50/60} Hz	100, 110, 200, 220	
Allowable voltage fluctuation		±10% of rated voltage *	
Power consumption (W)	DC	Standard	0.35 (With light: 0.4 (DIN terminal with light: 0.45))
		With power saving circuit	0.1 (With light only) * [Starting 0.4, Holding 0.1]
Apparent power (VA) *	AC	100 V	0.78 (With light: 0.81) 0.78 (With light: 0.87)
		110 V [115 V]	0.86 (With light: 0.89) 0.86 (With light: 0.97) [0.94 (With light: 1.07)]
		200 V	1.18 (With light: 1.22) 1.15 (With light: 1.30)
		220 V [230 V]	1.30 (With light: 1.34) 1.27 (With light: 1.46) [1.42 (With light: 1.46)] [1.39 (With light: 1.60)]
Surge voltage suppressor		Diode (DIN terminal, varistor when non-polar types)	
Indicator light		LED (Neon light when AC with DIN terminal)	

* Common between 110 VAC and 115 VAC, and between 220 VAC and 230 VAC.

* For 115 VAC and 230 VAC, the allowable voltage is -15% to +5% of rated voltage.

* For details, refer to page 643.

Flow Rate Characteristics/Weight

Valve model	Actuation type	Port size	Flow rate characteristics						Weight (g) ^{Note)}			
			1→2 (P→A)			2→3 (A→R)			Grommet	L/M plug connector	DIN terminal	M8 connector
			C [dm ³ /(s·bar)]	b	Cv	C [dm ³ /(s·bar)]	b	Cv				
Body ported	10-SYJ512M	N.C.	0.53	0.45	0.14	0.47	0.39	0.12	46	47	68	51
	10-SYJ522M	N.O.	0.66	0.45	0.18	0.66	0.45	0.18				
Base mounted (with sub-plate)	10-SYJ514M	N.C.	1.2	0.41	0.32	1.1	0.46	0.32	60 (46)	61 (47)	82 (68)	65 (51)
	10-SYJ524M	N.O.	1.3	0.37	0.33	1.2	0.48	0.34				

Note) Value for DC. Add 3 g for AC. (): Without sub-plate.

Note) AC-type models that are CE-compliant have DIN terminals only. [Option]



How to Order

Rated voltage

DC	
5	24 VDC
6	12 VDC
V	6 VDC
S	5 VDC
R	3 VDC

* DC specifications of type D, Y, DO and YO are only available with 12 and 24 VDC.

AC (50/60 Hz)	
1	100 VAC
2	200 VAC
3	110 VAC [115 VAC]
4	220 VAC [230 VAC]

* For type W□, only DC voltage is available. Note) AC-type models that are CE-compliant have DIN terminals only.

Actuation type

1	Normally closed
2	Normally open

Light/Surge voltage suppressor

Electrical entry for G, H, L, M and W

Nil	Without light/surge voltage suppressor
S	With surge voltage suppressor
Z	With light/surge voltage suppressor
R	With surge voltage suppressor (Non-polar type)
U	With light/surge voltage suppressor (Non-polar type)

* For AC voltage valves there is no "S" option. It is already built into the rectifier circuit.
* For type "R" and "U", only DC voltage is available.
* Power saving circuit is only available for the "Z" type.

Electrical entry for D, Y

Nil	Without light/surge voltage suppressor
S	With surge voltage suppressor (Non-polar type)
Z	With light/surge voltage suppressor (Non-polar type)

* DOZ and YOZ are not available.
* For AC voltage valves there is no "S" option. It is already built into the rectifier circuit.

Bracket

Nil	Without bracket
F	With bracket

* Bracket is not mounted.

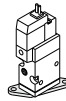

3 port



(For type 20 manifold)

Body ported

Base mounted

3 port



(For sub-plate type, type 40, 41 manifold)

Body option

M: Main/Pilot valve common exhaust type

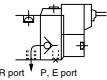

Clean series

Coil type

Nil	Standard
T	With power saving circuit (24, 12 VDC only)

* Power saving circuit is not available for D, Y, DO, YO or W□ types.

Manual override

Nil: Non-locking push type



D: Push-turn locking slotted type

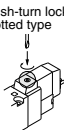

Port size

Nil: Without sub-plate 01: 1/8 port With sub-plate

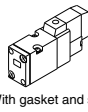

(With gasket and screws)

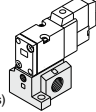

Thread type

Nil	Rc
F	G
N	NPT
T	NPTF

CE-compliant	
Nil	—
Q	CE-compliant

Note) AC-type models that are CE-compliant have DIN terminals only.

Electrical entry

24, 12, 6, 5, 3 VDC/100, 110, 200, 220 VAC				24, 12 VDC/100, 110, 200, 220 VAC		24, 12, 6, 5, 3 VDC
Grommet	L plug connector	M plug connector	MN: Without lead wire	DIN terminal	Y: With connector	M8 connector
G: Lead wire length 300 mm 	L: With lead wire (Length 300 mm) 	M: With lead wire (Length 300 mm) 	MO: Without connector 	DO: Without connector 	YO: Without connector 	WO: Without connector cable
H: Lead wire length 600 mm 	LN: Without lead wire 	LO: Without connector 				WI: With connector cable Note 1)
CE-compliant	DC	●	●	●	●	●
	AC	—	—	—	—	—

Note) When placing an order for body ported solenoid valves as a single unit, the mounting screws for the manifold and gasket are not attached. Order them separately, if necessary. (For details, refer to page 621.)

- * LN, MN type: With 2 sockets.
- * Refer to page 642 for the lead wire length of L and M plug connectors.
- * Refer to page 645 for the connector assembly with cover for L and M plug connectors.

* DIN terminal type "Y" which conforms to EN-175301-803C (former DIN43650C) is also available. For details, refer to page 644.

* For connector cable of M8 connector, refer to page 646.
* M8 connector conforming to IEC60947-5-2 is also available. Refer to page 640 for details.

Note 1) Enter the cable length symbols in □. Please be sure to fill in the blank referring to page 646.

Directional Control Valves

Air Cylinders

Rotary Actuators

Air Grippers

Air Preparation Equipment

Modular F. R.

Pressure Control Equipment

Fittings & Tubing

Flow Control Equipment

Pressure Switches/Pressure Sensors

Construction

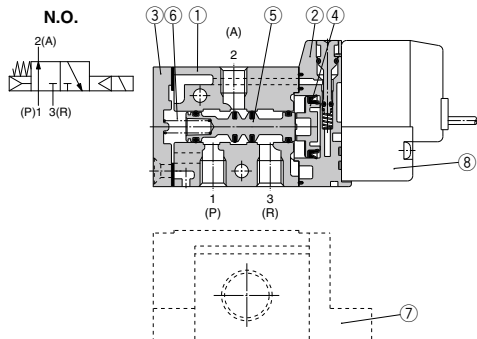
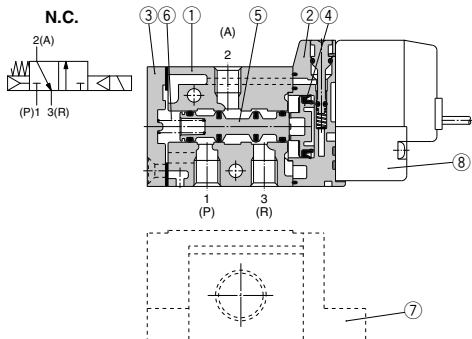

Component Parts

No.	Description	Material	Note
1	Body	Aluminum die-cast	White
2	Piston plate	Resin	White
3	End cover	Aluminum die-cast	White
4	Piston	Resin	—
5	Spool valve assembly	—	—
6	Spool spring	Stainless steel	—

Replacement Parts

No.	Description	Part no.	Note
7	Sub-plate ^(Note)	SYJ500-9-1(-Q)	Aluminum die-cast
8	Pilot valve	V111(T)□□□□	
—	Bracket assembly	SYJ5000-13-3A	

(Note) Add suffix "-Q" for the CE-compliant product.

How to Order Pilot Valve Assembly

V111 □ — 5 G □

Coil type

Nil	Standard
T	With power saving circuit (24, 12 VDC only)

* Power saving circuit is not available for W□ type.

Rated voltage

5	24 VDC
6	12 VDC
V	6 VDC
S	5 VDC
R	3 VDC
1	100 VAC 50/60 Hz
2	200 VAC 50/60 Hz
3	110 VAC 50/60 Hz [115 VAC 50/60 Hz]
4	220 VAC 50/60 Hz [230 VAC 50/60 Hz]

* For type W□, only DC voltage is available.
* CE-compliant: For DC only.

Light/Surge voltage suppressor

Nil	Without light/surge voltage suppressor
S	With surge voltage suppressor
Z	With light/surge voltage suppressor
R	With surge voltage suppressor (Non-polar type)
U	With light/surge voltage suppressor (Non-polar type)

* For AC voltage valves there is no "S" option. It is already built into the rectifier circuit.

* For "R" and "U", only DC voltage is available.

* Power saving circuit is only available for the "Z" type.

Electrical entry

G	Grommet, 300 mm lead wire
H	Grommet, 600 mm lead wire
L	With lead wire
LN	Without lead wire
LO	Without connector
M	With lead wire
MN	M plug connector Without lead wire
MO	Without connector
WO	M8 Without connector cable
W□	connector With connector cable ^(Note 1)

* For connector cable of M8 connector, refer to page 646.

Note 1) Enter the cable length symbols in □. Please be sure to fill in the blank referring to page 646.

V115 — 5 D □

Light/Surge voltage suppressor

Nil	Without light/surge voltage suppressor
S	With surge voltage suppressor (Non-polar type)
Z	With light/surge voltage suppressor (Non-polar type)

* DOZ and YOZ are not available.

* For AC voltage valves there is no "S" option. It is already built into the rectifier circuit.

Electrical entry

D	DIN terminal	With connector
DO	(Type D)	Without connector
Y	DIN terminal	With connector
YO	(Type Y)	Without connector

* Do not replace V111 (G, H, L, M, W) with V115 (DIN terminal) and vice versa when replacing pilot valve assembly only.

Rated voltage

5	24 VDC
6	12 VDC
1	100 VAC 50/60 Hz
2	200 VAC 50/60 Hz
3	110 VAC 50/60 Hz [115 VAC 50/60 Hz]
4	220 VAC 50/60 Hz [230 VAC 50/60 Hz]

* DC specifications of type D and DO are only available with 12 and 24 VDC.

* Power saving circuit is not available for D or DO types.

Note) Since V111 and V115 are CE-compliant as standard, the suffix "-Q" is not necessary.

Body Ported

* [] for AC

Grommet (G), (H): 10-SYJ5□2M-□^G_H□□-M5

With bracket:
10-SYJ5□2M-□^G_H□□-M5-F

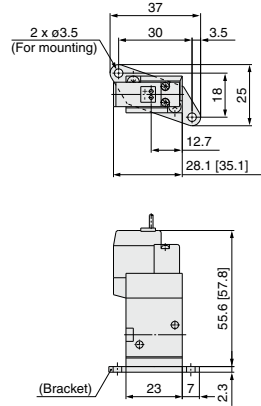
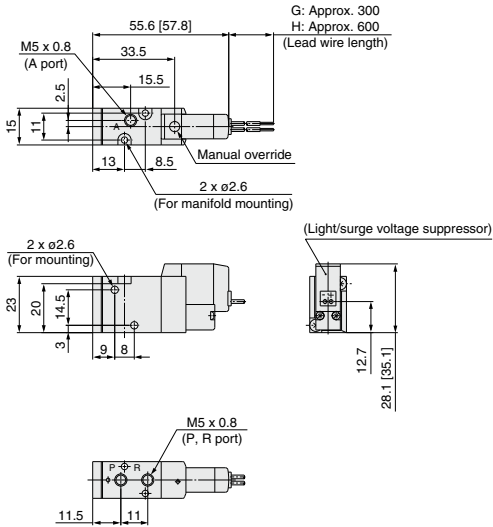

L plug connector (L):
10-SYJ5□2M-□L□□-M5 (-F)

M plug connector (M):
10-SYJ5□2M-□M□□-M5 (-F)

DIN terminal (D,Y):
10-SYJ5□2M-□D□□-M5 (-F)

M8 connector (WO):
10-SYJ5□2M-□WO□□-M5 (-F)

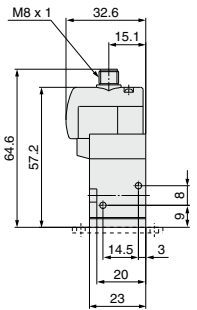
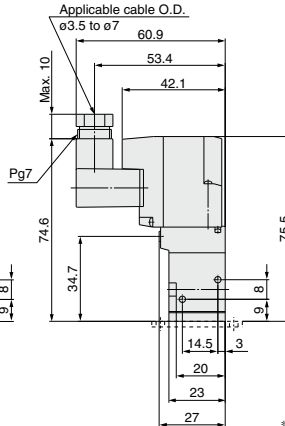
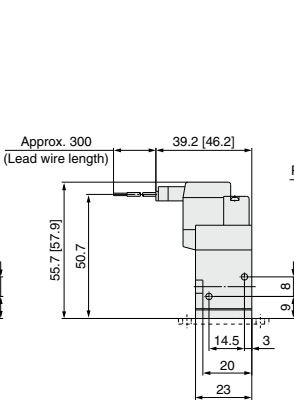
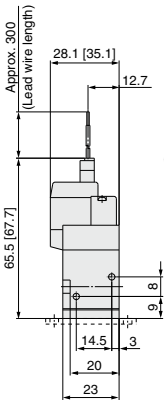

* Refer to page 646 for dimensions with connector cable.

Directional Control Valves

Air Cylinders

Rotary Actuators

Air Grippers

Air Preparation Equipment

Modular F. R.

Pressure Control Equipment

Fittings & Tubing

Flow Control Equipment

Pressure Switches/ Pressure Sensors

Base Mounted (With Sub-plate)

* [] for AC

Grommet (G), (H): 10-SYJ5□4M-□^G□□-01□

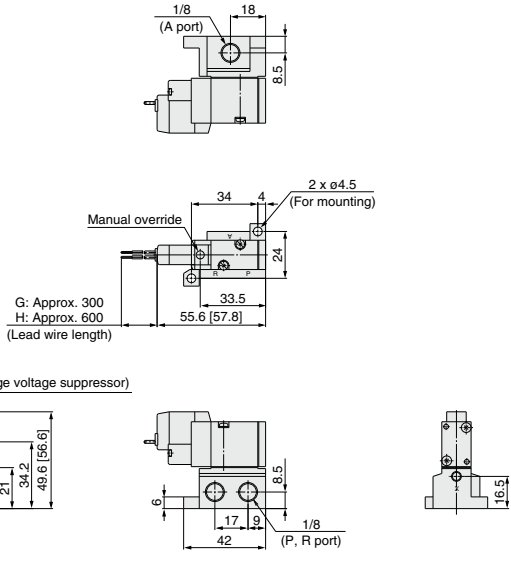

L plug connector (L): 10-SYJ5□4M-□L□□-01□ **M plug connector (M): 10-SYJ5□4M-□M□□-01□** **DIN terminal (D, Y): 10-SYJ5□4M-□^D□□-01□** **M8 connector (WO): 10-SYJ5□4M-□WO□□-01□**

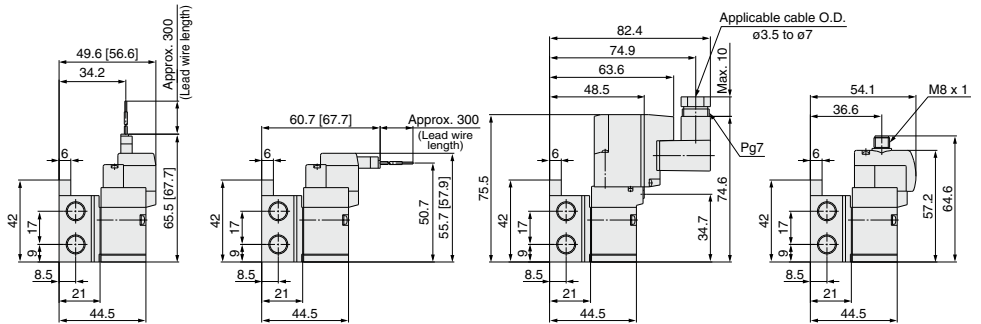

* Refer to page 646 for dimensions with connector cable.

Series 10-SYJ500 Manifold Specifications

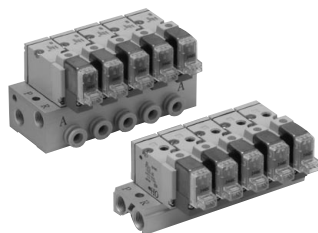

Manifold Specifications

Model	For internal pilot	Type 20	Type 40	Type 41
Manifold type		Single base/B mount		
P (SUP), R (EXH)		Common SUP, common EXH		
Valve stations		2 to 20 stations		
A port Porting specifications	Location	Valve		Base
	Direction	Top	Bottom	Side
	P, R port	1/8	1/8	1/8
Port size	A port	M5 x 0.8	M5 x 0.8 1/8	M5 x 0.8, 1/8, C4 (ø4 One-touch fitting), C6 (ø6 One-touch fitting)

Flow Rate Characteristics

Manifold			Port size		Flow rate characteristics					
					1→2 (P→A)			2→3 (A→R)		
			1(P), 3(R) port	2(A) port	C [dm ³ /(sbar)]	b	Cv	C [dm ³ /(sbar)]	b	Cv
Body ported for internal pilot	Type 10-SS3YJ5-20	10-SYJ5□2M	1/8	M5 x 0.8	0.47	0.43	0.13	0.74	0.32	0.19
	Type 10-SS3YJ5-40-M5	10-SYJ5□4M	1/8	M5 x 0.8	0.71	0.52	0.21	0.81	0.28	0.20
Type 10-SS3YJ5-40-01	1/8		1/8	0.98	0.36	0.25	0.92	0.24	0.22	
Type 10-SS3YJ5-41-M5	1/8		M5 x 0.8	0.71	0.49	0.20	0.80	0.23	0.19	
Type 10-SS3YJ5-41-01	1/8		1/8	1.0	0.37	0.26	0.96	0.25	0.24	
Type 10-SS3YJ5-41-C4	1/8		C4	0.68	0.35	0.17	1.0	0.25	0.24	
Type 10-SS3YJ5-41-C6	1/8		C6	1.0	0.27	0.25	1.0	0.30	0.26	

Note) The values are for individually operated 2 position type manifold bases.

How to Order Manifold (Example)

Instruct by specifying the valves and blanking plate assembly to be mounted on the manifold along with the manifold base model no.

(Example)

10-SS3YJ5-20-03 1 set (manifold base) 10-SS3YJ5-41-03-C6 1 set (manifold base)

* 10-SYJ512M-5LZ-M5 2 sets (valve) * 10-SYJ514M-5G 2 sets (valve)

* SYJ500-10-1A 1 set (blanking plate assembly) * SYJ500-10-3A 1 set (blanking plate assembly)

↳ The asterisk denotes the symbol for assembly. Prefix it to the part no. of the solenoid valve, etc.

Combinations of Solenoid Valve, Manifold Gasket and Manifold Base

Body ported (Type 10-SYJ5□2M(-Q))

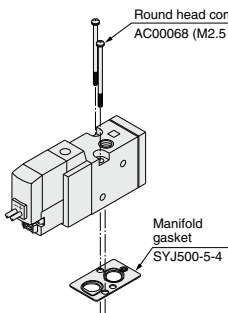

Applicable base
Type 10-SS3YJ5-20(-Q)
Manifold base

Base mounted (Type 10-SYJ5□4M(-Q))

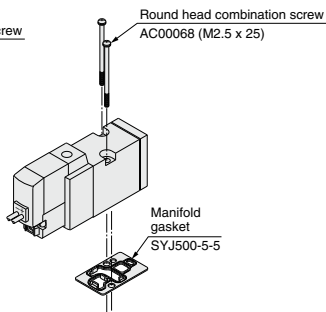

Applicable base
Sub-plate
Type 10-SS3YJ5-40(-Q) } Manifold
Type 10-SS3YJ5-41(-Q) } base

Blanking Plate Assembly

Part no.: SYJ500-10-3A(-Q)

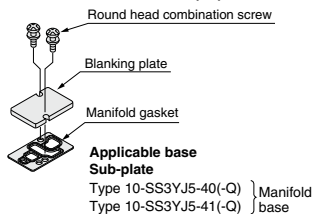

Applicable base
Sub-plate
Type 10-SS3YJ5-40(-Q) } Manifold
Type 10-SS3YJ5-41(-Q) } base

Part no.: SYJ500-10-1A(-Q)

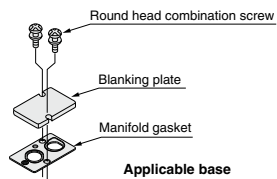

Applicable base
Type 10-SS3YJ5-20(-Q)

⚠ Caution

Mounting screw tightening torque

M2.5: 0.45 N·m

Use caution to the assembly orientation for solenoid valves (blanking plate) and manifold gasket.

Note) Add suffix "-Q" for the CE-compliant product.



Note) AC-type models that are CE-compliant have DIN terminals only. [Option]

Manifold for Internal Pilot Type

Type 20

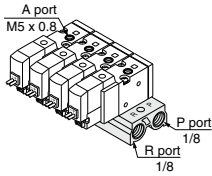

How to Order

10 - SS3YJ5 - 20 - 05 - [] - [] - []

↓ Clean series

Stations	P, R port thread type	Bracket	CE-compliant
02 2 Stations	Nll Rc	Nll Without bracket	Nll -
: :	00F G	F With bracket	Q CE-compliant
20 20 Stations	00N NPT		
	00T NPTF		

Applicable solenoid valve
10-SYJ512M-□□□□-M5(-Q)
10-SYJ522M-□□□□-M5(-Q)

Applicable blanking plate assembly
Refer to page 621.

Note) For more than 6 stations, supply air to both sides of P port and exhaust air from both sides of R port.

Type 40

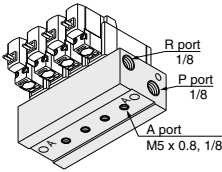

How to Order

10 - SS3YJ5 - 40 - 05 M5 - [] - []

↓ Clean series

Stations	A port size	P, R port thread type	CE-compliant
02 2 Stations	M5 M5 x 0.8	Nll Rc	Nll -
: :	01 1/8	F G	Q CE-compliant
20 20 Stations		N NPT	
		T NPTF	

Applicable solenoid valve
10-SYJ514M-□□□□(-Q)
10-SYJ524M-□□□□(-Q)

Applicable blanking plate assembly
Refer to page 621.

Note) For more than 9 stations, supply air to both sides of P port and exhaust air from both sides of R port.

Type 41

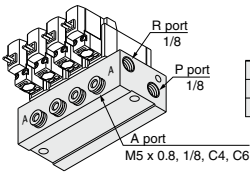

How to Order

10 - SS3YJ5 - 41 - 05 - C6 - [] - []

↓ Clean series

Stations	A port size	P, R port thread type	CE-compliant
02 2 Stations	M5 M5 x 0.8	Nll Rc	Nll -
: :	01 1/8	F G	Q CE-compliant
20 20 Stations	C4 e4 One-touch fitting	N NPT	
	C6 e6 One-touch fitting	T NPTF	
	N3 e5/32" One-touch fitting		
	N7 e1/4" One-touch fitting		

Applicable solenoid valve
10-SYJ514M-□□□□(-Q)
10-SYJ524M-□□□□(-Q)

Applicable blanking plate assembly
Refer to page 621.

Note) For more than 9 stations, supply air to both sides of P port and exhaust air from both sides of R port.

Directional Control Valves

Air Cylinders

Rotary Actuators

Air Grippers

Air Preparation Equipment

Modular F. R.

Pressure Control Equipment

Fittings & Tubing

Flow Control Equipment

Pressure Switches/ Pressure Sensors

Type 20 Manifold: Top Ported/10-SS3YJ5-20-Stations -00 □ (-F)

* [] for AC

Grommet (G)

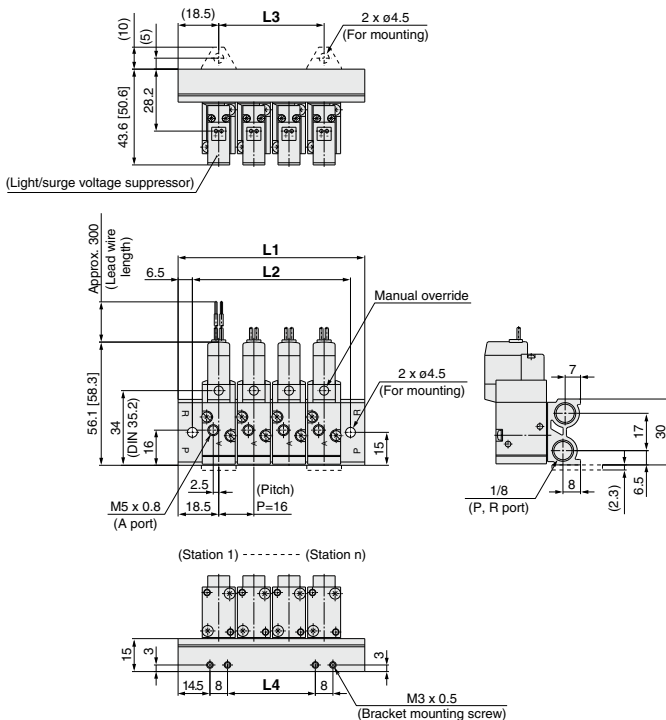

L plug connector (L)

M plug connector (M)

DIN terminal (D, Y)

M8 connector (WO)

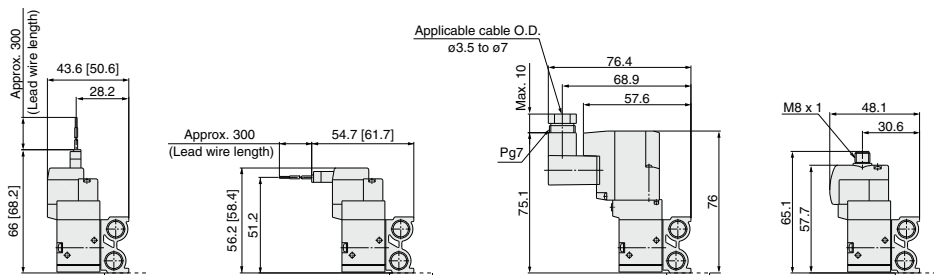

* Refer to page 646 for dimensions with connector cable.

Station	Station 2	3	4	5	6	7	8	9	10	11	12	13	14	15	16	17	18	19	Station 20
L1	53	69	85	101	117	133	149	165	181	197	213	229	245	261	277	293	309	325	341
L2	40	56	72	88	104	120	136	152	168	184	200	216	232	248	264	280	296	312	328
L3	16	32	48	64	80	96	112	128	144	160	176	192	208	224	240	256	272	288	304
L4	8	24	40	56	72	88	104	120	136	152	168	184	200	216	232	248	264	280	296

Type 40 Manifold: Bottom Ported/10-SS3YJ5-40-Stations-M5, 01□

* [] for AC

Grommet (G)

For 1/8

For M5

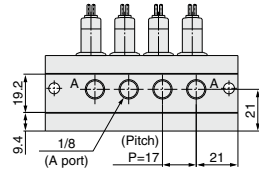
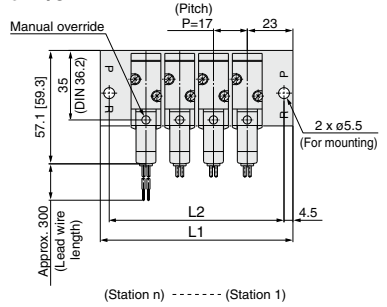
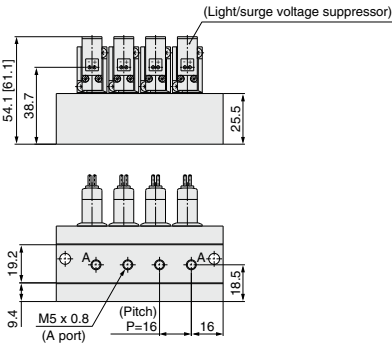
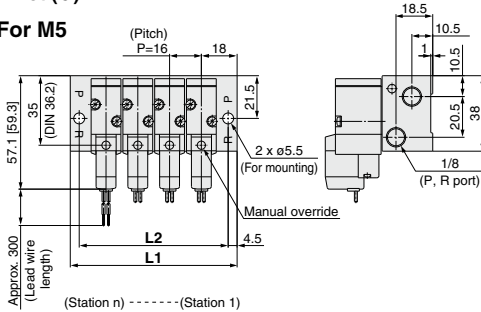

L plug connector (L)

M plug connector (M)

DIN terminal (D, Y)

M8 connector (WO)

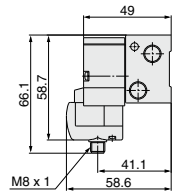
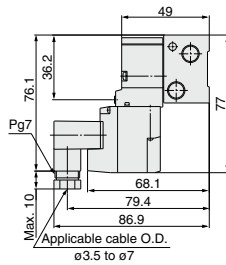
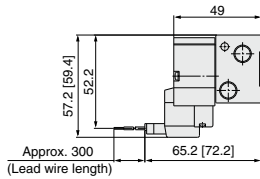
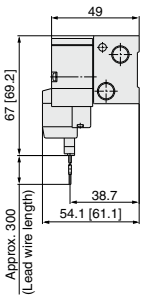

* Refer to page 646 for dimensions with connector cable.

Port size	Station	Station 2	3	4	5	6	7	8	9	10	11	12	13	14	15	16	17	18	19	Station 20
M5	L1	52	68	84	100	116	132	148	164	180	196	212	228	244	260	276	292	308	324	340
	L2	43	59	75	91	107	123	139	155	171	187	203	219	235	251	267	283	299	315	331
1/8	L1	63	80	97	114	131	148	165	182	199	216	233	250	267	284	301	318	335	352	369
	L2	54	71	88	105	122	139	156	173	190	207	224	241	258	275	292	309	326	343	360

Directional Control Valves
 Air Cylinders
 Rotary Actuators
 Air Grippers
 Air Preparation Equipment
 Modular F. R.
 Pressure Control Equipment
 Fittings & Tubing
 Flow Control Equipment
 Pressure Switches/ Pressure Sensors

Type 41 Manifold: Side Ported/10-SS3YJ5-41- Stations C4, N3
 C6, N7

* [] for AC

Grommet (G)

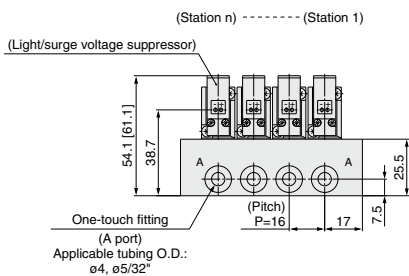
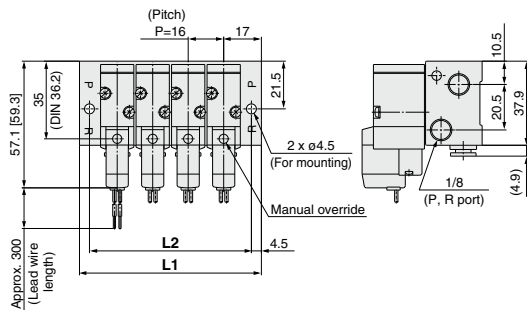

L plug connector (L)

M plug connector (M)

DIN terminal (D, Y)

M8 connector (WO)

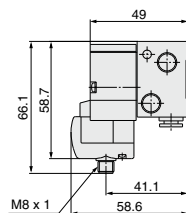
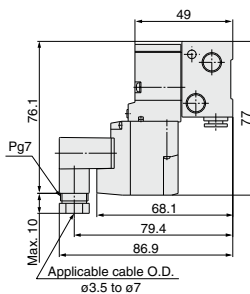
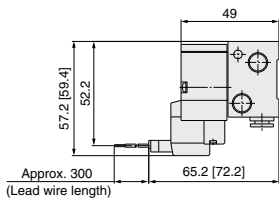
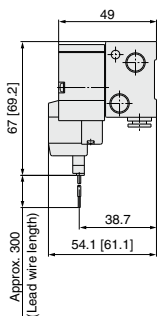

* Refer to page 646 for dimensions with connector cable.

Port size	Station	Station 2	3	4	5	6	7	8	9	10	11	12	13	14	15	16	17	18	19	Station 20
One-touch fitting	L1	50	66	82	98	114	130	146	162	178	194	210	226	242	258	274	290	306	322	338
	L2	41	57	73	89	105	121	137	153	169	185	201	217	233	249	265	281	297	313	329

Type 41 Manifold: Side Ported/10-SS3YJ5-41- Stations -M5, 01 □

* [] for AC

Grommet (G)
For M5

For 1/8

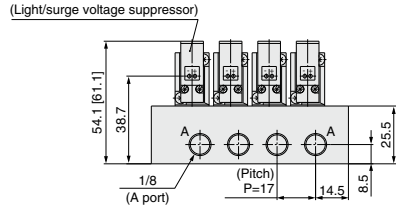
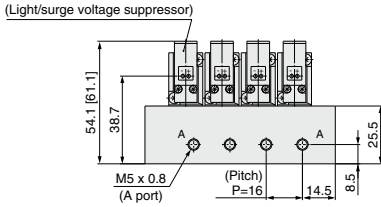
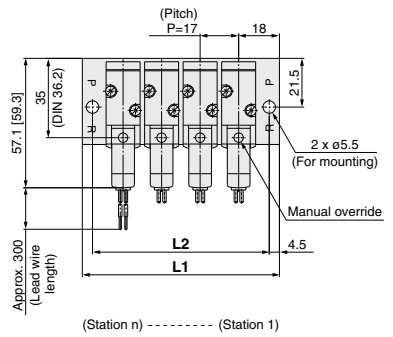
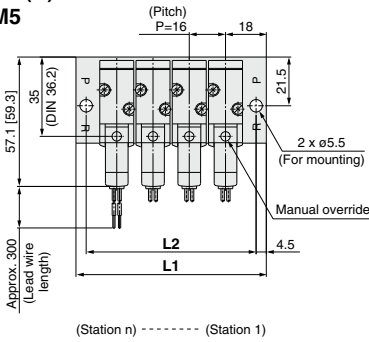

Port size	Station	Station 2	3	4	5	6	7	8	9	10	11	12	13	14	15	16	17	18	19	Station 20
		M5	L1	52	68	84	100	116	132	148	164	180	196	212	228	244	260	276	292	308
	L2	43	59	75	91	107	123	139	155	171	187	203	219	235	251	267	283	299	315	331
1/8	L1	53	70	87	104	121	138	155	172	189	206	223	240	257	274	291	308	325	342	359
	L2	44	61	78	95	112	129	146	163	180	197	214	231	248	265	282	299	316	333	350

Directional Control Valves

Air Cylinders

Rotary Actuators

Air Grippers

Air Preparation Equipment

Modular F. R.

Pressure Control Equipment

Fittings & Tubing

Flow Control Equipment

Pressure Switches/ Pressure Sensors

Series 10-SYJ700

Rubber Seal
3 Port Pilot Solenoid Valve



Specifications

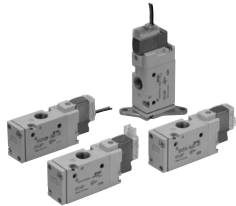

Body ported

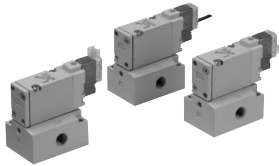

Base mounted

Fluid		Air
Operating pressure range (MPa)	Internal pilot	0.15 to 0.7
Ambient and fluid temperature (°C)		-10 to 50 (No freezing.)
Response time ms (at 0.5 MPa) ^{Note 1)}		30 or less
Max. operating frequency (Hz)		5
Manual override (Manual operation)		Non-locking push type, push-turn locking slotted type, push-turn locking lever type
Pilot exhaust method		Main/Pilot valve common exhaust
Lubrication		Not required
Mounting orientation		Unrestricted
Impact/Vibration resistance (m/s²) ^{Note 2)}		150/30
Enclosure		Dust proof (* DIN terminal, M8 connector: IP65)

* Based on IEC60529

Note 1) Based on dynamic performance test, JIS B 8374-1981. (Coil temperature: 20°C, at rated voltage, without surge voltage suppressor.)

Note 2) Impact resistance: No malfunction occurred when it was tested in the axial direction and at right angles to the main valve and armature in both energized and de-energized states once for each condition. (Default settings)

Vibration resistance: No malfunction occurred in a one-sweep test between 45 and 2000 Hz. Test was performed in both energized and de-energized states in the axial direction and at right angles to the main valve and armature. (Default settings)

Symbol

Internal pilot

10-SYJ71²M

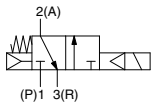

10-SYJ72²M

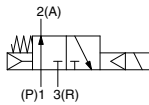

Made to Order

(For details, refer to page 640.)

Solenoid Specifications

Electrical entry		Grommet (G), (H), L plug connector (L), M plug connector (M), DIN terminal (D), (Y), M8 connector (W)	
		G, H, L, M, W	D, Y
Coil rated voltage (V)	DC	24, 12, 6, 5, 3	
	AC ^{50/60} Hz	100, 110, 200, 220	
Allowable voltage fluctuation		±10% of rated voltage *	
Power consumption (W)	DC	0.35 (With light: 0.4 (DIN terminal with light: 0.45))	
	Standard	0.1 (With light only) * [Starting 0.4, Holding 0.1]	
Apparent power (VA) *	AC	100 V	0.78 (With light: 0.81) 0.78 (With light: 0.87)
		110 V [115 V]	0.86 (With light: 0.89) 0.86 (With light: 0.97) [0.94 (With light: 0.97)] [0.94 (With light: 1.07)]
		200 V	1.18 (With light: 1.22) 1.15 (With light: 1.30)
		220 V [230 V]	1.30 (With light: 1.34) 1.27 (With light: 1.46) [1.42 (With light: 1.46)] [1.39 (With light: 1.60)]
Surge voltage suppressor		Diode (DIN terminal, varistor when non-polar types)	
Indicator light		LED (Neon light when AC with DIN terminal)	

* Common between 110 VAC and 115 VAC, and between 220 VAC and 230 VAC.

* For 115 VAC and 230 VAC, the allowable voltage is -15% to +5% of rated voltage.

* For details, refer to page 643.

Flow Rate Characteristics/Weight

Valve model	Type of actuation	Port size	Flow rate characteristics						Weight (g) ^{Note)}				
			1→2 (P→A)			2→3 (A→R)			Grommet	L/M plug connector	DIN terminal	M8 connector	
			C [dm ³ /(s·bar)]	b	Cv	C [dm ³ /(s·bar)]	b	Cv					
Body ported	10-SYJ712M	N.C.	1/8	2.8	0.43	0.77	2.5	0.51	0.76	75	76	97	80
				2.7	0.38	0.72	2.4	0.42	0.69				
				2.9	0.32	0.71	2.7	0.34	0.69				
Base mounted (with sub-plate)	10-SYJ714M	N.C.	1/8	2.8	0.21	0.70	2.3	0.45	0.63	135 (75)	136 (76)	157 (97)	140 (80)
				3.0	0.31	0.74	2.6	0.33	0.66				
	10-SYJ724M	N.O.	1/4	2.7	0.31	0.68	2.3	0.48	0.64				

Note) Value for DC. Add 3 g for AC. (): Without sub-plate.

Note) AC-type models that are CE-compliant have DIN terminals only. [Option]



How to Order

Rated voltage

DC	
5	24 VDC
6	12 VDC
V	6 VDC
S	5 VDC
R	3 VDC

* DC specifications of type D, Y, DO and YO are only available with 12 and 24 VDC.

AC (50/60 Hz)

1	100 VAC
2	200 VAC
3	110 VAC [115 VAC]
4	220 VAC [230 VAC]

* For type W□, only DC voltage is available.
Note) AC-type models that are CE-compliant have DIN terminals only.

Light/Surge voltage suppressor

Nil	Without light/surge voltage suppressor
S	With surge voltage suppressor
Z	With light/surge voltage suppressor
R	With surge voltage suppressor (Non-polar type)
U	With light/surge voltage suppressor (Non-polar type)

* For AC voltage valves there is no "S" option. It is already built into the rectifier circuit.
* For type "R" and "U", only DC voltage is available.
* Power saving circuit is only available for the "Z" type.

Electrical entry for D, Y

Nil	Without light/surge voltage suppressor
S	With surge voltage suppressor (Non-polar type)
Z	With light/surge voltage suppressor (Non-polar type)

* DO2 and YO2 are not available.
* For AC voltage valves there is no "S" option. It is already built into the rectifier circuit.

Actuation type

1	Normally closed
2	Normally open

3 port

(For type 20 manifold)

Thread type

Nil	Rc
F	G
N	NPT
T	NPTF

Bracket

Nil	Without bracket
F	With bracket

* Bracket is not mounted.

Body option

M: Main/Pilot valve common exhaust type

R port P, E port

Body ported

10-SYJ7 1 2 M □ - 5 M □ - 01 □ - □ - □

Base mounted

10-SYJ7 1 4 M □ - 5 M □ - 01 □ - □ - □

Clean series

Coil type

Nil	Standard
T	With power saving circuit (24, 12 VDC only)

* Power saving circuit is not available for D, Y, DO, YO or W□ types.

Manual override

Nil: Non-locking push type

D: Push-turn locking slotted type

E: Push-turn locking lever type

Thread type

Nil	Rc
F	G
N	NPT
T	NPTF

Port size

Nil: Without sub-plate

01: 1/8 port With sub-plate

02: 1/4 port With sub-plate

(With gasket and screws)

CE-compliant

Nil	-
Q	CE-compliant

Note) AC-type models that are CE-compliant have DIN terminals only.

Electrical entry

CE-compliant	24, 12, 6, 5, 3 VDC/100, 110, 200, 220 VAC				24, 12 VDC/100, 110, 200, 220 VAC		24, 12, 6, 5, 3 VDC	
	Grommet	L plug connector	M plug connector	DIN terminal	M8 connector	M8 connector	M8 connector	
	G: Lead wire length 300 mm	L: With lead wire (Length 300 mm)	M: With lead wire (Length 300 mm)	MN: Without lead wire	D: With connector	Y: With connector	WO: Without connector cable	
	H: Lead wire length 600 mm	LN: Without lead wire	MO: Without connector	DO: Without connector	YO: Without connector	W□: With connector cable (Note 1)		
		LO: Without connector						

Note) When placing an order for body ported solenoid valves as a single unit, the mounting screws for the manifold and gasket are not attached. Order them separately, if necessary. (For details, refer to page 633.)

* LN, MN type: With 2 sockets.
* Refer to page 642 for the lead wire length of L and M plug connectors.
* Refer to page 645 for the connector assembly with cover for L and M plug connectors.

* DIN terminal type "Y" which conforms to EN-175301-803C (former DIN4365C) is also available. For details, refer to page 644.
* For connector cable of M8 connector, refer to page 646.
* M8 connector conforming to IEC60947-5-2 is also available. Refer to page 640 for details.
Note 1) Enter the cable length symbols in □. Please be sure to fill in the blank referring to page 646.

Directional Control Valves
 Air Cylinders
 Rotary Actuators
 Air Grippers
 Air Preparation Equipment
 Modular F. R.
 Pressure Control Equipment
 Fittings & Tubing
 Flow Control Equipment
 Pressure Switches/Pressure Sensors

Construction

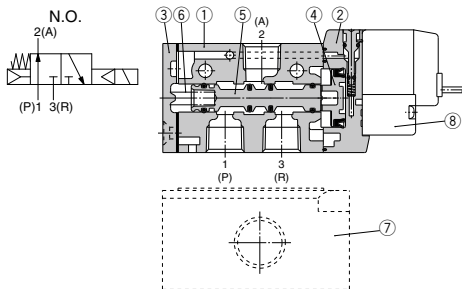
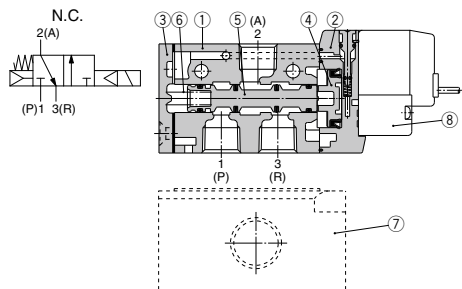

Component Parts

No.	Description	Material	Note
1	Body	Aluminum die-casted	White
2	Piston plate	Resin	White
3	End cover	Aluminum die-casted	White
4	Piston	Resin	—
5	Spool valve assembly	—	—
6	Spool spring	Stainless steel	—

Replacement Parts

No.	Description	Part no.	Note
7	Sub-plate ^(Note)	SYJ700-9-1(-Q)	1/8 Aluminum die-casted
		SYJ700-9-2(-Q)	1/4
8	Pilot valve	V111(T)-□□□□	
—	Bracket assembly	SYJ700-19-1A	

Note) Add suffix "-Q" for the CE-compliant product.

How to Order Pilot Valve Assembly

V111 □ — 5 G □

Coil type

NII	Standard
T	With power saving circuit (24, 12 VDC only)

* Power saving circuit is not available for W□ type.

Rated voltage

5	24 VDC
6	12 VDC
V	6 VDC
S	5 VDC
R	3 VDC
1	100 VAC 50/60 Hz
2	200 VAC 50/60 Hz
3	110 VAC 50/60 Hz [115 VAC 50/60 Hz]
4	220 VAC 50/60 Hz [230 VAC 50/60 Hz]

* For type W□, only DC voltage is available.
* CE-compliant: For DC only.

Light/Surge voltage suppressor

NII	Without light/surge voltage suppressor
S	With surge voltage suppressor
Z	With light/surge voltage suppressor
R	With surge voltage suppressor (Non-polar type)
U	With light/surge voltage suppressor (Non-polar type)

* For AC voltage valves there is no "S" option. It is already built into the rectifier circuit.

* For "R" and "U", only DC voltage is available.

* Power saving circuit is only available for the "Z" type.

Electrical entry

G	Grommet, 300 mm lead wire
H	Grommet, 600 mm lead wire
L	With lead wire
LN	Without lead wire
LO	Without connector
M	With lead wire
MN	Without lead wire
MO	Without connector
WO	M8 Without connector cable
W□	connector With connector cable ^(Note 1)

* For connector cable of M8 connector, refer to page 646.

Note 1) Enter the cable length symbols in □. Please be sure to fill in the blank referring to page 646.

V115 — 5 D □

Rated voltage

5	24 VDC
6	12 VDC
1	100 VAC 50/60 Hz
2	200 VAC 50/60 Hz
3	110 VAC 50/60 Hz [115 VAC 50/60 Hz]
4	220 VAC 50/60 Hz [230 VAC 50/60 Hz]

* DC specifications of type D and DO are only available with 12 and 24 VDC.

* Power saving circuit is not available for D, Y, DO and YO types.

Light/Surge voltage suppressor

NII	Without light/surge voltage suppressor
S	With surge voltage suppressor (Non-polar type)
Z	With light/surge voltage suppressor (Non-polar type)

* DOZ and YOZ are not available.

* For AC voltage valves there is no "S" option. It is already built into the rectifier circuit.

Electrical entry

D	DIN terminal	With connector
DO	(Type D)	Without connector
Y	DIN terminal	With connector
YO	(Type Y)	Without connector

* Do not replace V111 (G, H, L, M, W) with V115 (DIN terminal) and vice versa when replacing pilot valve assembly only.

Note) Since V111 and V115 are CE-compliant as standard, the suffix "-Q" is not necessary.

Body Ported

* [] for AC

Grommet (G), (H): 10-SYJ7□2M-□^G□□-01□

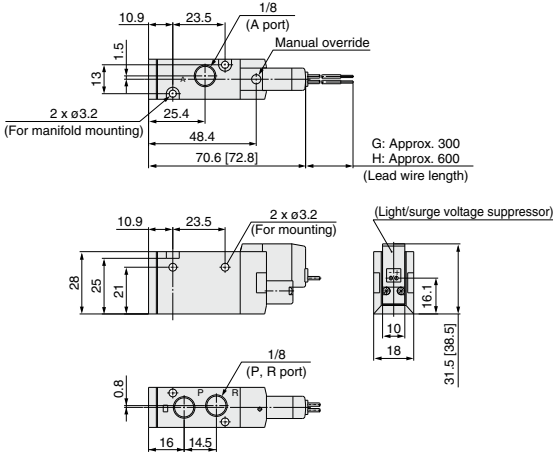

G: Approx. 300
H: Approx. 600
(Lead wire length)

**With bracket:
10-SYJ7□2M-□^G□□-01□-F**

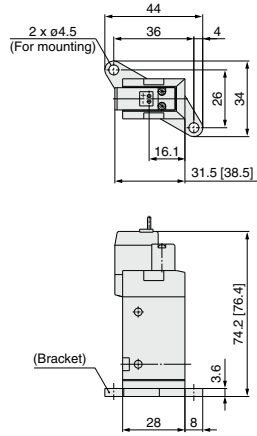

**L plug connector (L):
10-SYJ7□2M-□L□□-01□ (-F)**

**M plug connector (M):
10-SYJ7□2M-□M□□-01□ (-F)**

**DIN terminal (D, Y):
10-SYJ7□2M-□D□□-01□ (-F)**

**M8 connector (WO):
10-SYJ7□2M-□WO□□-01□ (-F)**

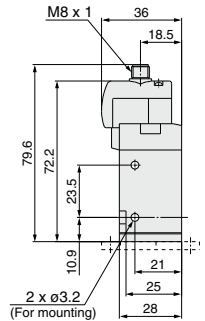
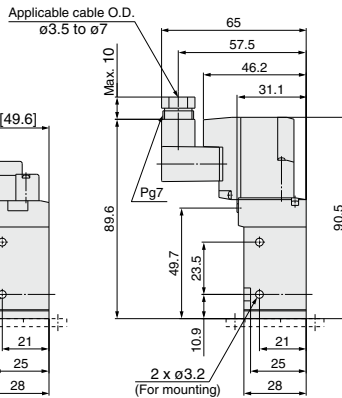
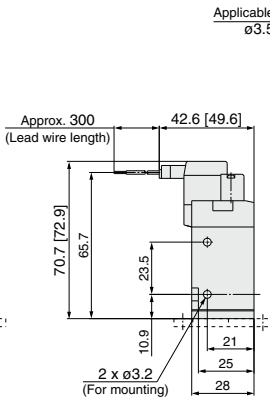
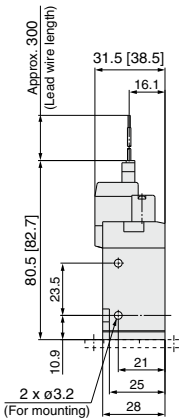

* Refer to page 646 for dimensions with connector cable.

Base Mounted (With Sub-plate)

* [] for AC

Grommet (G), (H): 10-SYJ7□4M-□□□□^G□□□□⁰¹□□⁰²

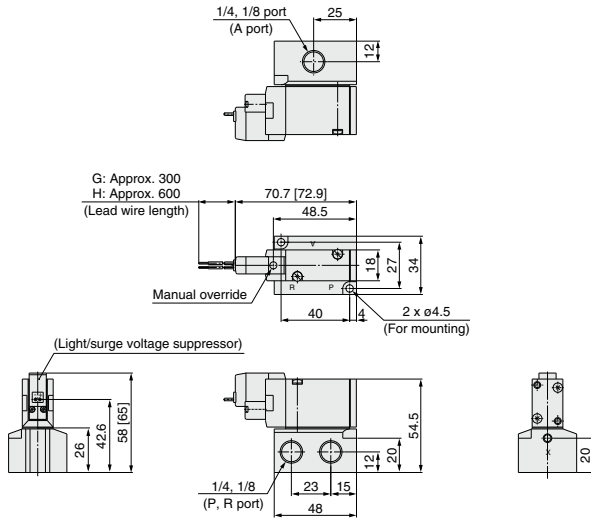

L plug connector (L):
10-SYJ7□4M-□□□□^L□□□□⁰¹□□⁰²

M plug connector (M):
10-SYJ7□4M-□□□□^M□□□□⁰¹□□⁰²

DIN terminal (D, Y):
10-SYJ7□4M-□□□□^D□□□□⁰¹□□⁰²

M8 connector (WO):
10-SYJ7□4M-□□□□^{WO}□□□□⁰¹□□⁰²

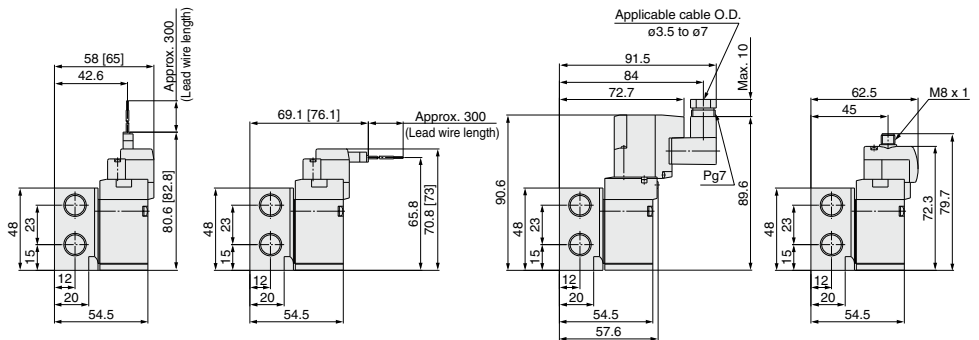

* Refer to page 646 for dimensions with connector cable.

Series 10-SYJ700 Manifold Specifications

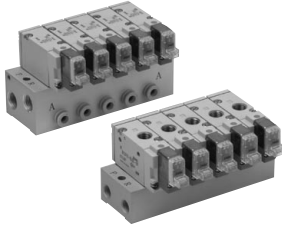

Manifold Specifications

Model	For internal pilot	Type 20	Type 21	Type 40	Type 41	Type 42
Manifold type		Single base/B mount				
P (SUP), R (EXH)		Common SUP, common EXH				
Valve stations		2 to 20 stations				
A port Porting specifications	Location	Valve	Valve	Base	Base	Base
	Direction	Top	Top	Bottom	Bottom	Side
Port size	P, R port	1/8	1/4	1/8	1/4	1/4
	A port	1/8	1/8	1/8	1/8	1/8 C6 (ø8 One-touch fitting) C8 (ø8 One-touch fitting)

Flow Rate Characteristics

Manifold			Port size		Flow rate characteristics					
			1(P), 3(R) port	2(A) port	1→2 (P→A)			2→3 (A→R)		
					C [dm ³ /(sbar)]	b	Cv	C [dm ³ /(sbar)]	b	Cv
Body ported for internal pilot	Type 10-SS3YJ7-20	10-SYJ□2M	1/8	1/8	2.2	0.34	0.55	2.3	0.27	0.59
	Type 10-SS3YJ7-21		1/4	1/8	2.2	0.39	0.59	2.4	0.32	0.62
	Type 10-SS3YJ7-40		1/8	1/8	2.1	0.35	0.59	2.3	0.27	0.54
Base mounted for internal pilot	Type 10-SS3YJ7-41	10-SYJ□4M	1/4	1/8	2.2	0.35	0.59	2.4	0.36	0.66
	Type 10-SS3YJ7-42-01		1/4	1/8	2.0	0.27	0.47	2.2	0.32	0.56
	Type 10-SS3YJ7-42-C6		1/4	C6	1.6	0.32	0.39	2.2	0.27	0.54
	Type 10-SS3YJ7-42-C8		1/4	C8	2.1	0.24	0.51	2.3	0.31	0.59

Note) The values are for individually operated 2 position type manifold bases.

How to Order Manifold (Example)

Instruct by specifying the valves and blanking plate assembly to be mounted on the manifold along with the manifold base model no.

(Example)

10-SS3YJ7-20-03 1 set (manifold base) 10-SS3YJ7-42-03-01 1 set (manifold base)
 * 10-SYJ712M-SLZ-01 2 sets (valve) * 10-SYJ714M-5G 2 sets (valve)
 * SYJ700-10-1A 1 set (blanking plate assembly) * SYJ700-10-2A 1 set (blanking plate assembly)

↳ The asterisk denotes the symbol for assembly. Prefix it to the part no. of the solenoid valve, etc.

Combinations of Solenoid Valve, Manifold Gasket and Manifold Base

Body ported (Type 10-SYJ7□2M(-Q)) Base mounted (Type 10-SYJ7□4M(-Q))

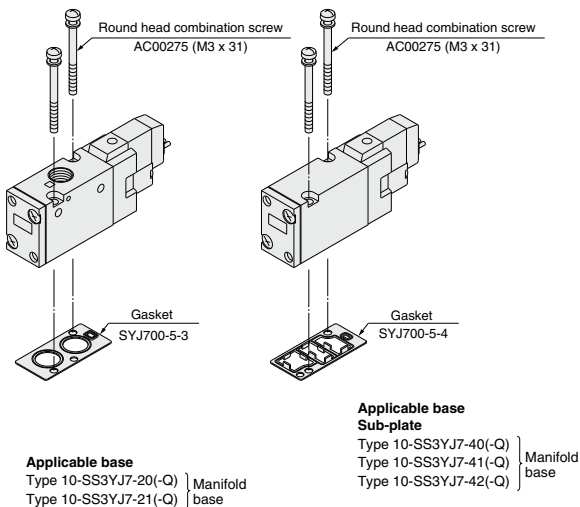

Caution

Mounting screw tightening torque

M3: 0.8 N-m

Use caution to the assembly orientation for solenoid valves, gasket and optional parts.

Blanking Plate Assembly

<Standard>

Part no.: SYJ700-10-1A

- For body ported
- For base mounted

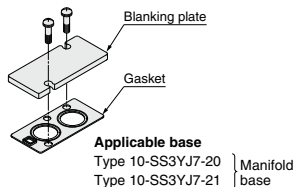

Part no.: SYJ700-10-2A

- For base mounted

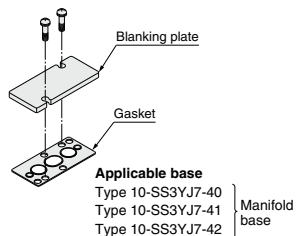

(Note) It can be mounted on a body ported manifold base. However, when mounting a blanking part to a valve, place an order for a separate gasket (SYJ700-5-3) when placing an order for the valve.

When using the SYJ700-10-1A, a gasket for this blanking plate assembly can be used as a gasket for the valve as well.

<CE-compliant>

Part no.: SYJ700-10-2A-1-Q

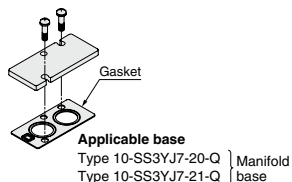

Part no.: SYJ700-10-2A-2-Q

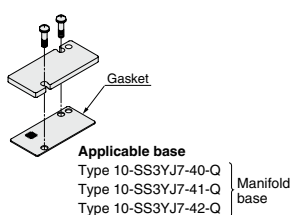

Note) AC-type models that are CE-compliant have DIN terminals only. **CE** [Option]

Manifold for Internal Pilot Type

Type 20/Type 21

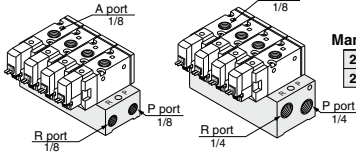

How to Order

10 - SS3YJ7 - 20 - 05 - [] - []

↓ Clean series

Manifold type

20	Type 20
21	Type 21

Stations

02	2 stations
:	:
20	20 stations

P, R port thread type

Nil	Rc
00F	G
00N	NPT
00T	NPTF

CE-compliant

Nil	—
Q	CE-compliant

Applicable solenoid valve
10-SYJ712M-□□□□-01(-Q)
10-SYJ722M-□□□□-01(-Q)

Applicable blanking plate assembly
Refer to page 633.

Note) If there are more than 6 stations for type 20, or more than 9 stations for type 21, supply air to both sides of P port and exhaust air from both sides of R port.

Type 40/Type 41

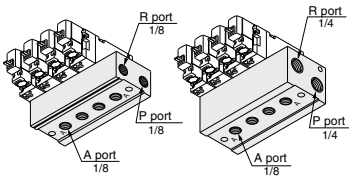

How to Order

10 - SS3YJ7 - 40 - 05 - 01 - [] - []

↓ Clean series

Manifold type

40	Type 40
41	Type 41

Stations

02	2 stations
:	:
20	20 stations

A port size

01	1/8
----	-----

P, R port thread type

Nil	Rc
F	G
N	NPT
T	NPTF

CE-compliant

Nil	—
Q	CE-compliant

Applicable solenoid valve
10-SYJ714M-□□□□(-Q)
10-SYJ724M-□□□□(-Q)

Applicable blanking plate assembly
Refer to page 633.

Note) If there are more than 6 stations for type 40, or more than 9 stations for type 41, supply air to both sides of P port and exhaust air from both sides of R port.

Type 42

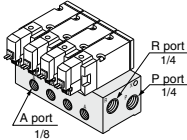

How to Order

10 - SS3YJ7 - 42 - 05 - C6 - [] - []

↓ Clean series

Stations

02	2 stations
:	:
20	20 stations

A port size

01	1/8
C6	e6 One-touch fitting
C8	e8 One-touch fitting
N7	e1/4" One-touch fitting
N9	e5/16" One-touch fitting

P, R port thread type

Nil	Rc
F	G
N	NPT
T	NPTF

CE-compliant

Nil	—
Q	CE-compliant

Applicable solenoid valve
10-SYJ714M-□□□□(-Q)
10-SYJ724M-□□□□(-Q)

Applicable blanking plate assembly
Refer to page 633.

Note) For more than 9 stations, supply air to both sides of P port and exhaust air from both sides of R port.

Directional Control Valves
Air Cylinders
Rotary Actuators
Air Grippers
Air Preparation Equipment
Modular F. R.
Pressure Control Equipment
Fittings & Tubing
Flow Control Equipment
Pressure Switches/ Pressure Sensors

Type 20 Manifold: Top Ported/10-SS3YJ7-20-Stations (-00□)

* [] for AC

Grommet (G)

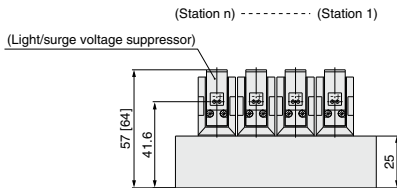
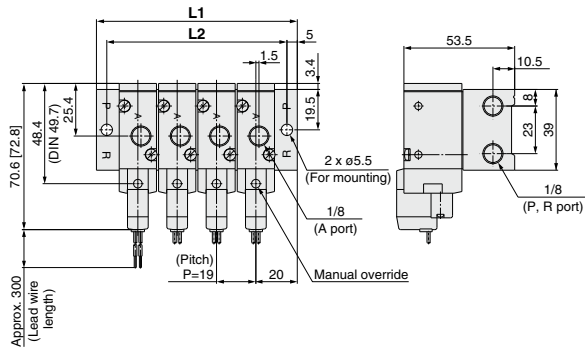

L plug connector (L)

M plug connector (M)

DIN terminal (D, Y)

M8 connector (WO)

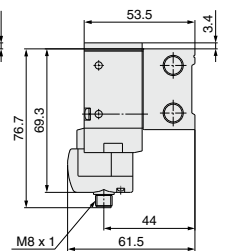
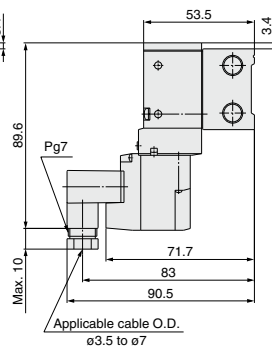
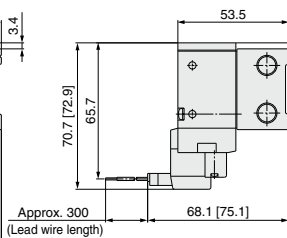
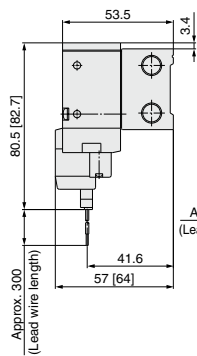

* Refer to page 646 for dimensions with connector cable.

Station	Station 2	3	4	5	6	7	8	9	10	11	12	13	14	15	16	17	18	19	Station 20
L1	59	78	97	116	135	154	173	192	211	230	249	268	287	306	325	344	363	382	401
L2	49	68	87	106	125	144	163	182	201	220	239	258	277	296	315	334	353	372	391

Type 21 Manifold: Top Ported/10-SS3YJ7-21-**Stations** (-00□)

* [] for AC

Grommet (G)

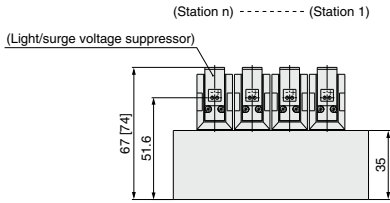
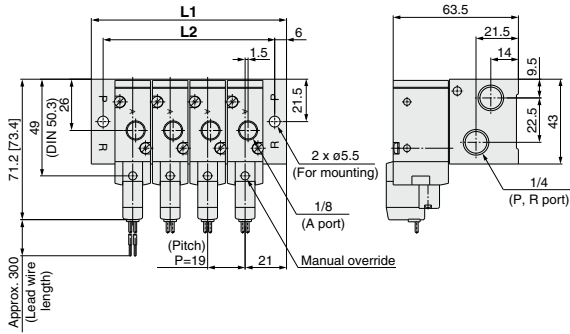

L plug connector (L)

M plug connector (M)

DIN terminal (D, Y)

M8 connector (WO)

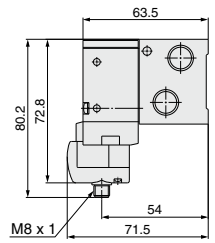
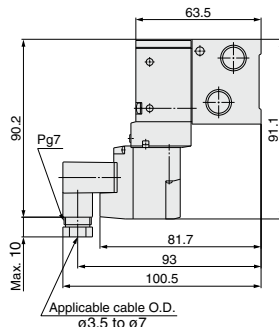
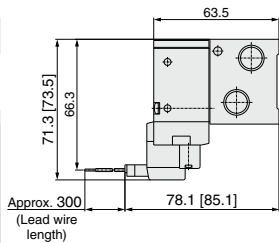
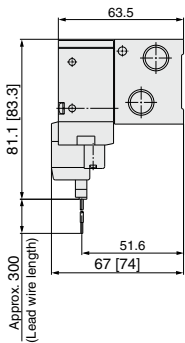

* Refer to page 646 for dimensions with connector cable.

Station	Station 2	3	4	5	6	7	8	9	10	11	12	13	14	15	16	17	18	19	Station 20
L1	61	80	99	118	137	156	175	194	213	232	251	270	289	308	327	346	365	384	403
L2	49	68	87	106	125	144	163	182	201	220	239	258	277	296	315	334	353	372	391

Directional Control Valves

Air Cylinders

Rotary Actuators

Air Grippers

Air Preparation Equipment

Modular F. R.

Pressure Control Equipment

Fittings & Tubing

Flow Control Equipment

Pressure Switches/ Pressure Sensors

Type 40 Manifold: Bottom Ported/10-SS3YJ7-40-Stations-01 □

* [] for AC

Grommet (G)

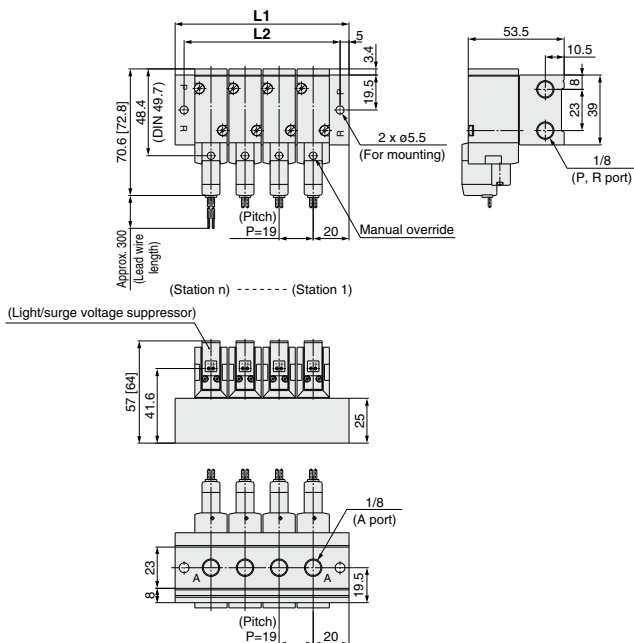

L plug connector (L)

M plug connector (M)

DIN terminal (D, Y)

M8 connector (WO)

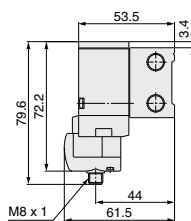
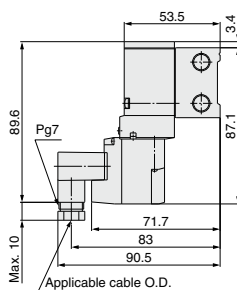
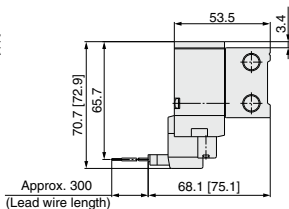
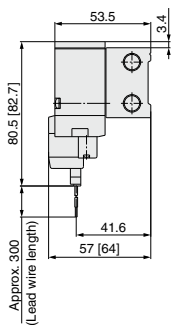

* Refer to page 646 for dimensions with connector cable.

Station	Station 2	3	4	5	6	7	8	9	10	11	12	13	14	15	16	17	18	19	Station 20
L1	59	78	97	116	135	154	173	192	211	230	249	268	287	306	325	344	363	382	401
L2	49	68	87	106	125	144	163	182	201	220	239	258	277	296	315	334	353	372	391

Type 42 Manifold: Side Ported/10-SS3YJ7-42-Stations-01, C6, N7, C8, N9

* [] for AC

Grommet (G)

For C6, N7, C8, N9 (Built-in One-touch fitting)

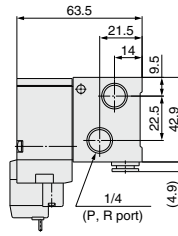
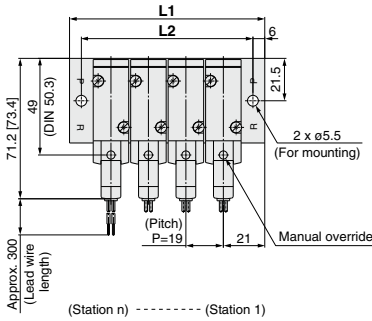

For 1/8

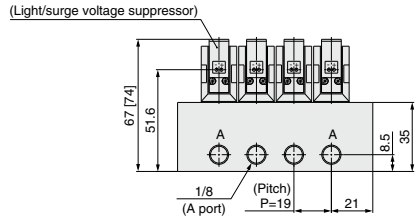
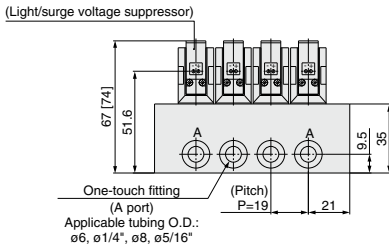

L plug connector (L)

M plug connector (M)

DIN terminal (D, Y)

M8 connector (W0)

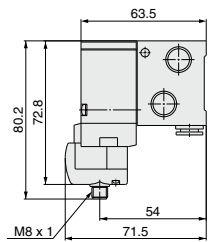
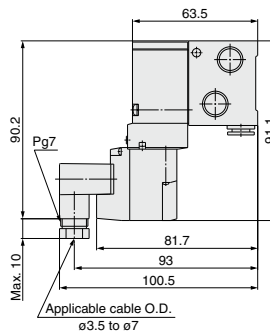
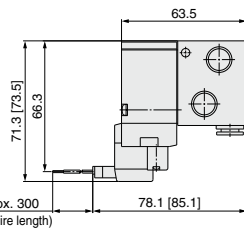
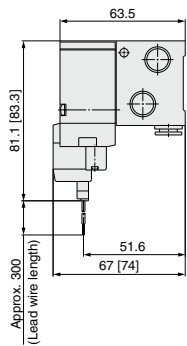

* Refer to page 646 for dimensions with connector cable.

Station	Station 2	3	4	5	6	7	8	9	10	11	12	13	14	15	16	17	18	19	Station 20
L1	61	80	99	118	137	156	175	194	213	232	251	270	289	308	327	346	365	384	403
L2	49	68	87	106	125	144	163	182	201	220	239	258	277	296	315	334	353	372	391

Directional Control Valves
 Air Cylinders
 Rotary Actuators
 Air Grippers
 Air Preparation Equipment
 Modular F. R.
 Pressure Control Equipment
 Fittings & Tubing
 Flow Control Equipment
 Pressure Switches/ Pressure Sensors

Type 41 Manifold: Bottom Ported/10-SS3YJ7-41-Stations-01 □

* [] for AC

Grommet (G)

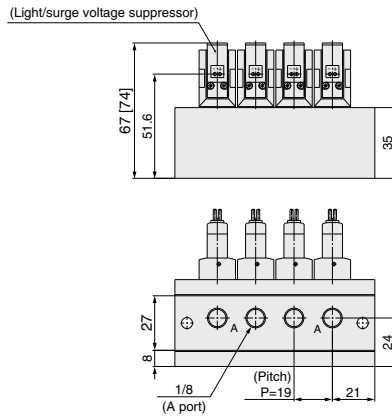

* Other dimensions are the same as type 42.
For dimensions, refer to page 638.

M8 Connector Conforming to IEC60947-5-2

Series 10-SYJ300/500/700

Made to Order



How to Order Valve

Actuation type

1	Normally closed
2	Normally open

Series

3	10-SYJ300
5	10-SYJ500
7	10-SYJ700

Rated voltage

DC	
5	24 VDC
6	12 VDC
V	6 VDC
S	5 VDC
R	3 VDC

Light/Surge voltage suppressor

Nil	Without light/surge voltage suppressor
S	With surge voltage suppressor
Z	With light/surge voltage suppressor
R	With surge voltage suppressor (Non-polar type)
U	With light/surge voltage suppressor (Non-polar type)

Port size

M3	M3 x 0.5 (10-SYJ300 only)
M5	M5 x 0.8 (10-SYJ500 only)
01	1/8 (10-SYJ700 only)

Bracket

Nil	Without bracket
F	With bracket

Body option

M	Main/Pilot valve common exhaust type
---	--------------------------------------

Electrical entry

WAO: Without connector cable

WA□: With connector cable^{Note}

CE-compliant

Nil	—
Q	CE-compliant

Thread type

Nil	Rc
F	G
N	NPT
T	NPTF

Port size

Nil	Without sub-plate	
M5	M5 port	10-SYJ300
	With sub-plate	
01	1/8 port	10-SYJ500
	With sub-plate	10-SYJ700
02	1/4 port	10-SYJ700
	With sub-plate	

Manual override

Nil	Non-locking push type
D	Push-turn locking slotted type
E	Push-turn locking lever type

Body ported

Base mounted

3 port (Sub-plate type, type 40, 41, S41, 42, S42 manifold)

3 port (Type 20, 21 manifold)

Clean series

Ordering Example:

Body ported: 10-SYJ 5 1 2 M - 5 WAO □ □ □ - M5 - □ - □

Base mounted: 10-SYJ 5 1 4 M - 5 WAO □ □ □ - 01 □ - □

Note: Enter the cable length symbols in □. Please be sure to fill in the blank referring to page 646.

How to Order Pilot Valve Assembly

V111- 5 WAO □ □

Rated voltage

DC	
5	24 VDC
6	12 VDC
V	6 VDC
S	5 VDC
R	3 VDC

Light/Surge voltage suppressor

Nil	Without light/surge voltage suppressor
S	With surge voltage suppressor
Z	With light/surge voltage suppressor
R	With surge voltage suppressor (Non-polar type)
U	With light/surge voltage suppressor (Non-polar type)

Electrical entry

WAO	M8 connector	Without connector cable
WA□		With connector cable ^{Note}

Note: Enter the cable length symbols in □. Please be sure to fill in the blank referring to page 646.

Note) Since V111 is CE-compliant as standard, the suffix "Q" is not necessary.

Directional Control Valves

Air Cylinders

Rotary Actuators

Air Grippers

Air Preparation Equipment

Modular F. R.

Pressure Control Equipment

Fittings & Tubing

Flow Control Equipment

Pressure Switches/Pressure Sensors



Series 10-SYJ300/500/700 Specific Product Precautions 1

Be sure to read this before handling.

Refer to page 1382 for Safety Instructions and pages 677 to 683 for 3/4/5 Port Solenoid Valve Precautions.

Manual Override Operation

Warning

When the manual override is operated, connected equipment will be actuated. Confirm safety before operating.

■ Non-locking push type [Standard]

Press in the direction of the arrow.



■ Push-turn slotted locking type [Type D]

While pressing the lock down, turn it in the direction of the arrow. If it does not turn, it can be operated the same way as the non-locking type.



Locked position



Caution

When operating the locking type D with a screw driver, turn it gently using a watchmakers screw driver. [Torque: Less than 0.1 N·m]

■ Push-turn locking lever type [Type E]

While pressing the lever down, turn it in the direction of the arrow. If it does not turn, it can be operated the same way as the non-locking type.



Locked position

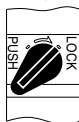

Caution

When locking the manual override on the push-turn locking types (D, E), be sure to push the lock down before turning it. Turning without first pushing it down can cause damage to the manual override and trouble such as air leakage, etc.

Solenoid Valve for 200, 220 VAC Specifications

Warning

Solenoid valves with grommet and L/M type plug connector AC specifications have a built-in rectifier circuit in the pilot section to operate the DC coil.

With 200, 220 VAC specification pilot valves, this built-in rectifier generates heat when energized. The surface may become hot depending on the energization state; therefore, do not touch the solenoid valves.

Main/Pilot Valve Common Exhaust Type

Caution

Pilot air is exhausted through the main valve body rather than directly to atmosphere.

- Suitable for applications where exhausting the pilot valve to atmosphere would be detrimental to the surrounding working environment.
- For use in extremely dirty environments where there is the possibility that dust could enter the pilot exhaust and damage the valve.

Ensure that the piping of exhaust air is not too restrictive.

Bracket

Caution

For bracket attached type of the 10-SYJ300 series, do not use it without bracket.



Series 10-SYJ300/500/700 Specific Product Precautions 2

Be sure to read this before handling.
Refer to page 1382 for Safety Instructions and pages 677 to 683 for 3/4/5 Port Solenoid Valve Precautions.

How to Use Plug Connector

⚠ Caution

1. Attaching and detaching connectors

- To attach a connector, hold the lever and connector unit between your fingers and insert straight onto the pins of the solenoid valve so that the lever's pawl is pushed into the groove and locks.
- To detach a connector, remove the pawl from the groove by pushing the lever downward with your thumb, and pull the connector straight out.

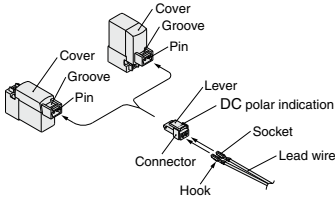

2. Crimping connection of lead wire and socket

Strip 3.2 to 3.7 mm at the end of the lead wires, insert the end of the core wires evenly into the sockets, and then crimp it with a crimping tool. When this is done, take care that the coverings of the lead wires do not enter the core wire crimping area.

Use an exclusive crimping tool for crimping.
(Please contact SMC for the dedicated crimping tools.)

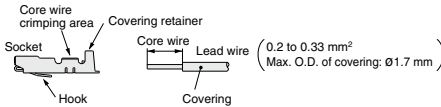

3. Attaching and detaching sockets with lead wires

• Attaching

Insert the sockets into the square holes of the connector (+, - indication), and continue to push the sockets all the way in until they lock by hooking into the seats in the connector. (When they are pushed in, the hooks open and they are locked automatically.) Then confirm that they are locked by pulling lightly on the lead wires.

• Detaching

To detach a socket from a connector, pull out the lead wire while pressing the socket's hook with a thin tipped stick (approx. 1 mm). If the socket is to be used again, first spread the hook outward.

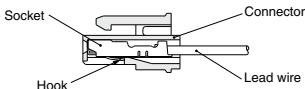

Plug Connector Lead Wire Length

⚠ Caution

Standard length is 300 mm, but the following lengths are also available.

How to Order Connector Assembly

For DC: **SY100-30-4A**

For 100 VAC: **SY100-30-1A**

For 200 VAC: **SY100-30-2A**

For other voltages of AC: **SY100-30-3A**

Without lead wire: **SY100-30-A**
(with connector and 2 of sockets only)

• Lead wire length

Nil	300 mm
6	600 mm
10	1000 mm
15	1500 mm
20	2000 mm
25	2500 mm
30	3000 mm
50	5000 mm

How to Order

Include the connector assembly part number together with the part number for the plug connector's solenoid valve without connector.

Example) Lead wire length 2000 mm

For DC

10-SYJ312-5LO-M3
SY100-30-4A-20

For AC

10-SYJ312-1LO-M3
SY100-30-1A-20

Directional Control Valves

Air Cylinders

Rotary Actuators

Air Grippers

Air Preparation Equipment

Modular F. R.

Pressure Control Equipment

Fittings & Tubing

Flow Control Equipment

Pressure Switches/ Pressure Sensors



Series 10-SYJ300/500/700 Specific Product Precautions 3

Be sure to read this before handling.
Refer to page 1382 for Safety Instructions and pages 677 to 683 for 3/4/5 Port Solenoid Valve Precautions.

Surge Voltage Suppressor

Caution

<For DC>
Grommet, L/M Plug Connector



■ Polar type (Standard)

With surge voltage suppressor (□S)

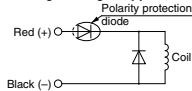

With light/surge voltage suppressor (□Z)

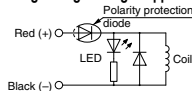

■ Non-polar type

With surge voltage suppressor (□R)

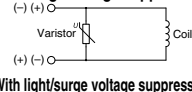

With light/surge voltage suppressor (□U)

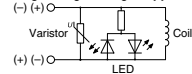

- Connect the polar type in accordance with the +, - polarity indication. (The non-polar type can be used with the connections made either way.)
- Since voltage specifications other than polar type 24 and 12 VDC do not have diodes for polarity protection, be careful not to make errors in the polarity.
- When wiring is done at the factory, positive (+) is red and negative (-) is black.

■ With power saving circuit

Power consumption is decreased by 1/4 by reducing the wattage required to hold the valve in an energized state. (Effective energizing time is over 62 ms at 24 VDC.)

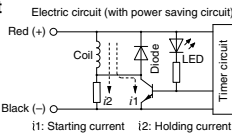

Operating Principle

With the above circuit, the current consumption when holding is reduced to save energy. Please refer to the electric wave data to the right.

- Please be careful not to reverse the polarity, since a diode to prevent the reversed current is not provided for the power saving circuit.

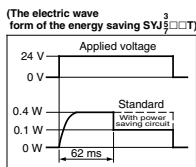

DIN Terminal

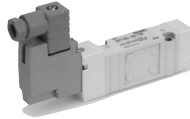

With surge voltage suppressor (DS)

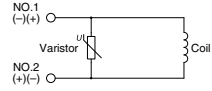

With light/surge voltage suppressor (DZ)

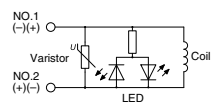

DIN terminal has no polarity.

M8 Connector

■ Polar type (Standard)

With surge voltage suppressor (□S)

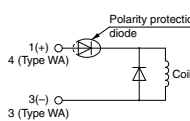

With light/surge voltage suppressor (□Z)

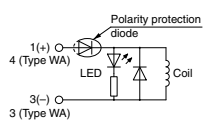

■ Non-polar type

With surge voltage suppressor (□R)

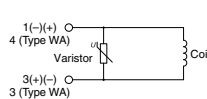

With light/surge voltage suppressor (□U)

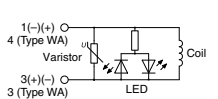

Solenoid valve side pin wiring diagram

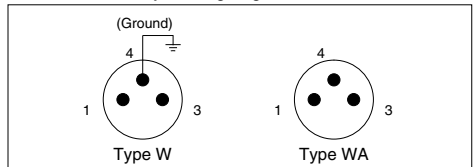

- For wiring of the polar type, connect + to 1 and - to 3 for type W, and + to 4 and - to 3 for type WA.
- Please be careful not to reverse the polarity, since a diode to prevent the reversed current is not provided for DC voltages other than 24 and 12 VDC.
- The WA-type valve cannot be grounded.



Series 10-SYJ300/500/700 Specific Product Precautions 4

Be sure to read this before handling.
Refer to page 1382 for Safety Instructions and pages 677 to 683 for 3/4/5 Port Solenoid Valve Precautions.

Surge Voltage Suppressor

<For AC>

(There is no "S" option, because the generation of surge voltage is prevented by a rectifier.)

⚠ Caution

Grommet, L/M Plug Connector

With light (□Z)

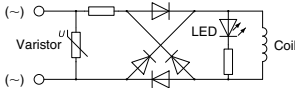

DIN Terminal

With light (DZ)

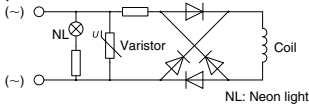

NL: Neon light

Note) The surge voltage suppressor of the varistor has residual voltage corresponding to the protective element and rated voltage. Therefore, protect the controller side from the surge voltage. The residual voltage of the diode is approximately 1 V.

How to Use DIN Terminal

⚠ Caution Connection

- Loosen the holding screw and pull the connector out of the solenoid valve terminal block.
- After removing the holding screw, insert a flat head screwdriver, etc. into the notch on the bottom of the terminal block and pry it open, separating the terminal block and the housing.
- Loosen the terminal screws (slotted screws) on the terminal block, insert the cores of the lead wires into the terminals according to the connection method, and fasten them securely with the terminal screws.
- Secure the cord by fastening the gland nut.

⚠ Caution

When making connections, take note that using other than the supported size (ø3.5 to ø7) heavy duty cord will not satisfy IP65 (enclosure) standards. Also, be sure to tighten the gland nut and holding screw within their specified torque ranges.

Changing the entry direction

After separating the terminal block and housing, the cord entry can be changed by attaching the housing in the desired direction (4 directions at 90° intervals).

* When equipped with a light, be careful not to damage the light with the cord's lead wires.

Precautions

Plug in and pull out the connector vertically without tilting to one side.

How to Use DIN Terminal

⚠ Caution

Compatible cable

Cord O.D.: ø3.5 to ø7

(Reference) 0.5mm², 2-core or 3-core, equivalent to JIS C 3306

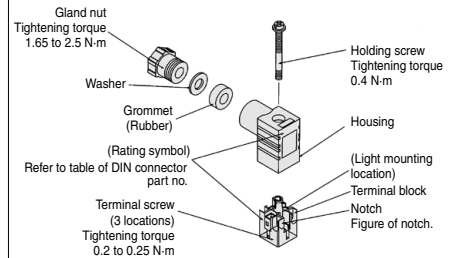

Type "Y"

DIN connector type Y is a DIN connector that conforms to the DIN pitch 8-mm standard.

- D type DIN connector with 9.4 mm pitch between terminals is not interchangeable.
- To distinguish from the D type DIN connector, "N" is listed at the end of voltage symbol. (For connector parts without lights, "N" is not indicated. Please refer to the name plate to distinguish.)
- Dimensions are completely the same as D type DIN connector.
- When exchanging the pilot valve assembly only, "V115-□D" is interchangeable with "V115-□Y". Do not replace V111 (G, L, M) to V115-□D/□Y (DIN terminal), and vice versa.

Solenoid Valve Mounting

⚠ Caution

Mount so that there is no slippage or deformation in gaskets, and tighten with the tightening torque as shown below.

Model	Thread size	Tightening torque
10-SYJ300	M1.7	0.12 N-m
10-SYJ500	M2.5	0.45 N-m
10-SYJ700	M3	0.8 N-m

Directional Control Valves

Air Cylinders

Rotary Actuators

Air Grippers

Air Preparation Equipment

Modular F. R.

Pressure Control Equipment

Fittings & Tubing

Flow Control Equipment

Pressure Switches/Pressure Sensors



Series 10-SYJ300/500/700 Specific Product Precautions 5

Be sure to read this before handling.

Refer to page 1382 for Safety Instructions and pages 677 to 683 for 3/4/5 Port Solenoid Valve Precautions.

DIN Connector Part No.

⚠ Caution

<Type D>

Without light	SY100-61-1
---------------	------------

With light

Rated voltage	Voltage symbol	Part no.
24 VDC	24 V	SY100-61-3-05
12 VDC	12 V	SY100-61-3-06
100 VAC	100 V	SY100-61-2-01
200 VAC	200 V	SY100-61-2-02
110 VAC	110 V	SY100-61-2-03
220 VAC	220 V	SY100-61-2-04

<Type Y>

Without light	SY100-82-1
---------------	------------

With light

Rated voltage	Voltage symbol	Part no.
24 VDC	24 VN	SY100-82-3-05
12 VDC	12 VN	SY100-82-3-06
100 VAC	100 VN	SY100-82-2-01
200 VAC	200 VN	SY100-82-2-02
110 VAC (115 VAC)	110 VN	SY100-82-2-03
220 VAC (230 VAC)	220 VN	SY100-82-2-04

Circuit Diagram with Light

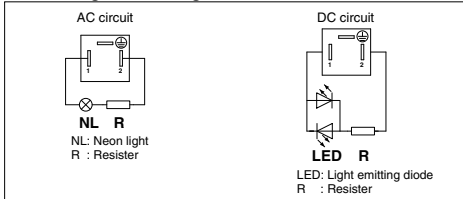

Connector Assembly with Cover

⚠ Caution

Connector assembly with dust proof protective cover.

- Effective to prevention of short circuit failure due to the entry of foreign matter into the connector.
- Chloroprene rubber for electrical use, which provides outstanding weather resistance and electrical insulation, is used for the cover material. However, do not allow contact with cutting oil, etc.
- Simple and unencumbered appearance by adopting round-shaped cord.

How to Order

SY100-68-A-□

Lead wire length

Nil	300 mm
6	600 mm
10	1000 mm
15	1500 mm
20	2000 mm
25	2500 mm
30	3000 mm
50	5000 mm

Connector Assembly with Cover: Dimensions

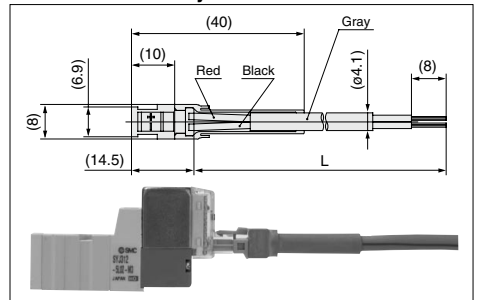

How to Order

Enter the part number for a plug connector solenoid valve without connector together with the part number for a connector assembly with cover.

Example 1) Lead wire length of 2000 mm
10-SYJ312-5LOZ-M3
SY100-68-A-20

Example 2) Lead wire length of 300 mm (standard)
10-SYJ312-5LPZ-M3

□ Symbol for connector assembly with cover

* In this case, the part number for the connector assembly with cover is not required.



Series 10-SYJ300/500/700 Specific Product Precautions 6

Be sure to read this before handling.
Refer to page 1382 for Safety Instructions and pages 677 to 683 for 3/4/5 Port Solenoid Valve Precautions.

M8 Connector

⚠ Caution

- M8 connectors have an IP65 (enclosure) rating, offering protection from dust and water. However please note that these products are not intended for use in water. Select a SMC connector cable (V100-49-1-□) or a FA sensor type connector, with M8 threaded 3 pin specifications conforming to Nippon Electric Control Equipment Industries Association Standard, NECA4202 (IEC60947-5-2). Make sure the connector O.D. is 10.5 mm or less when used with the 10-SYJ300 series manifold. If more than 10.5 mm, it cannot be mounted due to the size.
- Do not use a tool to mount the connector, as this may cause damage. Only tighten by hand. (0.4 to 0.6 N·m)
- Excessive stress on the cable connector will cause a loss of the IP65 rating. Please use caution and do not apply a stress of 30 N or greater.

⚠ Caution

Failure to meet IP65 performance may result if using alternative connectors than those shown above, or when insufficiently tightened.

• Connector cable mounting

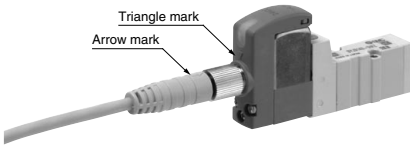

Note) Connector cable should be mounted in the correct direction. Make sure that the arrow symbol on the connector is facing the triangle symbol on the valve when using a SMC connector cable (V100-49-1-□). Be careful not to squeeze it in the wrong direction, as problems such as pin damage may occur.

■ Connector cable

- Connector cable for M8 can be ordered as follows:

How to Order

- To order a solenoid valve and connector cable at the same time.

(Connector cable will be included in the shipment of the solenoid valve.)

10-SYJ $\frac{3}{5/7}$ □ □ □ - □ □ □ □ - □ □ □

Electrical entry

- W1, WA1: Cable length 300 mm
- W2, WA2: Cable length 500 mm
- W3, WA3: Cable length 1000 mm
- W4, WA4: Cable length 2000 mm
- W7, WA7: Cable length 5000 mm

Example 1) Cable length: 300 mm
10-SYJ312-5W1ZE-M3

↳ Symbol for electrical entry

2. To order connector cable only

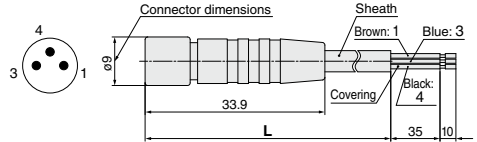

Cable length (L)	Part no.
300 mm	V100-49-1-1
500 mm	V100-49-1-2
1000 mm	V100-49-1-3
2000 mm	V100-49-1-4
5000 mm	V100-49-1-7

Sheath O.D.	ø3.4 mm
Cover diameter	ø1.16 mm
Conductor area	0.16 mm ²

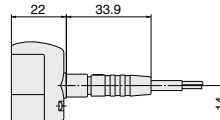

Directional Control Valves

Air Cylinders

Rotary Actuators

Air Grippers

Air Preparation Equipment

Modular F. R.

Pressure Control Equipment

Fittings & Tubing

Flow Control Equipment

Pressure Switches/ Pressure Sensors



Series 10-SYJ300/500/700 Specific Product Precautions 7

Be sure to read this before handling.

Refer to page 1382 for Safety Instructions and pages 677 to 683 for 3/4/5 Port Solenoid Valve Precautions.

Replacement of Pilot Valve

Caution

Pilot valves in this series are improved to provide excellent energy saving results. However following this improvement, these new valves are no longer compatible with the existing pilot valve used at the interface. Consult with SMC if you need to exchange these pilot valves, for manual override (marked in orange) of the adapter plate.

New valve

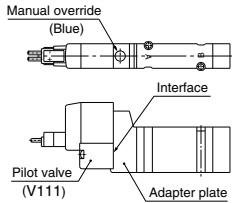

Existing valve

