

Compatible controllers

JXC

Actuator Cable 1

[Robotic cable for battery-less absolute (Step motor 24 VDC)]

LE-CE-1

Cable length (L) [m]

1	1.5
3	3
5	5
8	8*1
A	10*1
B	15*1
C	20*1

*1 Produced upon receipt of order

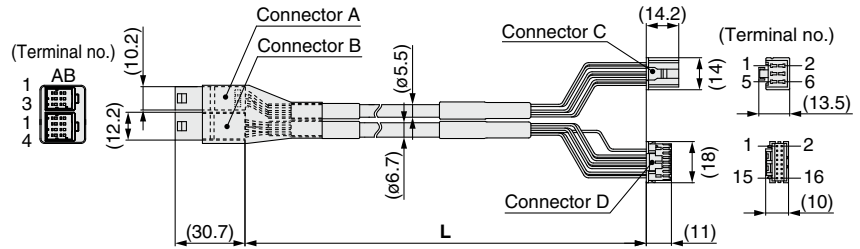

Weight

Product no.	Weight [g]	Note
LE-CE-1	190	Robotic cable
LE-CE-3	360	
LE-CE-5	570	
LE-CE-8	900	
LE-CE-A	1120	
LE-CE-B	1680	
LE-CE-C	2210	

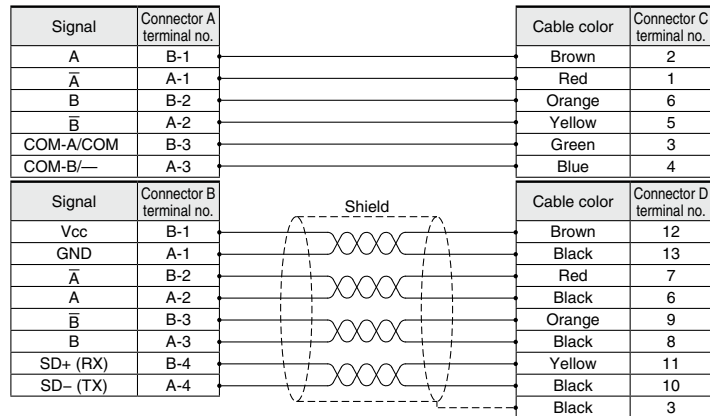

[Robotic cable with lock for battery-less absolute (Step motor 24 VDC)]

LE-CE-1-B

Cable length (L) [m]

1	1.5
3	3
5	5
8	8*1
A	10*1
B	15*1
C	20*1

*1 Produced upon receipt of order

With lock and sensor

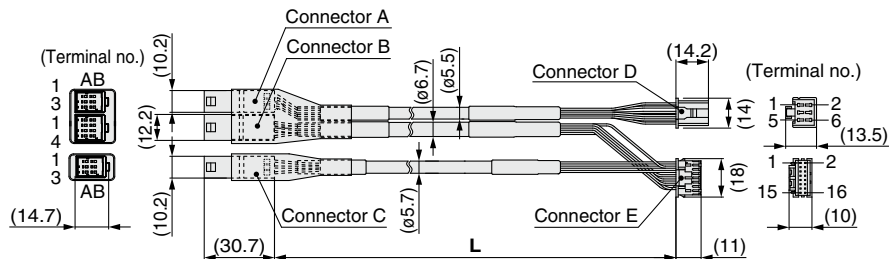

Weight

Product no.	Weight [g]	Note
LE-CE-1-B	240	Robotic cable
LE-CE-3-B	460	
LE-CE-5-B	740	
LE-CE-8-B	1170	
LE-CE-A-B	1460	
LE-CE-B-B	2120	
LE-CE-C-B	2890	

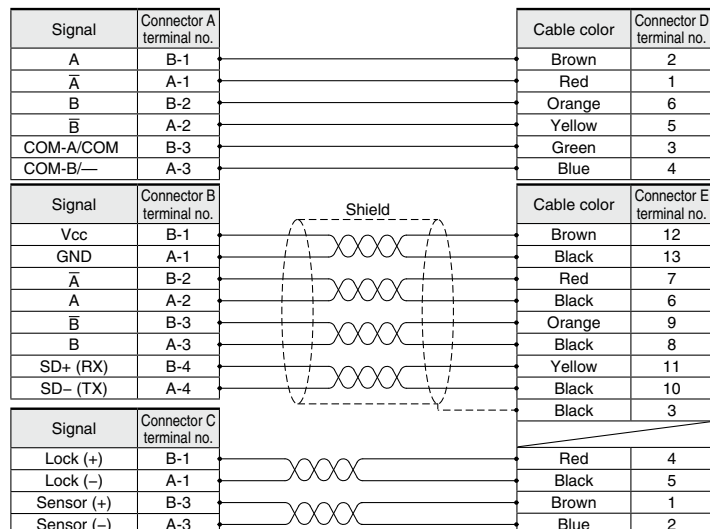

Compatible controllers

JXC LECP1
LECP2 LECPA

Actuator Cable 2

[Robotic cable, standard cable for incremental (Step motor 24 VDC)]

LE-CP-1-□

Cable length (L) [m]

1	1.5
3	3
5	5
8	8*1
A	10*1
B	15*1
C	20*1

*1 Produced upon receipt of order (Robotic cable only)

Cable type

Nil	Robotic cable (Flexible cable)
S	Standard cable

Weight

Product no.	Weight [g]	Note
LE-CP-1-S	190	Standard cable
LE-CP-3-S	280	
LE-CP-5-S	460	
LE-CP-1	140	Robotic cable
LE-CP-3	260	
LE-CP-5	420	
LE-CP-8	790	
LE-CP-A	980	
LE-CP-B	1460	
LE-CP-C	1940	

LE-CP-¹/₅/Cable length: 1.5 m, 3 m, 5 m

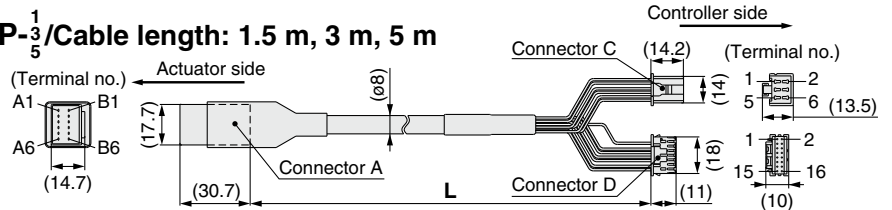

LE-CP-^{8 B}/_{AC}/Cable length: 8 m, 10 m, 15 m, 20 m
(*1 Produced upon receipt of order)

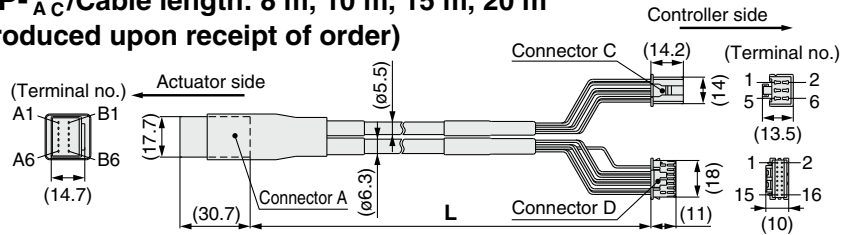

Signal	Connector A terminal no.	Cable color	Connector C terminal no.
A	B-1	Brown	2
A	A-1	Red	1
B	B-2	Orange	6
B	A-2	Yellow	5
COM-A/COM	B-3	Green	3
COM-B/-	A-3	Blue	4
Shield			
Vcc	B-4	Brown	12
GND	A-4	Black	13
A	B-5	Red	7
A	A-5	Black	6
B	B-6	Orange	9
B	A-6	Black	8
			3

[Robotic cable, standard cable with lock and sensor for incremental (Step motor 24 VDC)]

LE-CP-1-B-□

Cable length (L) [m]

1	1.5
3	3
5	5
8	8*1
A	10*1
B	15*1
C	20*1

*1 Produced upon receipt of order (Robotic cable only)

With lock and sensor

Cable type

Nil	Robotic cable (Flexible cable)
S	Standard cable

Weight

Product no.	Weight [g]	Note
LE-CP-1-B-S	240	Standard cable
LE-CP-3-B-S	380	
LE-CP-5-B-S	630	
LE-CP-1-B	190	Robotic cable
LE-CP-3-B	360	
LE-CP-5-B	590	
LE-CP-8-B	1060	
LE-CP-A-B	1320	
LE-CP-B-B	1920	
LE-CP-C-B	2620	

LE-CP-¹/₅/Cable length: 1.5 m, 3 m, 5 m

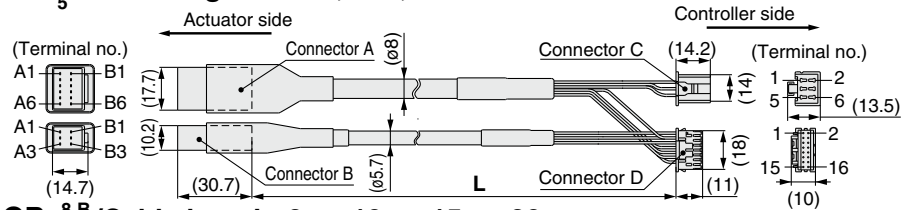

LE-CP-^{8 B}/_{AC}/Cable length: 8 m, 10 m, 15 m, 20 m
(*1 Produced upon receipt of order)

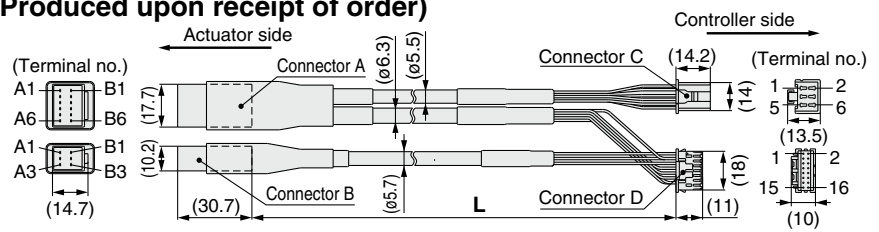

Signal	Connector A terminal no.	Cable color	Connector C terminal no.
A	B-1	Brown	2
A	A-1	Red	1
B	B-2	Orange	6
B	A-2	Yellow	5
COM-A/COM	B-3	Green	3
COM-B/-	A-3	Blue	4
Shield			
Vcc	B-4	Brown	12
GND	A-4	Black	13
A	B-5	Red	7
A	A-5	Black	6
B	B-6	Orange	9
B	A-6	Black	8
			3
Signal	Connector B terminal no.	Cable color	Connector D terminal no.
Lock (+)	B-1	Red	4
Lock (-)	A-1	Black	5
Sensor (+)	B-3	Brown	1
Sensor (-)	A-3	Blue	2

Compatible controller

LECA6

Actuator Cable 3

[Robotic cable for incremental (Servo motor 24 VDC)]

LE-CA-1

Cable length (L) [m]

1	1.5
3	3
5	5
8	8*1
A	10*1
B	15*1
C	20*1

*1 Produced upon receipt of order

Weight

Product no.	Weight [g]
LE-CA-1	220
LE-CA-3	420
LE-CA-5	700
LE-CA-8	1100
LE-CA-A	1370
LE-CA-B	2050
LE-CA-C	2720

LE-CA-□

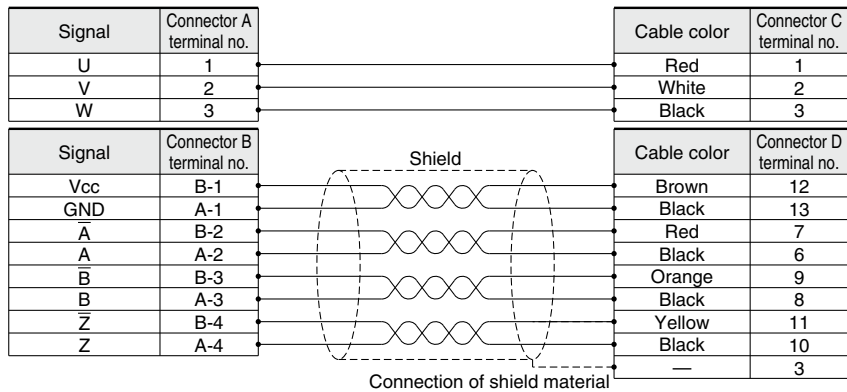
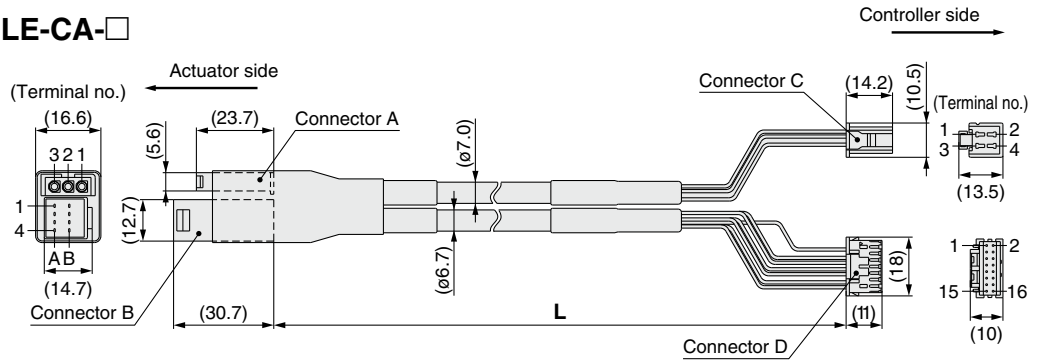

[Robotic cable with lock and sensor for incremental (Servo motor 24 VDC)]

LE-CA-1-B

Cable length (L) [m]

1	1.5
3	3
5	5
8	8*1
A	10*1
B	15*1
C	20*1

*1 Produced upon receipt of order

With lock and sensor

LE-CA-□-B

