

# Electric Actuator

## High Performance Slider Type

New



— For details, refer to page 57 and onward. —

Battery-less Absolute (Step Motor 24 VDC)



# Reduces cycle time

Cycle time

Reduced by **39%** (0.57 s ← 0.93 s)  
compared with the existing model\*<sup>1</sup>

\*1 When LEFS25GH-400 is operated from 0 to 400 mm

Acceleration/  
Deceleration

**10000 mm/s<sup>2</sup>**  
(334% increase compared with the existing model)

Max. speed

**1500 mm/s**  
(Improved by 25% compared with the existing model)

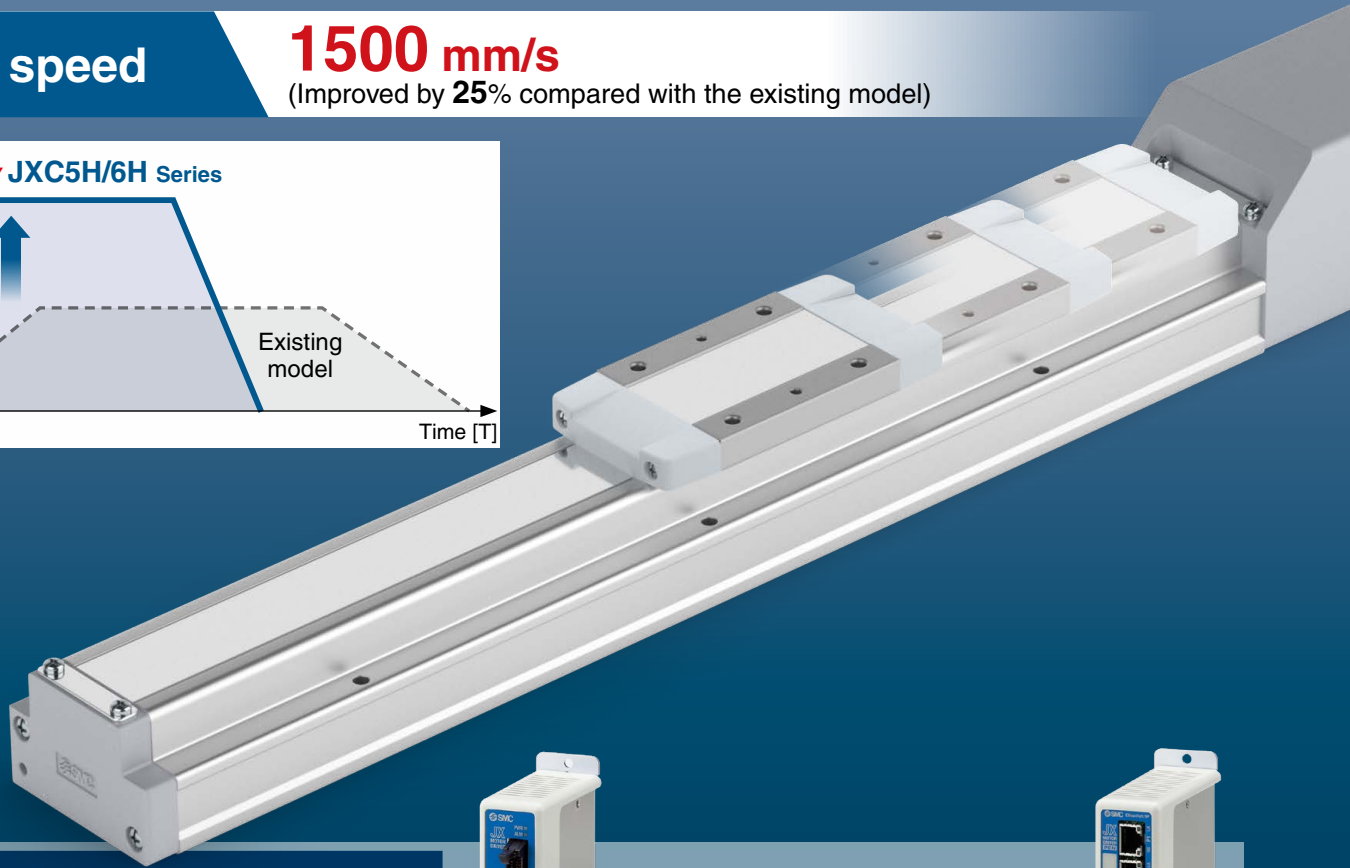
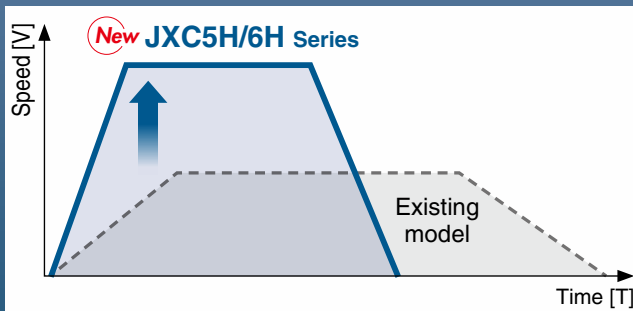

High Performance  
Step Motor Controller

Higher acceleration and maximum speed can be set with the special controller (for LEFS□G Series).

Parallel I/O

JXC5H/6H Series p. 43



EtherCAT/EtherNet/IP™/  
PROFINET

JXCEH/9H/PH Series p. 50



LEFS□G Series



CAT.ES100-148A

# Battery-less absolute encoder compatible

## Easy operation restart after recovery of the power supply

The battery-less absolute encoder mounted on the motor retains position information at all times, regardless of whether the control power supply is ON or OFF. A return to origin operation is not necessary when the power supply is recovered.

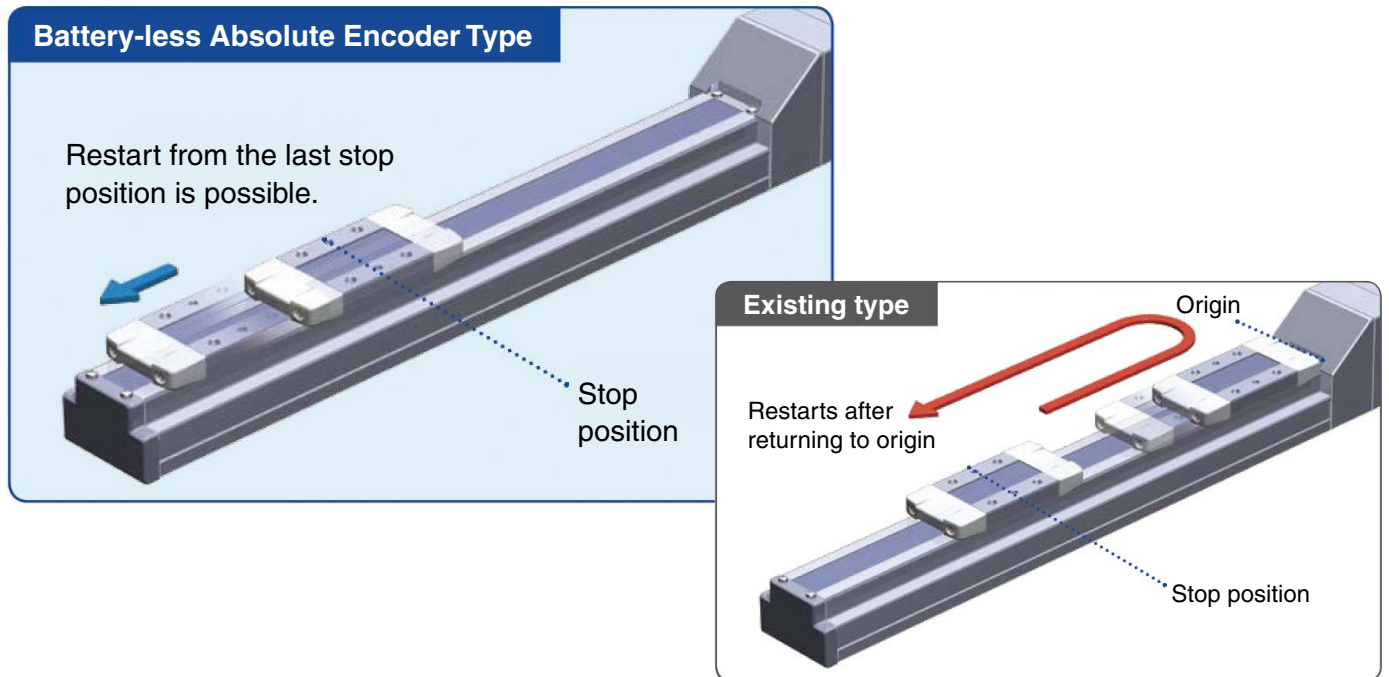

## Maintenance labor can be reduced as the product does not require the use of batteries.

Batteries are not required to store the position information. Therefore, there is no need to store spare batteries or to recycle and replace dead batteries.



Step Data Input Type **JXC5H/6H Series** p. 43



# Simple setting allows for immediate use!

## “Easy Mode” for simple setting

For immediate use, select “Easy Mode.”

Step motor  
(Servo/24 VDC)

**JXC5H/6H**

### <When a PC is used> Controller setting software

- Step data setting, test drive, jogging, and move for the constant rate can be set and operated on one screen.

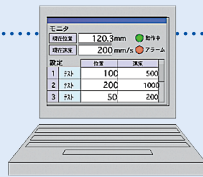

The screenshot shows the 'Easy Mode' window with the following elements:

- Buttons:** Test Mode, RTN ORG, Stop, Servo ON, Get Pos, Jog Speed, Test DRV.
- Status:** ALARM, SVRE, BUSY, INP, SETON.
- Step Data Table:**

No.	Move M	Speed	Position	PushInF	PushInSp	In Pos
0	Absolute	100	5.00	0	0	1.00
1	Absolute	100	10.00	0	0	1.00
2	Absolute	100	20.00	0	0	1.00
3	Absolute	200	30.00	0	0	1.00
4	Absolute	200	40.00	0	0	1.00
5	Absolute	300	50.00	0	0	1.00
6	Absolute	300	60.00	0	0	1.00
7	Absolute	400	70.00	0	0	1.00
8	Absolute	400	80.00	0	0	1.00
9	Absolute	500	90.00	0	0	1.00
- Move Speed:** 20 (mm/sec)
- Move distance:** 0.50

- Jogging
- Start testing
- Step data setting
- Move for the constant rate
- Setting of jog and speed of the constant rate

### <When a TB (teaching box) is used>

- The simple screen without scrolling promotes ease of setting and operation.
- Choose an icon from the first screen to select a function.
- Set the step data and check the monitor on the second screen.



#### Example of setting the step data

1st screen

データ DATA	モニタ MONITOR	テスト TEST
アラーム ALARM	ジョグ JOG	設定 SETTING

2nd screen

Step No.	0
Posn	123.45 mm
Speed	100 mm/s

After entering the values, they can be registered by pressing “SET.”

#### Example of checking the operation status

1st screen

データ DATA	モニタ MONITOR	テスト TEST
アラーム ALARM	ジョグ JOG	設定 SETTING

2nd screen

Monitor	Axis 1
Step No.	1
Posn	12.34 mm
Speed	10 mm/s

The operation status can be checked.

### Teaching box screen

- Data can be set by inputting only the position and speed. (Other conditions are preset.)

Step	Axis 1
Step No.	0
Posn	50.00 mm
Speed	200 mm/s



Step	Axis 1
Step No.	1
Posn	80.00 mm
Speed	100 mm/s

# Step Data Input Type **JXC5H/6H Series**

## ⊙ “Normal Mode” for detailed setting

Select “Normal Mode” when detailed setting is required.

- Step data can be set in detail.
- Parameters can be set.
- Signals and terminal status can be monitored.
- JOG and constant rate movement, return to origin, test drive, and testing of forced output can be performed.

**<When a PC is used>**  
**Controller setting software**

- Step data setting, parameter setting, monitoring, teaching, etc., are displayed in different windows.

The image shows four software windows from the SMC controller setting software:

- Step data setting window:** A table with columns for No., Move M, Speed, Position, Accel, Decel, Pushing, and Z. It lists 10 absolute steps with various speed and position values.
- Parameter setting window:** A list of parameters such as Controller ID, IO pattern, AC/DEC pattern, Sraolun rate, Stroke(+), Stroke(-), Max speed, Max ACC/DEC, Def. In position, O/S offset, Max. force, Para. protect, Enable SW, and Unit name.
- Monitoring window:** A control panel with buttons for IN 1-5, DRIVE, RESET, SVON, OUT 1-5, BUSY, AREA, and SETUP. It also shows a 'JOG Control' section with buttons for JXC, DIRECT, and Position.
- Teaching window:** A window for teaching parameters, showing 'Return to ORG / Stop', 'JOG', and 'More distance' options.

**<When a TB (teaching box) is used>**

- Multiple step data can be stored in the teaching box and transferred to the controller.
- Continuous test drive by up to 5 step data

**Teaching box screen**

- Each function (step data setting, test drive, monitoring, etc.) can be selected from the main menu.

The diagram shows the navigation flow on the teaching box screen:

- Main menu screen:** Options include Menu, Step data, Parameter, and Test.
- Step data setting screen:** Shows 'Step No.' (0) and 'Movement MOD'.
- Test screen:** Shows 'Test DRV', 'Step No.' (1), and 'Posn 123.45 mm'. A 'Stop' button is visible.
- Monitoring screen:** Shows 'Out mon' for Axis 1 with indicators for BUSY[ ], SVRE[●], and SETON[ ].

**The actuator and controller are provided as a set.** (They can be ordered separately as well.)

Confirm that the combination of the controller and actuator is correct.  
**<Check the following before use.>**

- ① Check the actuator label for the model number. This number should match that of the controller.
- ② Check that the Parallel I/O configuration matches (NPN or PNP).

The image shows the physical components:

- Actuator:** A long metal rail with a motor. A callout box shows the label 'LEFS25GB-400' and 'SMC JAPAN MX'.
- Controller:** A vertical blue and white unit. A callout box shows the label 'LEFS25GB-400' and 'NPN'.

## Function

Item	Step data input type JXC5H/6H
Step data and parameter setting	<ul style="list-style-type: none"> <li>Input from controller setting software (PC)</li> <li>Input from teaching box</li> </ul>
Step data “position” setting	<ul style="list-style-type: none"> <li>Numerical value input from controller setting software (PC) or teaching box</li> <li>Input numerical value</li> <li>Direct teaching</li> <li>JOG teaching</li> </ul>
Number of step data	64 points
Operation command (I/O signal)	Step No. [IN <sup>*</sup> ] input ⇒ [DRIVE] input
Completion signal	[INP] output

## Setting Items

TB: Teaching box PC: Controller setting software

Item		Contents	Easy Mode		Normal Mode	Step data input type JXC5H/6H
			TB	PC	TB/PC	
Step data setting (Excerpt)	Movement MOD	Selection of “absolute position” and “relative position”	△	●	●	Set at ABS/INC
	Speed	Transfer speed	●	●	●	Set in units of 1 mm/s
	Position	[Position]: Target position [Pushing]: Pushing start position*1	●	●	●	Set in units of 0.01 mm
	Acceleration/Deceleration	Acceleration/deceleration during movement	●	●	●	Set in units of 1 mm/s <sup>2</sup>
	Pushing force	Rate of force during pushing operation*1	●	●	●	Set in units of 1%
	Trigger LV	Target force during pushing operation*1	△	●	●	Set in units of 1%
	Pushing speed	Speed during pushing operation*1	△	●	●	Set in units of 1 mm/s
	Moving force	Force during positioning operation	△	●	●	Set to 100%
	Area output	Conditions for area output signal to turn ON	△	●	●	Set in units of 0.01 mm
	In position	[Position]: Width to the target position [Pushing]: How much it moves during pushing	△	●	●	Set to 0.5 mm or more (Units: 0.01 mm)
Parameter setting (Excerpt)	Stroke (+)	+ side position limit	×	×	●	Set in units of 0.01 mm
	Stroke (-)	- side position limit	×	×	●	Set in units of 0.01 mm
	ORIG direction	Direction of the return to origin can be set.	×	×	●	Compatible
	ORIG speed	Speed during return to origin	×	×	●	Set in units of 1 mm/s
	ORIG ACC	Acceleration during return to origin	×	×	●	Set in units of 1 mm/s <sup>2</sup>
Test	JOG		●	●	●	Continuous operation at the set speed can be tested while the switch is being pressed.
	MOVE		×	●	●	Operation at the set distance and speed from the current position can be tested.
	Return to ORIG		●	●	●	Compatible
	Test drive	Operation of the specified step data	●	●	● (Continuous operation)	Compatible
	Forced output	ON/OFF of the output terminal can be tested.	×	×	●	Compatible
Monitor	DRV mon	Current position, speed, force, and the specified step data can be monitored.	●	●	●	Compatible
	In/Out mon	Current ON/OFF status of the input and output terminal can be monitored.	×	×	●	Compatible
ALM	Status	Alarm currently being generated can be confirmed.	●	●	●	Compatible
	ALM Log record	Alarms generated in the past can be confirmed.	×	×	●	Compatible
File	Save/Load	Step data and parameters can be saved, forwarded, and deleted.	×	×	●	Compatible
Other	Language	Can be changed to Japanese or English	●	●	●	Compatible

△: Can be set from TB Ver. 2.\*\* (The version information is displayed on the initial screen.)

\*1 Check the catalog and operation manual of each actuator model which is capable of performing pushing operations.

The “Specifications” table for models which are capable of performing pushing operations includes an item for the pushing force.

## Fieldbus Network

# EtherCAT/EtherNet/IP™/PROFINET

## Direct Input Type

## Step Motor Controller/JXC□ Series p. 50

Ether**CAT**®



Ether**Net/IP**™



**PROFI**®  
**NET**



### Two types of operation command

**Step no. defined operation:** Operate using the preset step data in the controller.

**Numerical data defined operation:** The actuator operates using values such as position and speed from the PLC.

### Numerical monitoring available

Numerical information, such as the current speed, current position, and alarm codes, can be monitored on the PLC.

### Transition wiring of communication cables

Two communication ports are provided.

PLC

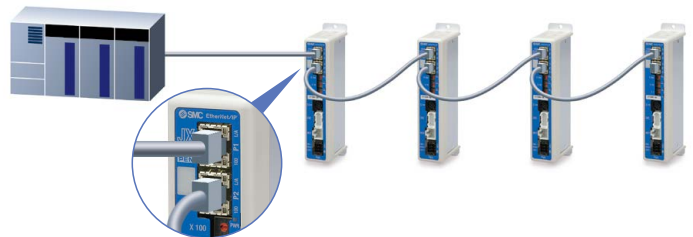

## Application

Communication protocols

Ether**CAT**®

Ether**Net/IP**™

**PROFI**®  
**NET**

**Both air and electric systems can be established under the same protocol.**

Electric Actuators

Air Cylinders

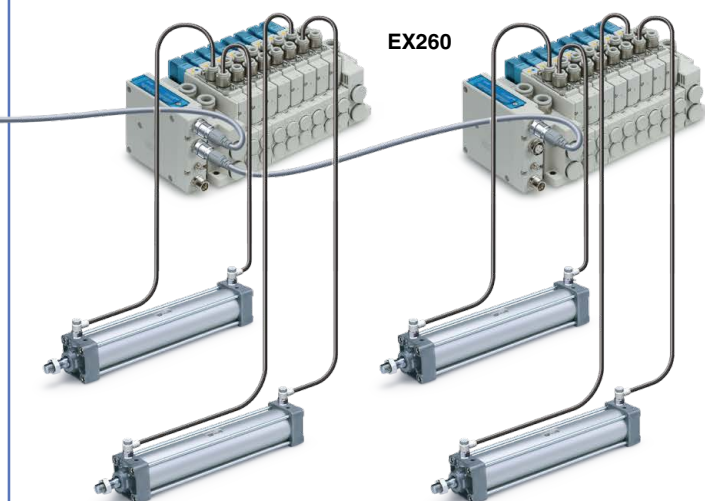
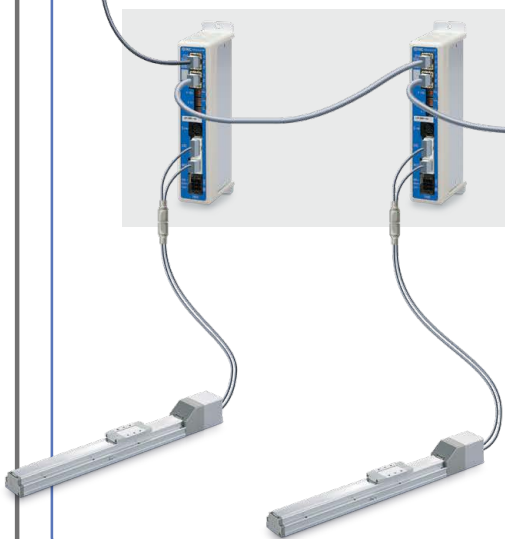

System Construction/General Purpose I/O

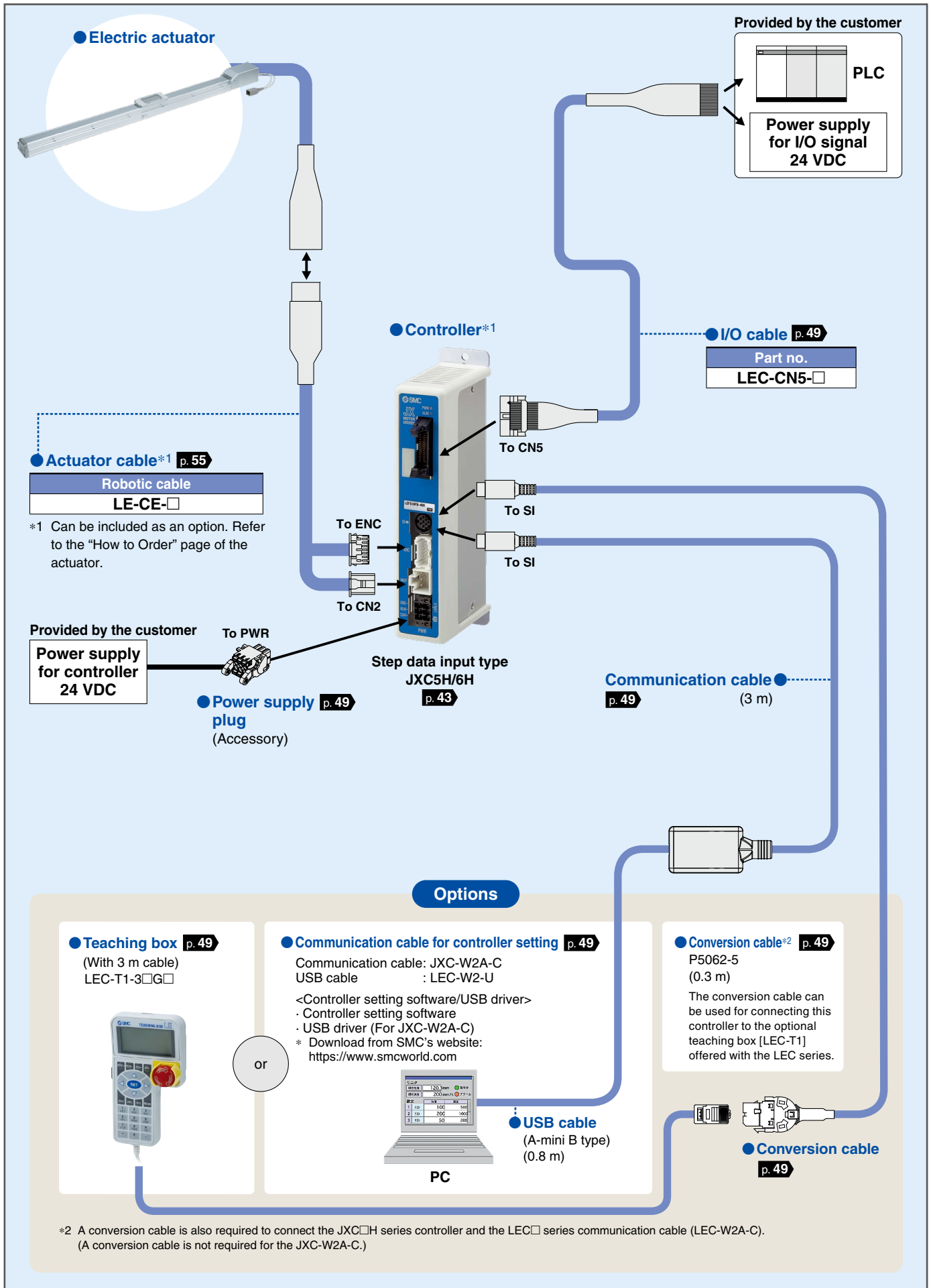

## System Construction/Fieldbus Network (EtherCAT/EtherNet/IP™/PROFINET Direct Input Type)

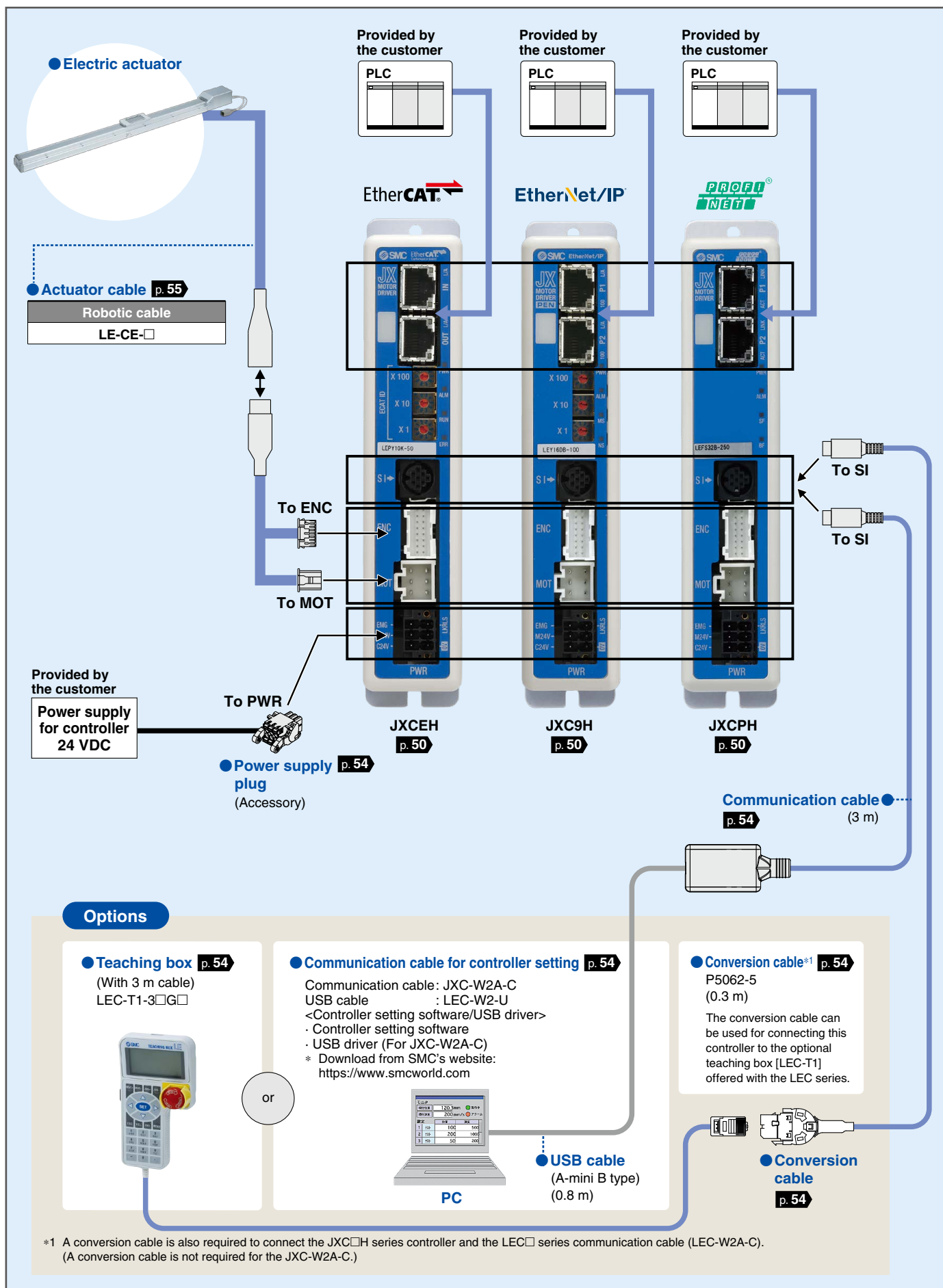



# Electric Actuator

## High Performance Slider Type

### Slider Type/Ball Screw Drive LEFS□G Series

Battery-less Absolute (Step Motor 24 VDC)

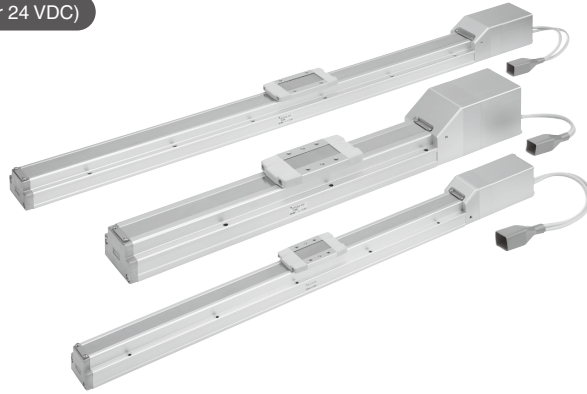

Model Selection

LEFS□G Series

## CONTENTS

### High Performance Slider Type/Ball Screw Drive LEFS□G Series p. 8

Battery-less Absolute (Step Motor 24 VDC)

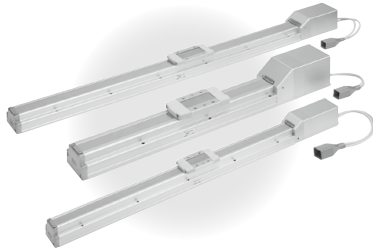

Model Selection .....	p. 9
How to Order .....	p. 17
Specifications .....	p. 19
Dimensions .....	p. 21
Auto Switch Mounting .....	p. 37

Auto Switch

JXC5H/6H Series

### Controllers JXC□H Series p. 42

High Performance Controller (Step Data Input Type) JXC5H/6H Series Battery-less Absolute (Step Motor 24 VDC)



How to Order .....	p. 43
Specifications .....	p. 43
Dimensions .....	p. 45
Options .....	p. 49
Actuator Cable .....	p. 55

JXCEH/9H/PH Series

High Performance Step Motor Controller JXCEH/9H/PH Series Battery-less Absolute (Step Motor 24 VDC)



How to Order .....	p. 50
Specifications .....	p. 51
Dimensions .....	p. 52
Options .....	p. 54
Actuator Cable .....	p. 55

Battery-less Absolute Encoder Type Specific Product Precautions ..... p. 56

CE/UKCA/UL-compliance List ..... p. 57

# Model Selection

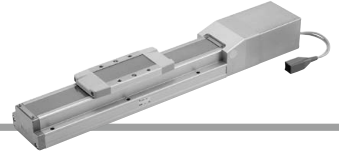

## Selection Procedure



## Selection Example

### Operating conditions

- Workpiece mass: 10 [kg]
- Speed: 300 [mm/s]
- Acceleration/Deceleration: 10000 [mm/s<sup>2</sup>]
- Stroke: 200 [mm]
- Mounting orientation: Horizontal upward
- Workpiece mounting condition:

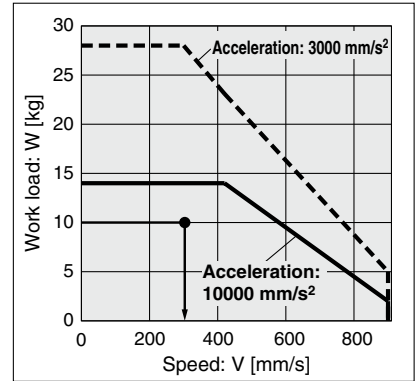
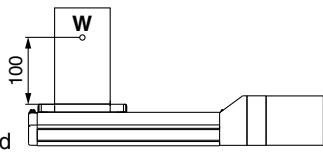

<Speed-Work load graph>  
(LEFS25GA/Battery-less absolute)

**Step 1 Check the work load-speed.** <Speed-Work load graph> (pages 10 to 13)  
Select a model based on the workpiece mass and speed while referencing the speed-work load graph.

Selection example) The **LEFS25GA-200** can be temporarily selected as a possible candidate based on the graph shown on the right side.

### Step 2 Check the cycle time.

Calculate the **cycle time** using the following calculation method.

#### Cycle time:

T can be found from the following equation.

$$T = T1 + T2 + T3 + T4 \text{ [s]}$$

- T1: Acceleration time and T3: Deceleration time can be found by the following equation.

$$T1 = V/a1 \text{ [s]} \quad T3 = V/a2 \text{ [s]}$$

- T2: Constant speed time can be found from the following equation.

$$T2 = \frac{L - 0.5 \cdot V \cdot (T1 + T3)}{V} \text{ [s]}$$

- T4: Settling time varies depending on the conditions such as actuator types, load, and in position of the step data. Reference value for settling time: 0.15 s or less. The following value is used for this calculation.

$$T4 = 0.15 \text{ [s]}$$

Calculation example)

T1 to T4 can be calculated as follows.

$$T1 = V/a1 = 300/10000 = 0.03 \text{ [s]}$$

$$T3 = V/a2 = 300/10000 = 0.03 \text{ [s]}$$

$$T2 = \frac{L - 0.5 \cdot V \cdot (T1 + T3)}{V} = \frac{200 - 0.5 \cdot 300 \cdot (0.03 + 0.03)}{300} = 0.64 \text{ [s]}$$

$$T4 = 0.15 \text{ [s]}$$

The **cycle time** can be found as follows.

$$T = T1 + T2 + T3 + T4 = 0.03 + 0.64 + 0.03 + 0.15 = 0.85 \text{ [s]}$$

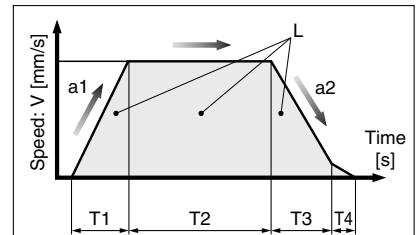

- L : Stroke [mm] ... (Operating condition)
- V : Speed [mm/s] ... (Operating condition)
- a1: Acceleration [mm/s<sup>2</sup>] ... (Operating condition)
- a2: Deceleration [mm/s<sup>2</sup>] ... (Operating condition)

- T1: Acceleration time [s]  
Time until reaching the set speed
- T2: Constant speed time [s]  
Time while the actuator is operating at a constant speed
- T3: Deceleration time [s]  
Time from the beginning of the constant speed operation to stop
- T4: Settling time [s]  
Time until positioning is completed

### Step 3 Check the allowable moment.

<Static allowable moment> (page 13)  
<Dynamic allowable moment> (pages 14, 15)

Confirm the moment that applies to the actuator is within the allowable range for both static and dynamic conditions.

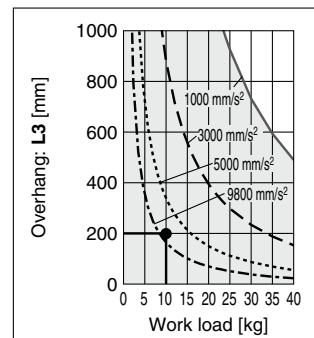
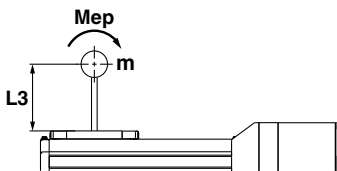

Based on the above calculation result, the **LEFS25GA-200** should be selected.

### Speed-Work Load Graph (Guide)

\* The following graphs show the values when the moving force is 100%.

#### LEFS16GA/Ball Screw Drive

##### Horizontal/Lead 10

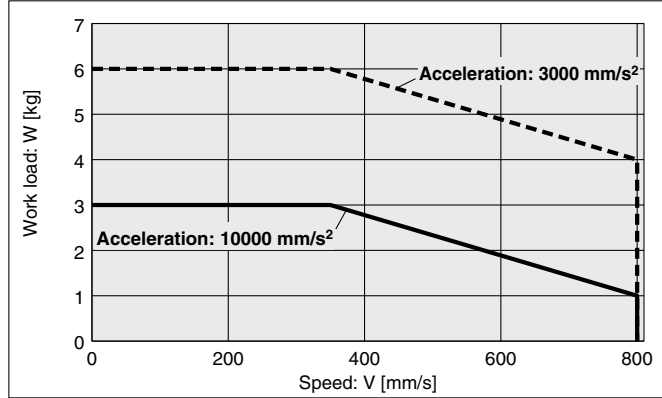

##### Vertical/Lead 10

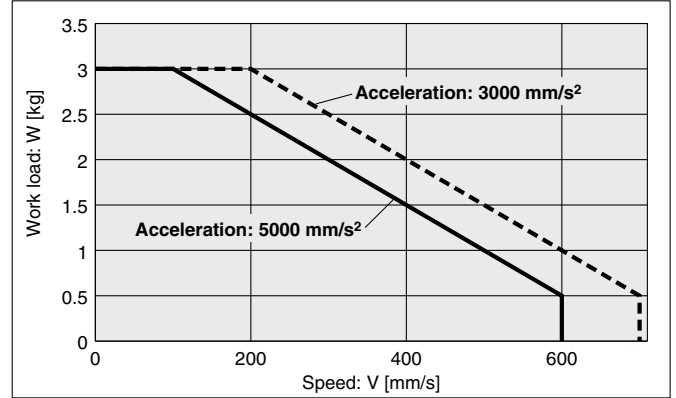

#### LEFS16GB/Ball Screw Drive

##### Horizontal/Lead 5

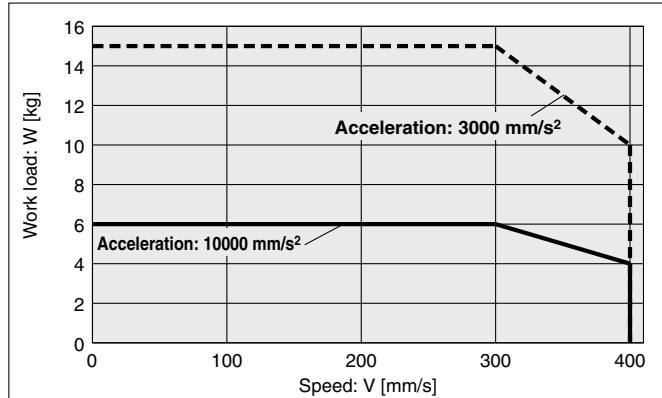

##### Vertical/Lead 5

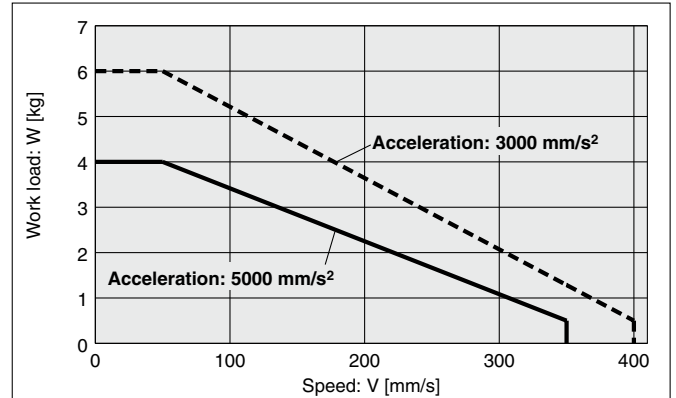

**Operating temperature:** Use products with a duty ratio of 100% or less when the temperature is below 30°C and with a duty ratio of 35% or less when the temperature exceeds 30°C.

Model Selection

LEFS□G Series

Auto Switch

JXC5H/6H Series

JXCEH/9H/PH Series

## Speed-Work Load Graph (Guide)

\* The following graphs show the values when the moving force is 100%.

### LEFS25GH/Ball Screw Drive

#### Horizontal/Lead 20

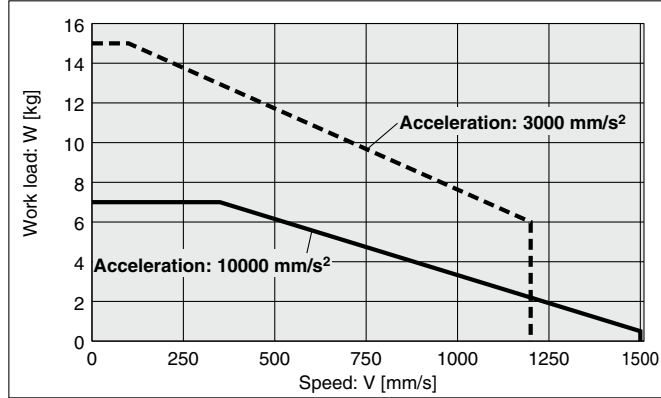

#### Vertical/Lead 20

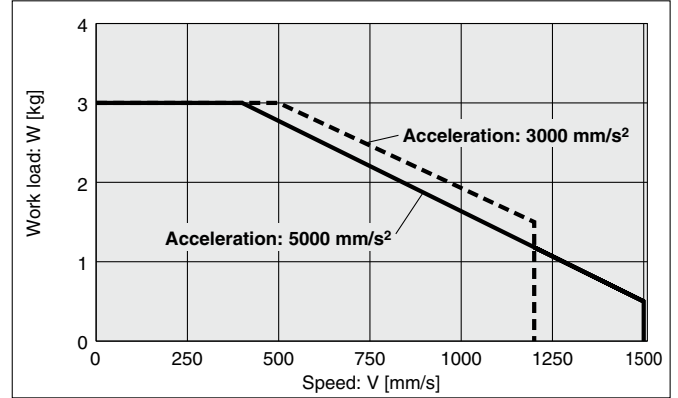

### LEFS25GA/Ball Screw Drive

#### Horizontal/Lead 12

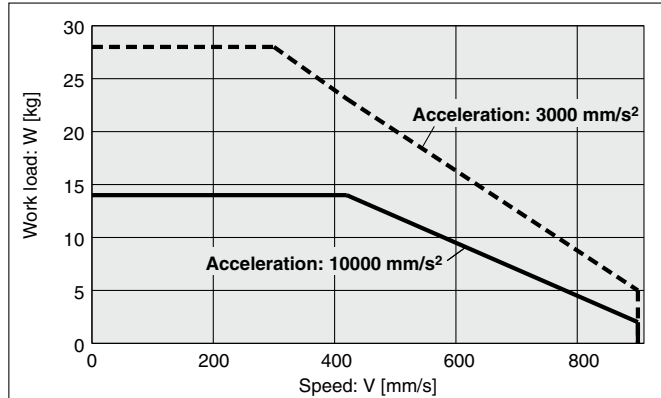

#### Vertical/Lead 12

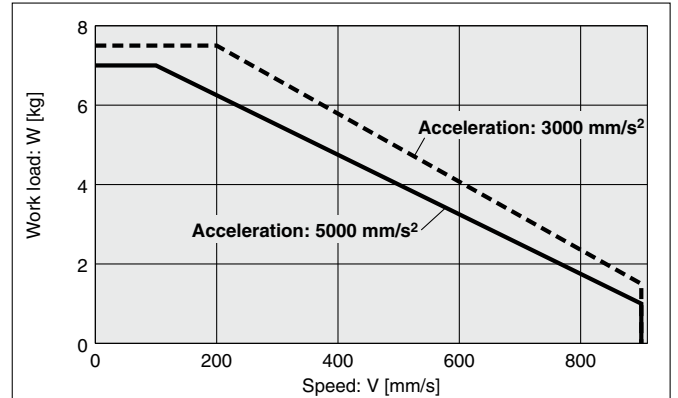

### LEFS25GB/Ball Screw Drive

#### Horizontal/Lead 6

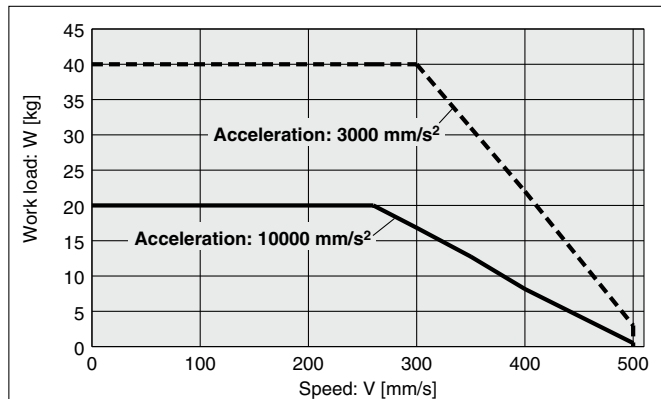

#### Vertical/Lead 6

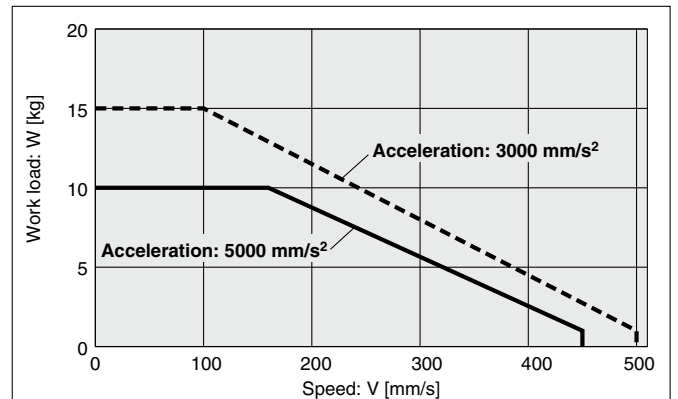

**Operating temperature:** Use products with a duty ratio of 100% or less when the temperature is below 30°C and with a duty ratio of 35% or less when the temperature exceeds 30°C.

**Speed-Work Load Graph (Guide)**

\* The following graphs show the values when the moving force is 100%.

**LEFS32GH/Ball Screw Drive**

**Horizontal/Lead 24**

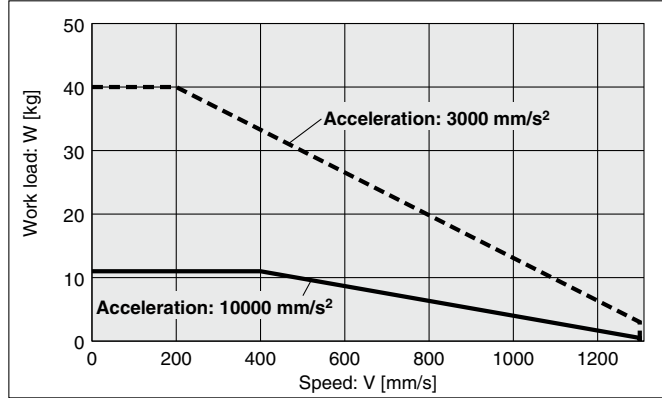

**Vertical/Lead 24**

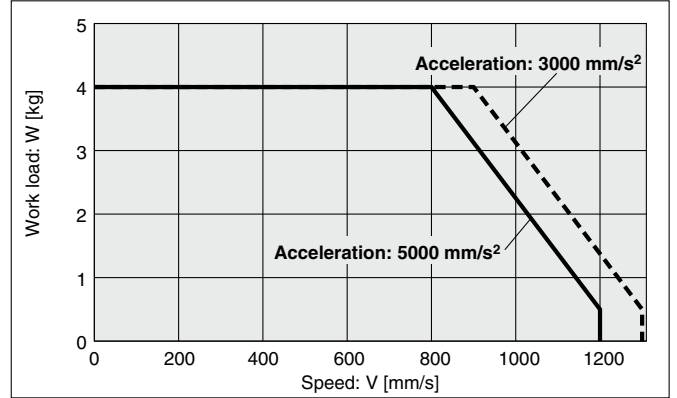

**LEFS32GA/Ball Screw Drive**

**Horizontal/Lead 16**

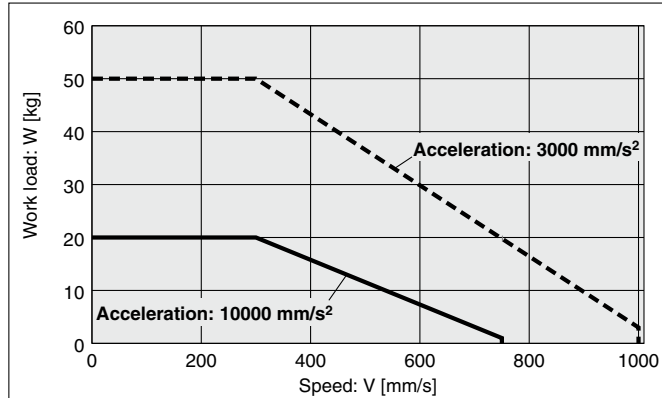

**Vertical/Lead 16**

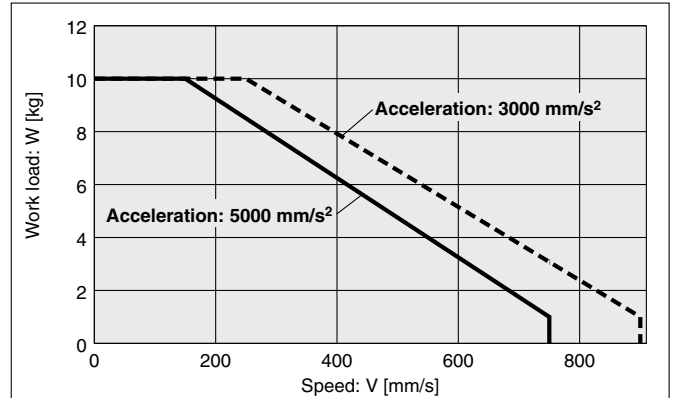

**LEFS32GB/Ball Screw Drive**

**Horizontal/Lead 8**

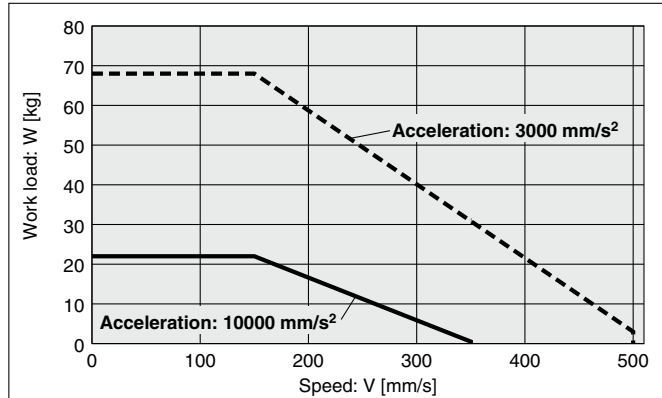

**Vertical/Lead 8**

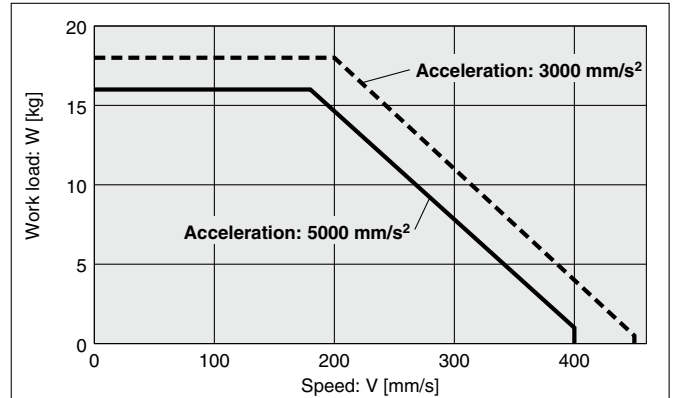

**Operating temperature:** Use products with a duty ratio of 100% or less when the temperature is below 30°C and with a duty ratio of 35% or less when the temperature exceeds 30°C.

Model Selection

LEFS  G Series

Auto Switch

JXC5H/6H Series

JXCEH/9H/PH Series

## Speed-Work Load Graph (Guide)

\* The following graphs show the values when the moving force is 100%.

### LEFS40GH/Ball Screw Drive

#### Horizontal/Lead 30

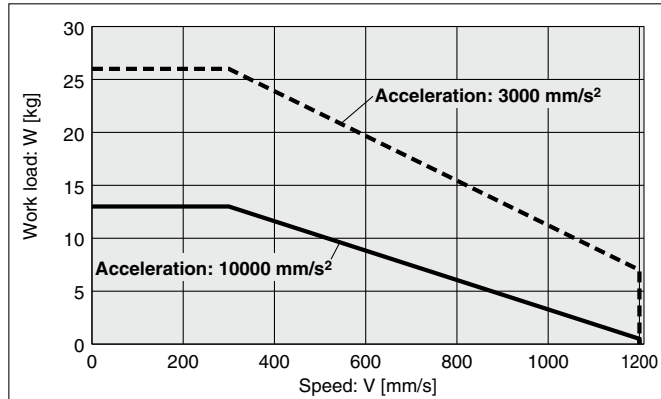

#### Vertical/Lead 30

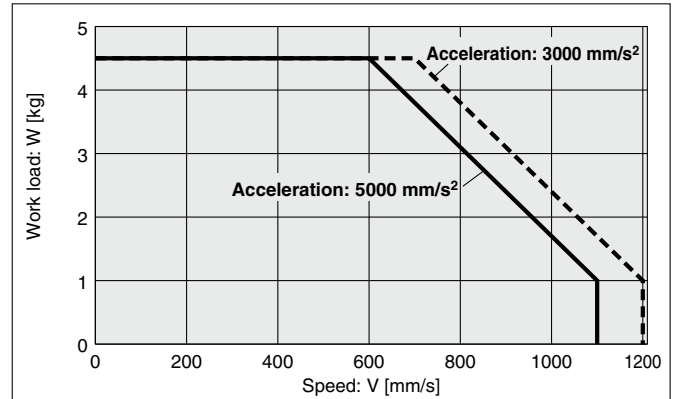

### LEFS40GA/Ball Screw Drive

#### Horizontal/Lead 20

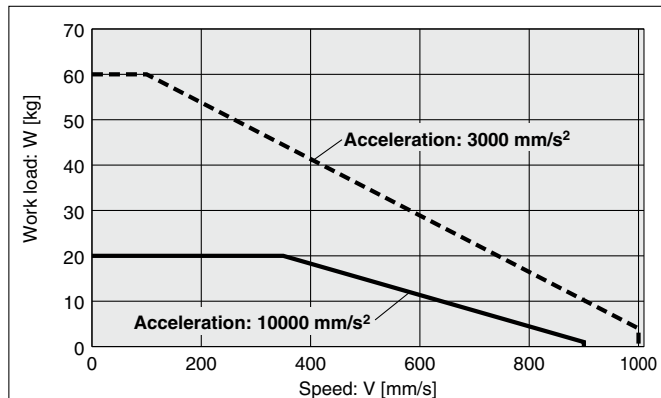

#### Vertical/Lead 20

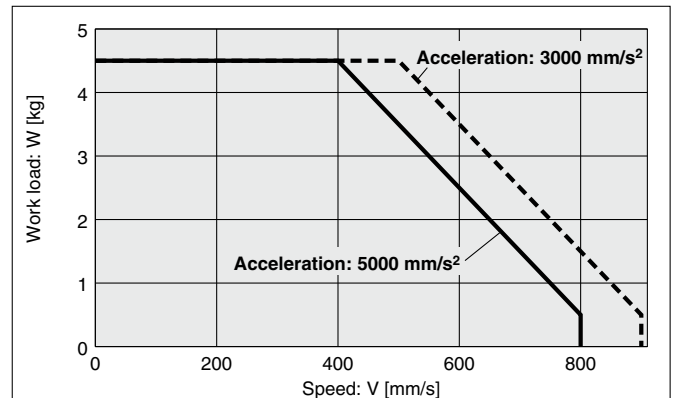

### LEFS40GB/Ball Screw Drive

#### Horizontal/Lead 10

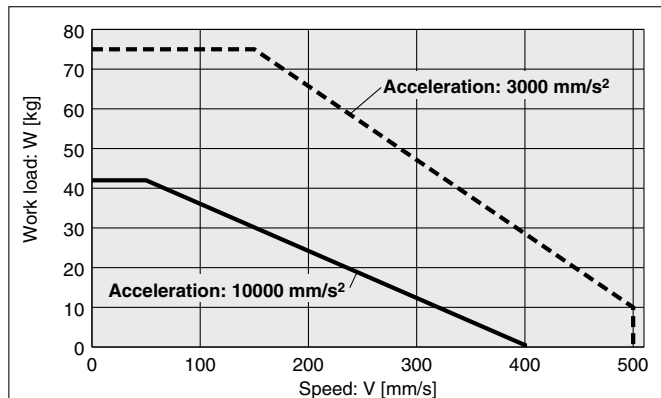

#### Vertical/Lead 10

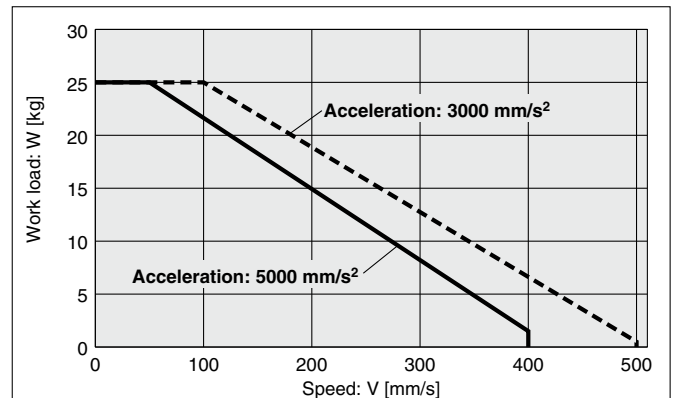

Operating temperature: Use products with a duty ratio of 100% or less when the temperature is below 30°C and with a duty ratio of 35% or less when the temperature exceeds 30°C.

## Static Allowable Moment\*1

Model	Size	Pitching	Yawing	Rolling
LEFS□G	16	10.0	10.0	20.0
	25	27.0	27.0	52.0
	32	46.0	46.0	101.0
	40	110.0	110.0	207.0

\*1 The static allowable moment is the amount of static moment which can be applied to the actuator when it is stopped. If the product is exposed to impact or repeated load, be sure to take adequate safety measures when using the product.

**Dynamic Allowable Moment**

\* These graphs show the amount of allowable overhang (guide unit) when the center of gravity of the workpiece overhangs in one direction.

Acceleration ——— 1000 mm/s<sup>2</sup>    - - - 3000 mm/s<sup>2</sup>    ····· 5000 mm/s<sup>2</sup>    - - - - 10000 mm/s<sup>2</sup>

Orientation	Load overhanging direction m : Work load [kg] Me: Allowable moment [N·m] L : Overhang to the work load center of gravity [mm]	Model			
		LEFS16G	LEFS25G	LEFS32G	LEFS40G
Horizontal/Bottom	X L1 [mm]				
	Y L2 [mm]				
	Z L3 [mm]				
Wall	X L4 [mm]				
	Y L5 [mm]				
	Z L6 [mm]				

Model Selection

LEFS□G Series

Auto Switch

JXC5H/6H Series

JXCEH/9H/PH Series

## Dynamic Allowable Moment

\* These graphs show the amount of allowable overhang (guide unit) when the center of gravity of the workpiece overhangs in one direction.

Acceleration ——— 1000 mm/s<sup>2</sup>    - - - 3000 mm/s<sup>2</sup>    ······ 5000 mm/s<sup>2</sup>

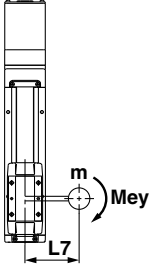
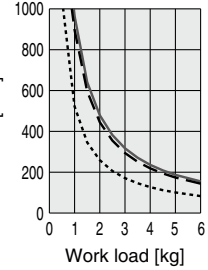
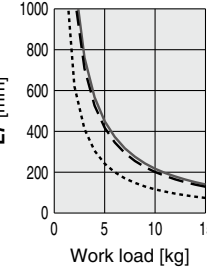
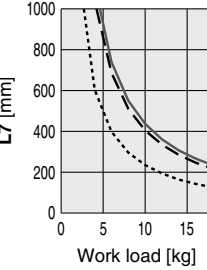
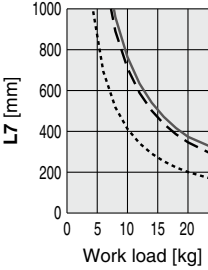
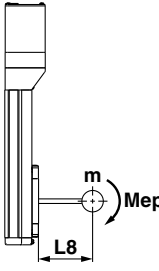
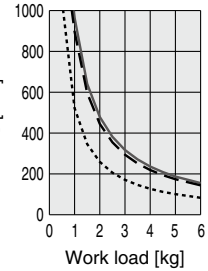
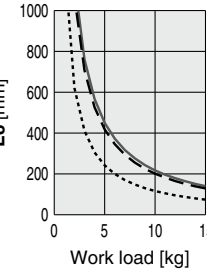
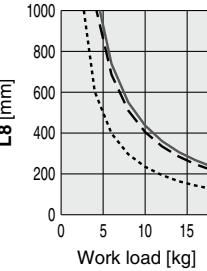
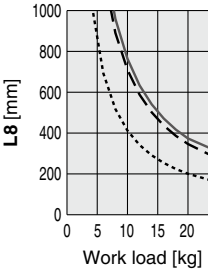
Orientation	Load overhanging direction m : Work load [kg] Me: Allowable moment [N·m] L : Overhang to the work load center of gravity [mm]	Model			
		LEFS16G	LEFS25G	LEFS32G	LEFS40G
Vertical	Y 				
	Z 				

## Calculation of Guide Load Factor

- Decide operating conditions.

Model: LEFS□G

Size: 25/32/40

Mounting orientation: Horizontal/Bottom/Wall/Vertical

Acceleration [mm/s<sup>2</sup>]: a

Work load [kg]: m

Work load center position [mm]: Xc/Yc/Zc

- Select the target graph while referencing the model, size, and mounting orientation.

- Based on the acceleration and work load, find the overhang [mm]: Lx/Ly/Lz from the graph.

- Calculate the load factor for each direction.

$$\alpha_x = X_c/L_x, \alpha_y = Y_c/L_y, \alpha_z = Z_c/L_z$$

- Confirm the total of  $\alpha_x$ ,  $\alpha_y$ , and  $\alpha_z$  is 1 or less.

$$\alpha_x + \alpha_y + \alpha_z \leq 1$$

When 1 is exceeded, please consider a reduction of acceleration and work load, or a change of the work load center position and series.

### Mounting orientation

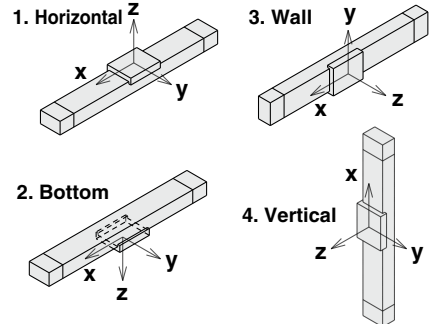

### Example

- Operating conditions

Model: LEFS40G

Size: 40

Mounting orientation: Horizontal

Acceleration [mm/s<sup>2</sup>]: 3000

Work load [kg]: 20

Work load center position [mm]: Xc = 0, Yc = 50, Zc = 200

- Select the graphs for horizontal of the LEFS40G on page 14.

- Lx = 350 mm, Ly = 250 mm, Lz = 1000 mm

- The load factor for each direction can be found as follows.

$$\alpha_x = 0/350 = 0$$

$$\alpha_y = 50/250 = 0.2$$

$$\alpha_z = 200/1000 = 0.2$$

- $\alpha_x + \alpha_y + \alpha_z = 0.4 \leq 1$

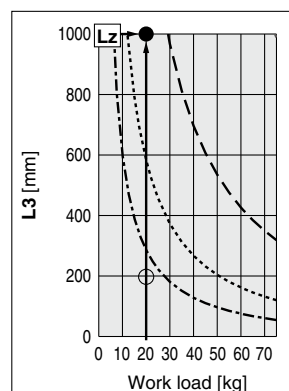
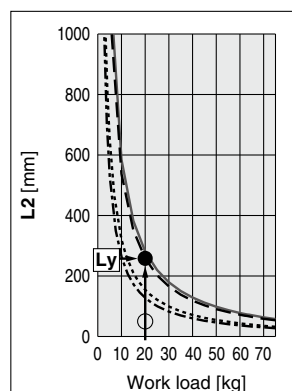
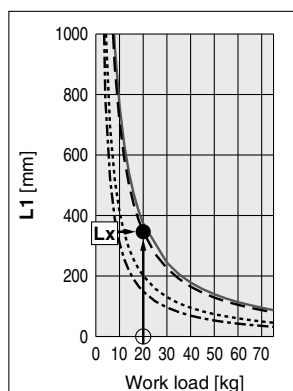



**Table Accuracy (Reference Value)**

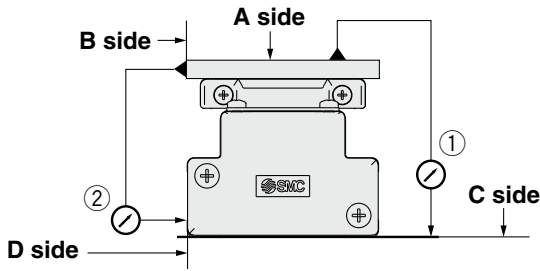

Model	Traveling parallelism [mm] (Every 300 mm)	
	① C side traveling parallelism to A side	② D side traveling parallelism to B side
LEFS16G	0.05	0.03
LEFS25G	0.05	0.03
LEFS32G	0.05	0.03
LEFS40G	0.05	0.03

\* Traveling parallelism does not include the mounting surface accuracy. (Excludes when the stroke exceeds 2000 mm)

**Table Displacement (Reference Value)**

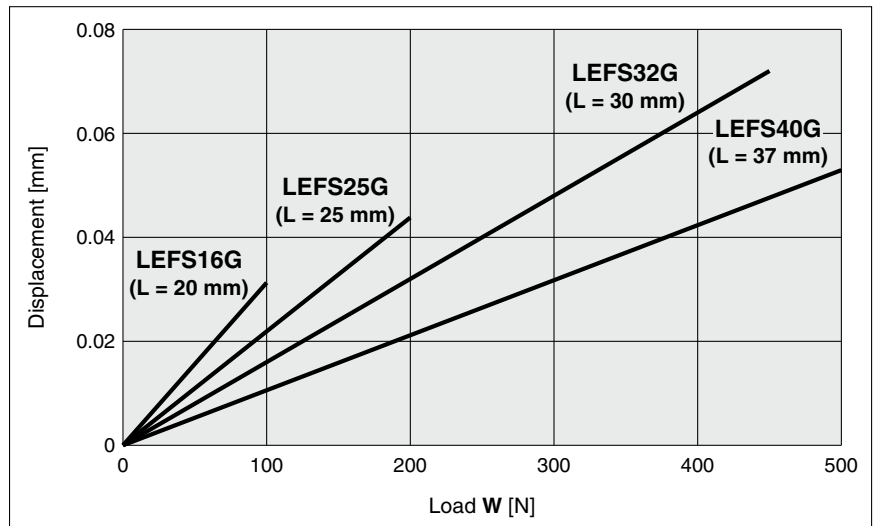
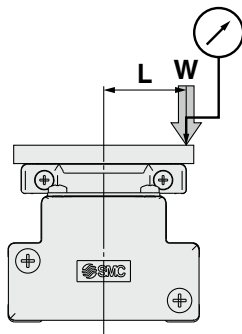

\* This displacement is measured when a 15 mm aluminum plate is mounted and fixed on the table.  
 \* Check the clearance and play of the guide separately.

**Overhang Displacement Due to Table Clearance (Initial Reference Value)**

**Basic type**

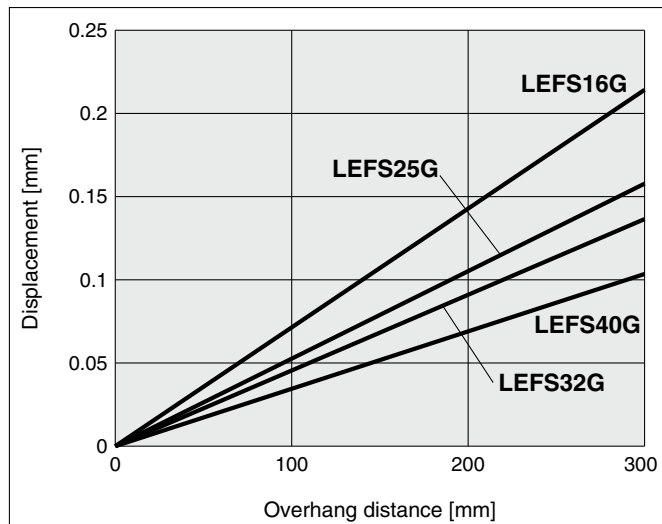

**High-precision type**

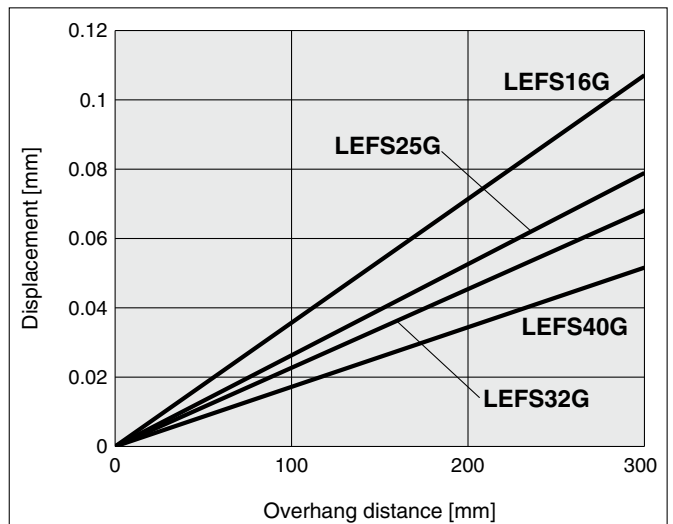

# High Performance Slider Type Ball Screw Drive LEFS□G Series LEFS16, 25, 32, 40



\* For details, refer to page 57 and onward.



## How to Order

LEFS **H** **25** **G** **B** - **200** **C** **N** **K** - **R1** **C5H73**

1
2
3
4
5
6
7
8
9
10
11
12

For details on controllers, refer to the next page.

### 1 Accuracy

Nil	Basic type
H	High-precision type

### 2 Size

16
25
32
40

### 3 Motor mounting position

Nil	In-line
R	Right side parallel
L	Left side parallel

### 4 Motor type

Symbol	Type	Applicable size				Compatible controllers
		LEFS16	LEFS25	LEFS32	LEFS40	
G	High performance (Battery-less absolute)	●	●	●	●	JXC5H JXC6H JXCEH JXC9H JXCPH

### 5 Lead [mm]

Symbol	LEFS16	LEFS25	LEFS32	LEFS40
H	—	20	24	30
A	10	12	16	20
B	5	6	8	10

### 6 Stroke\*1[mm]

Stroke	Size	Note
		Applicable stroke
50 to 500	16	50, 100, 150, 200, 250, 300, 350, 400, 450, 500
50 to 800	25	50, 100, 150, 200, 250, 300, 350, 400, 450, 500, 550, 600, 650, 700, 750, 800
50 to 1000	32	50, 100, 150, 200, 250, 300, 350, 400, 450, 500, 550, 600, 650, 700, 750, 800, 850, 900, 950, 1000
150 to 1200	40	150, 200, 250, 300, 350, 400, 450, 500, 550, 600, 650, 700, 750, 800, 850, 900, 950, 1000, 1100, 1200

### 7 Motor option

Nil	Without option
B	With lock

### 8 Auto switch compatibility (In-line only)\*2 \*3 \*4 \*5 \*6

Nil	None
C	With (Includes 1 mounting bracket)

### 9 Grease application (Seal band part)

Nil	With
N	Without (Roller specification)

### 10 Positioning pin hole

Nil	Housing B bottom*6	
K	Body bottom 2 locations	

### 11 Actuator cable type/length

Robotic cable [m]			
Nil	None	R8	8*7
R1	1.5	RA	10*7
R3	3	RB	15*7
R5	5	RC	20*7

For auto switches, refer to pages 37 to 40.

**12 Controller**

Nil	Without controller
C□H□□	With controller



**Controller type**

5	Parallel I/O (NPN) type
6	Parallel I/O (PNP) type
E	EtherCAT
9	EtherNet/IP™
P	PROFINET

**Mounting**

7	Screw mounting
8*8	DIN rail

**Number of axes/Special specification**

H	1 axis/High performance type
---	------------------------------

**I/O cable length**

Nil	Without cable
1	1.5 m
3	3 m
5	5 m

- \*1 Please contact SMC for non-standard strokes as they are produced as special orders.
- \*2 Excluding the LEFS16
- \*3 If 2 or more are required, please order them separately. (Part no.: LEF-D-2-1 For details, refer to the **Web Catalog**.)
- \*4 The auto switches must be ordered separately. (For details, refer to the **Web Catalog**.)

- \*5 When "Nil" is selected, the product will not come with a built-in magnet for an auto switch, and so a mounting bracket cannot be secured. Be sure to select an appropriate model initially as the product cannot be changed to have auto switch compatibility after purchase.
- \*6 For details on the mounting method, refer to the **Web Catalog**.
- \*7 Produced upon receipt of order
- \*8 The DIN rail is not included. It must be ordered separately.

**⚠ Caution**

**[CE/UKCA-compliant products]**

EMC compliance was tested by combining the electric actuator LEF series and the controller JXC series. The EMC depends on the configuration of the customer's control panel and the relationship with other electrical equipment and wiring. Therefore, compliance with the EMC directive cannot be certified for SMC components incorporated into the customer's equipment under actual operating conditions. As a result, it is necessary for the customer to verify compliance with the EMC directive for the machinery and equipment as a whole.

**■ Trademark**

EtherNet/IP® is a registered trademark of ODVA, Inc.  
 EtherCAT® is registered trademark and patented technology, licensed by Beckhoff Automation GmbH, Germany.

**The actuator and controller are sold as a package.**

Confirm that the combination of the controller and actuator is correct.

**<Check the following before use.>**

- \*1 Check the actuator label for the model number. This number should match that of the controller.

**LEFS25GA-400**

\*1

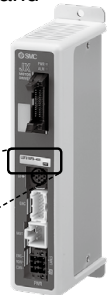

- \* Refer to the Operation Manual for using the products. Please download it via our website: <https://www.smcworld.com>

Type	Step data input type	EtherCAT direct input type	EtherNet/IP™ direct input type	PROFINET direct input type
Series	JXC5H JXC6H	JXCEH	JXC9H	JXCPH
Features	Parallel I/O	EtherCAT direct input	EtherNet/IP™ direct input	PROFINET direct input
Compatible motor	Step motor 24 VDC			
Max. number of step data	64 points			
Power supply voltage	24 VDC			
Reference page	43	50		

Model Selection

LEFS□G Series

Auto Switch

JXC5H/6H Series

JXCEH/9H/PH Series

## Specifications

Model		LEFS16G		LEFS25G			LEFS32G			LEFS40G				
Actuator specifications	Stroke [mm]*1	50 to 500		50 to 800			50 to 1000			150 to 1200				
	Work load [kg]*2	Horizontal		6	15	15	28	40	40	50	68	26	60	75
		Vertical		3	6	3	7.5	15	4	10	18	4.5	4.5	25
	Speed [mm/s]	Stroke range	Up to 400	10 to 800	5 to 400	20 to 1500	12 to 900	6 to 500	24 to 1300	16 to 1000	8 to 500	30 to 1200	20 to 1000	10 to 500
			401 to 450	10 to 700	5 to 360	20 to 1100	12 to 750	6 to 400	24 to 1300	16 to 950	8 to 500	30 to 1200	20 to 1000	10 to 500
			451 to 500	10 to 600	5 to 300	20 to 1100	12 to 750	6 to 400	24 to 1300	16 to 950	8 to 500	30 to 1200	20 to 1000	10 to 500
			501 to 600	—	—	20 to 900	12 to 540	6 to 270	24 to 1200	16 to 800	8 to 400	30 to 1200	20 to 1000	10 to 500
			601 to 700	—	—	20 to 630	12 to 420	6 to 230	24 to 930	16 to 620	8 to 310	30 to 1200	20 to 900	10 to 440
			701 to 800	—	—	20 to 550	12 to 330	6 to 180	24 to 750	16 to 500	8 to 250	30 to 1140	20 to 760	10 to 350
			801 to 900	—	—	—	—	—	24 to 610	16 to 410	8 to 200	30 to 930	20 to 620	10 to 280
			901 to 1000	—	—	—	—	—	24 to 500	16 to 340	8 to 170	30 to 780	20 to 520	10 to 250
			1001 to 1100	—	—	—	—	—	—	—	—	30 to 660	20 to 440	10 to 220
	1101 to 1200	—	—	—	—	—	—	—	—	30 to 570	20 to 380	10 to 190		
	Max. acceleration/deceleration [mm/s <sup>2</sup> ]	Horizontal	10000											
Vertical		5000												
Positioning repeatability [mm]	Basic type	±0.02												
	High-precision type	±0.015 (Lead H: ±0.02)												
Lost motion [mm]*3	Basic type	0.1 or less												
	High-precision type	0.05 or less												
Lead [mm]		10	5	20	12	6	24	16	8	30	20	10		
Impact/Vibration resistance [m/s <sup>2</sup> ]*4		50/20												
Actuation type		Ball screw (LEFS□), Ball screw + Belt (LEFS□ <sup>R</sup> )												
Guide type		Linear guide												
Static allowable moment*5 [N·m]	Mep (Pitching)	10		27			46			110				
	Mey (Yawing)	10		27			46			110				
	Mer (Rolling)	20		52			101			207				
Operating temperature range [°C]		5 to 40												
Operating humidity range [%RH]		90 or less (No condensation)												
Enclosure		IP30												
Electric specifications	Motor size	□28		□42			□56.4			□56.4				
	Motor type	Battery-less absolute (Step motor 24 VDC)												
	Encoder	Battery-less absolute encoder												
	Power supply voltage [V]	24 VDC ±10%												
	Power [W]*6 *8	Max. power 116		Max. power 126			Max. power 222			Max. power 222				
Lock unit specifications	Type*7	Non-magnetizing lock												
	Holding force [N]	29	59	47	78	157	72	108	216	75	113	245		
	Power [W]*8	2.9		5			5			5				
	Rated voltage [V]	24 VDC ±10%												

\*1 Please contact SMC for non-standard strokes as they are produced as special orders.

\*2 The max. work load at 3000 mm/s<sup>2</sup> acceleration and deceleration speed. For the speed, acceleration, and duty ratio according to the work load, check the "Speed-Work Load Graph" on pages 10 to 13.

Furthermore, if the cable length exceeds 5 m, the speed and work load specified in the "Speed-Work Load Graph" may decrease by up to 10% for each 5 m increase.

\*3 A reference value for correcting errors in reciprocal operation

\*4 Impact resistance: No malfunction occurred when the actuator was tested with a drop tester in both an axial direction and a perpendicular direction to the lead screw. (The test was performed with the actuator in the initial state.)

Vibration resistance: No malfunction occurred in a test ranging between 45 to 2000 Hz. The test was performed in both an axial direction and a perpendicular direction to the lead screw. (The test was performed with the actuator in the initial state.)

\*5 The static allowable moment is the amount of static moment which can be applied to the actuator when it is stopped.

If the product is exposed to impact or repeated load, be sure to take adequate safety measures when using the product.

\*6 Indicates the max. power during operation (including the controller)

This value can be used for the selection of the power supply.

\*7 With lock only

\*8 For an actuator with lock, add the power for the lock.

## Weight

Series	LEFS16G									
Stroke [mm]	50	100	150	200	250	300	350	400	450	500
Product weight [kg]	0.85	0.92	1.00	1.07	1.15	1.22	1.30	1.37	1.45	1.52
Additional weight with lock [kg]	0.12									

Series	LEFS25G															
Stroke [mm]	50	100	150	200	250	300	350	400	450	500	550	600	650	700	750	800
Product weight [kg]	1.70	1.84	1.98	2.12	2.26	2.40	2.54	2.68	2.82	2.96	3.10	3.24	3.38	3.52	3.66	3.80
Additional weight with lock [kg]	0.26															

Series	LEFS32G																			
Stroke [mm]	50	100	150	200	250	300	350	400	450	500	550	600	650	700	750	800	850	900	950	1000
Product weight [kg]	3.55	3.75	3.95	4.15	4.35	4.55	4.75	4.95	5.15	5.35	5.55	5.75	5.95	6.15	6.35	6.55	6.75	6.95	7.15	7.35
Additional weight with lock [kg]	0.53																			

Series	LEFS40G																			
Stroke [mm]	150	200	250	300	350	400	450	500	550	600	650	700	750	800	850	900	950	1000	1100	1200
Product weight [kg]	5.37	5.65	5.93	6.21	6.49	6.77	7.15	7.33	7.61	7.89	8.17	8.45	8.73	9.01	9.29	9.57	9.85	10.13	10.69	11.25
Additional weight with lock [kg]	0.53																			

Model Selection

LEFS□G Series

Auto Switch

JXC5H/6H Series

JXCEH/9H/PH Series

## Dimensions: In-line Motor

### LEFS16G

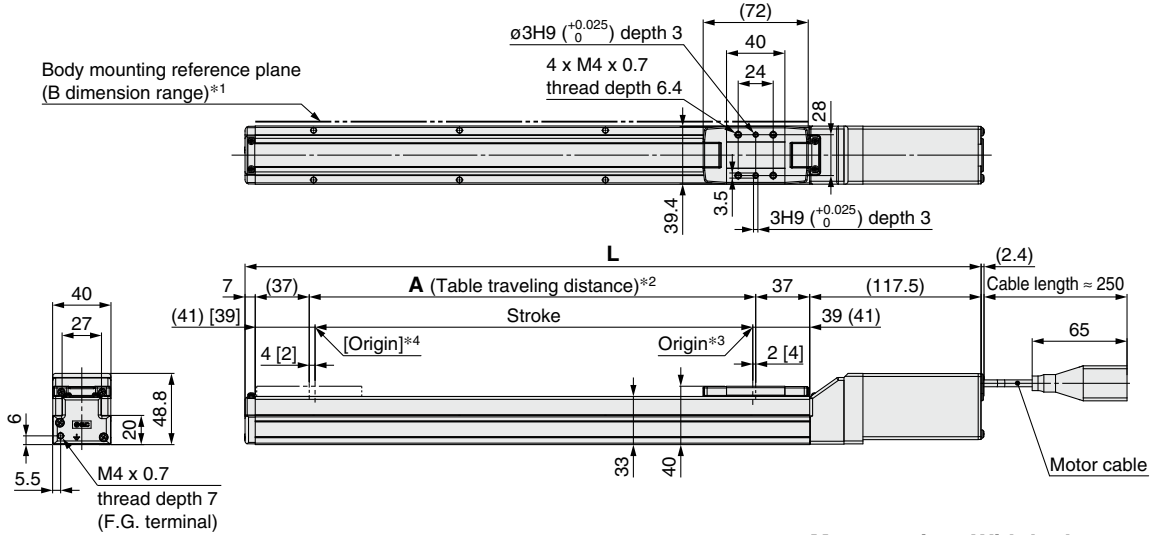

#### Motor option: With lock

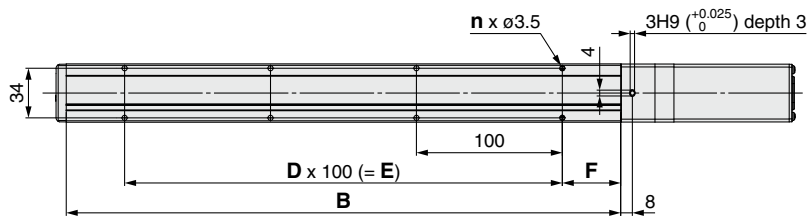
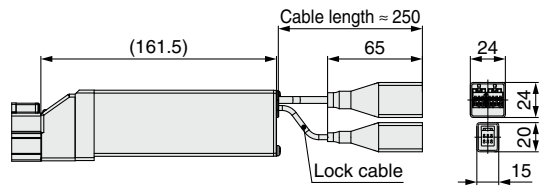

- \*1 When mounting the actuator using the body mounting reference plane, set the height of the opposite surface or pin to be 2 mm or more because of round chamfering. (Recommended height: 5 mm)  
In addition, be aware that surfaces other than the body mounting reference plane (B dimension range) may slightly protrude from the body mounting reference plane. Be sure to provide a clearance of 1 mm or more to avoid interference with workpieces, facilities, etc.
- \*2 This is the distance within which the table can move when it returns to origin.  
Make sure that workpieces mounted on the table do not interfere with other workpieces or the facilities around the table.
- \*3 Position after returning to origin
- \*4 [ ] for when the direction of return to origin has changed

#### Dimensions

Model	L		A	B	n	D	E	F
	Without lock	With lock						
LEFS16G□-50□	254.5	298.5	56	130	4	—	—	15
LEFS16G□-100□	304.5	348.5	106	180				
LEFS16G□-150□	354.5	398.5	156	230	6	2	200	40
LEFS16G□-200□	404.5	448.5	206	280				
LEFS16G□-250□	454.5	498.5	256	330	8	3	300	40
LEFS16G□-300□	504.5	548.5	306	380				
LEFS16G□-350□	554.5	598.5	356	430	10	4	400	40
LEFS16G□-400□	604.5	648.5	406	480				
LEFS16G□-450□	654.5	698.5	456	530	12	5	500	40
LEFS16G□-500□	704.5	748.5	506	580				

## Dimensions: In-line Motor

### LEFS16G

Positioning pin hole\*1 (Option): Body bottom

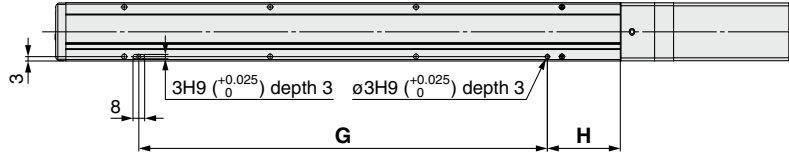

\*1 When using the body bottom positioning pin holes, do not simultaneously use the housing B bottom pin hole.

### Dimensions [mm]

Model	Positioning pin hole: <b>K</b>	
	<b>G</b>	<b>H</b>
LEFS16G□-50□	80	25
LEFS16G□-100□		50
LEFS16G□-150□		
LEFS16G□-200□		
LEFS16G□-250□		
LEFS16G□-300□		
LEFS16G□-350□		
LEFS16G□-400□	380	
LEFS16G□-450□	480	
LEFS16G□-500□		

Model Selection

LEFS□G Series

Auto Switch

JXC5H/6H Series

JXCEH/9H/PH Series

## Dimensions: In-line Motor

### LEFS25G

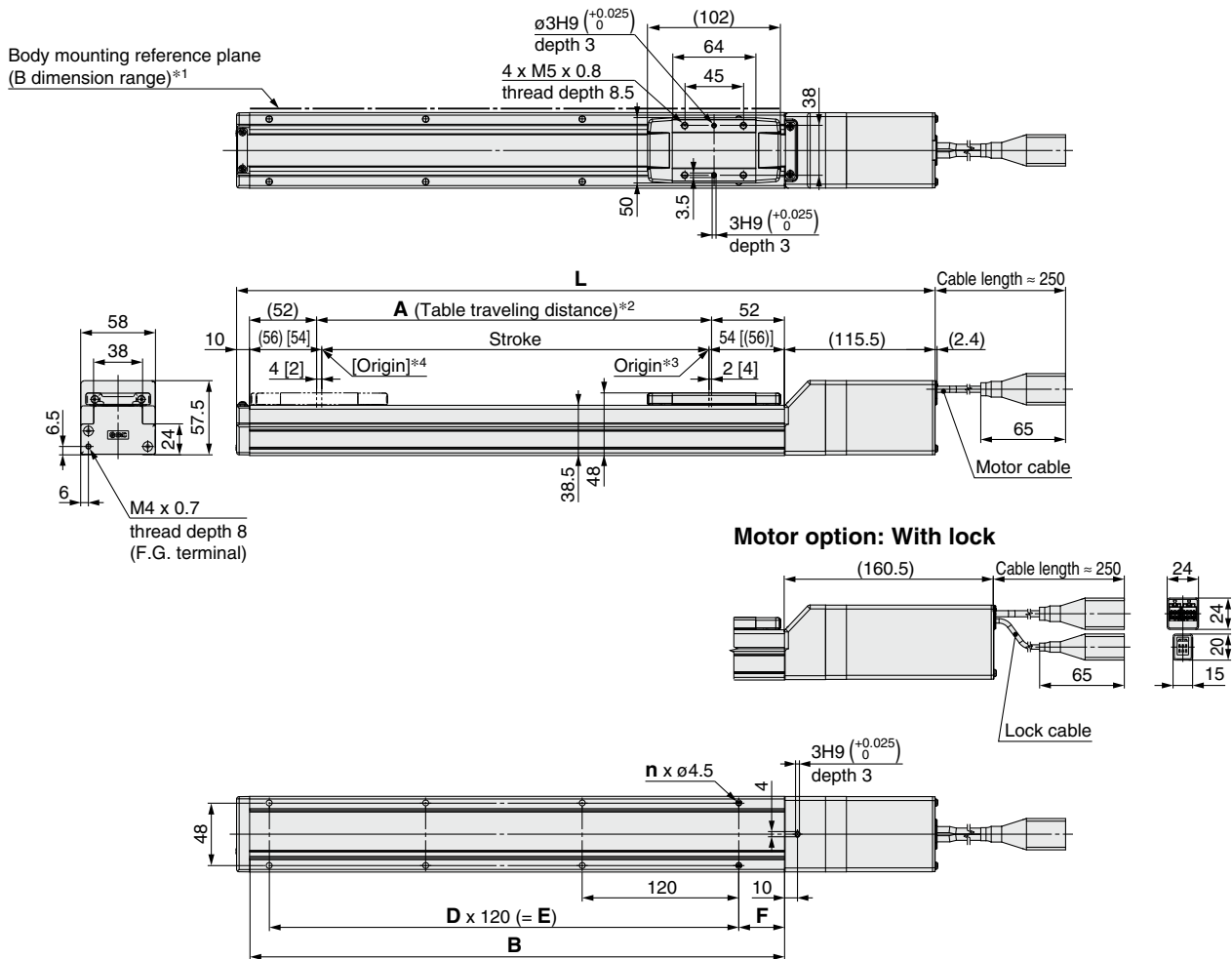

\*1 When mounting the actuator using the body mounting reference plane, set the height of the opposite surface or pin to be 3 mm or more because of round chamfering. (Recommended height: 5 mm)

In addition, be aware that surfaces other than the body mounting reference plane (B dimension range) may slightly protrude from the body mounting reference plane. Be sure to provide a clearance of 1 mm or more to avoid interference with workpieces, facilities, etc.

\*2 This is the distance within which the table can move when it returns to origin.

Make sure that workpieces mounted on the table do not interfere with other workpieces or the facilities around the table.

\*3 Position after returning to origin

\*4 [ ] for when the direction of return to origin has changed

### Dimensions

Model	L		A	B	n	D	E	F
	Without lock	With lock						
LEFS25G□-50□	285.5	330.5	56	160	4	—	—	20
LEFS25G□-100□	335.5	380.5	106	210				
LEFS25G□-150□	385.5	430.5	156	260				
LEFS25G□-200□	435.5	480.5	206	310	6	2	240	35
LEFS25G□-250□	485.5	530.5	256	360				
LEFS25G□-300□	535.5	580.5	306	410	8	3	360	
LEFS25G□-350□	585.5	630.5	356	460				
LEFS25G□-400□	635.5	680.5	406	510				
LEFS25G□-450□	685.5	730.5	456	560	10	4	480	
LEFS25G□-500□	735.5	780.5	506	610				
LEFS25G□-550□	785.5	830.5	556	660	12	5	600	
LEFS25G□-600□	835.5	880.5	606	710				
LEFS25G□-650□	885.5	930.5	656	760				
LEFS25G□-700□	935.5	980.5	706	810	14	6	720	
LEFS25G□-750□	985.5	1030.5	756	860				
LEFS25G□-800□	1035.5	1080.5	806	910	16	7	840	



## Dimensions: In-line Motor

### LEFS25G

Positioning pin hole\*1 (Option): Body bottom

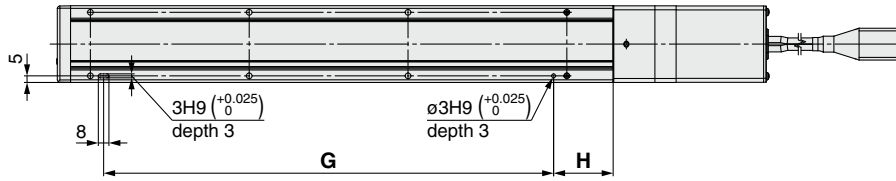

\*1 When using the body bottom positioning pin holes, do not simultaneously use the housing B bottom pin hole.

With auto switch compatibility (Option)

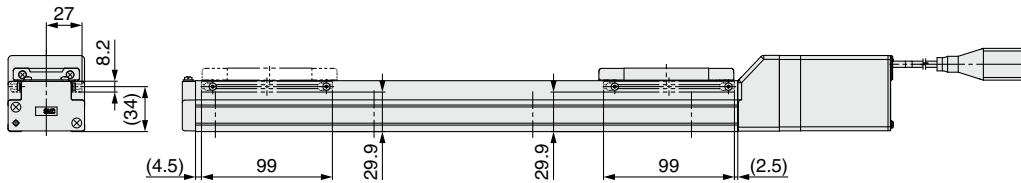

\* For strokes of 99 mm or less, only 2 auto switch mounting brackets can be installed on the motor side.

Dimensions		[mm]
Model	G	H
LEFS25G□-50□	100	30
LEFS25G□-100□		
LEFS25G□-150□		
LEFS25G□-200□	220	45
LEFS25G□-250□		
LEFS25G□-300□	340	45
LEFS25G□-400□		
LEFS25G□-450□	460	45
LEFS25G□-500□		
LEFS25G□-550□	580	45
LEFS25G□-600□		
LEFS25G□-650□	700	45
LEFS25G□-700□		
LEFS25G□-750□	820	45
LEFS25G□-800□		

## Dimensions: In-line Motor

### LEFS32G

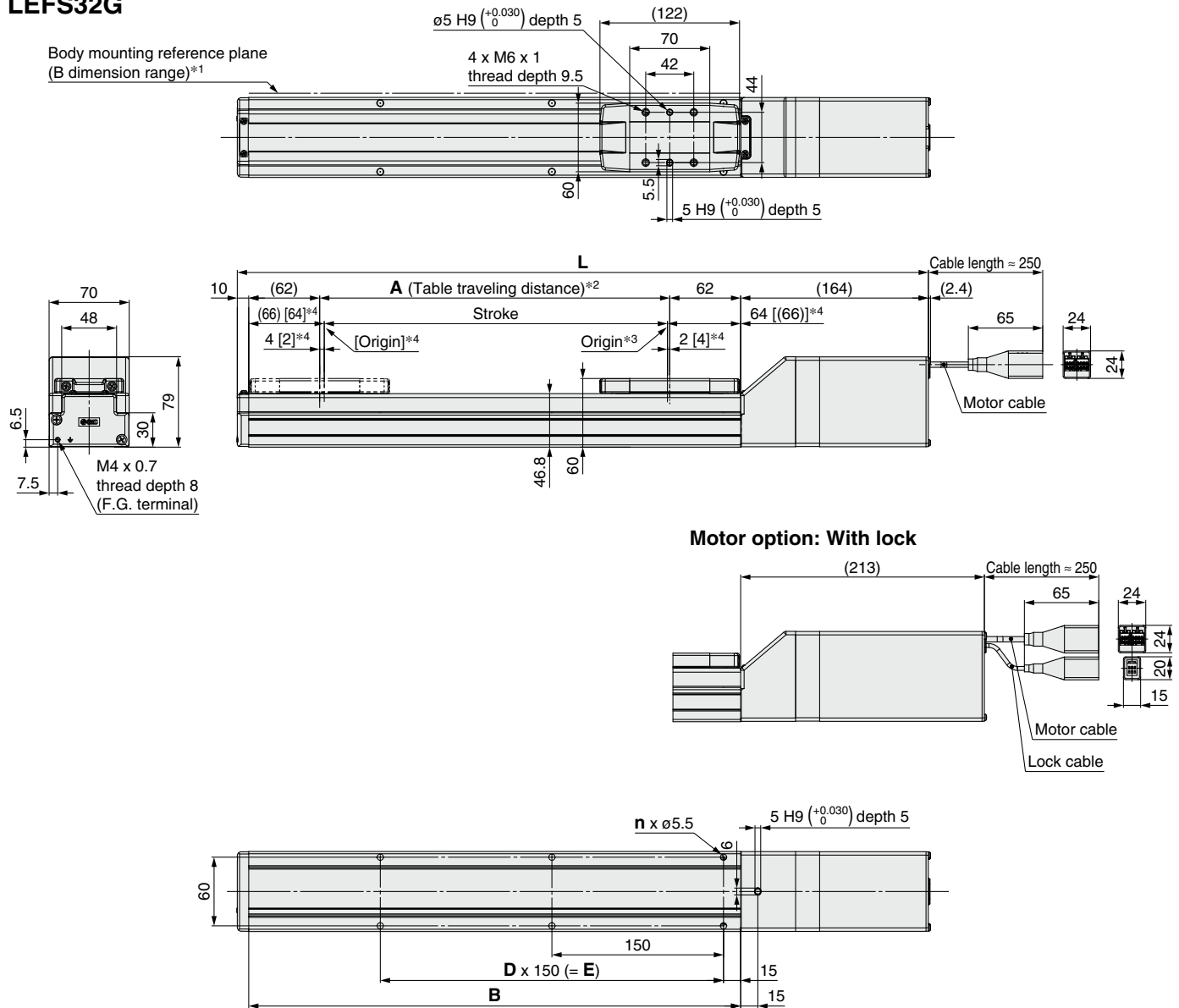

- \*1 When mounting the actuator using the body mounting reference plane, set the height of the opposite surface or pin to be 3 mm or more. (Recommended height: 5 mm)  
In addition, be aware that surfaces other than the body mounting reference plane (B dimension range) may slightly protrude from the body mounting reference plane. Be sure to provide a clearance of 1 mm or more to avoid interference with workpieces, facilities, etc.
- \*2 This is the distance within which the table can move when it returns to origin.  
Make sure that workpieces mounted on the table do not interfere with other workpieces or the facilities around the table.
- \*3 Position after returning to origin
- \*4 [ ] for when the direction of return to origin has changed

### Dimensions

Model	L		A	B	n	D	E
	Without lock	With lock					
LEFS32G□-50□	354	403	56	180	4	—	—
LEFS32G□-100□	404	453	106	230			
LEFS32G□-150□	454	503	156	280			
LEFS32G□-200□	504	553	206	330	6	2	300
LEFS32G□-250□	554	603	256	380			
LEFS32G□-300□	604	653	306	430			
LEFS32G□-350□	654	703	356	480	8	3	450
LEFS32G□-400□	704	753	406	530			
LEFS32G□-450□	754	803	456	580			
LEFS32G□-500□	804	853	506	630	10	4	600
LEFS32G□-550□	854	903	556	680			
LEFS32G□-600□	904	953	606	730			
LEFS32G□-650□	954	1003	656	780	12	5	750
LEFS32G□-700□	1004	1053	706	830			
LEFS32G□-750□	1054	1103	756	880			
LEFS32G□-800□	1104	1153	806	930	14	6	900
LEFS32G□-850□	1154	1203	856	980			
LEFS32G□-900□	1204	1253	906	1030			
LEFS32G□-950□	1254	1303	956	1080	16	7	1050
LEFS32G□-1000□	1304	1353	1006	1130			

## Dimensions: In-line Motor

### LEFS32G

Positioning pin hole\*1 (Option): Body bottom

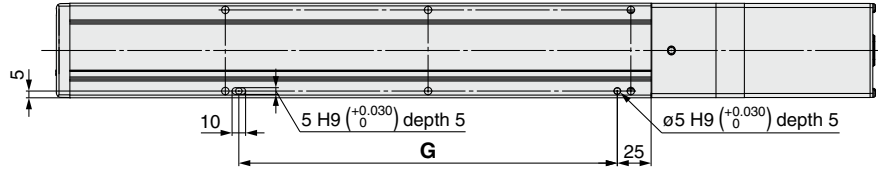

\*1 When using the body bottom positioning pin holes, do not simultaneously use the housing B bottom pin hole.

With auto switch compatibility (Option)

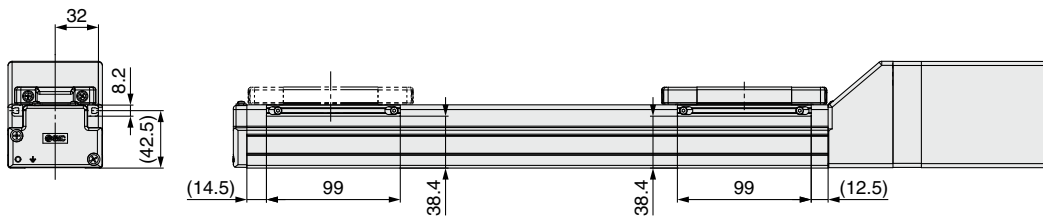

\* For strokes of 99 mm or less, only 2 auto switch mounting brackets can be installed on the motor side.

Dimensions [mm]	
Model	G
LEFS32G□-50□	130
LEFS32G□-100□	
LEFS32G□-150□	
LEFS32G□-200□	280
LEFS32G□-250□	
LEFS32G□-300□	
LEFS32G□-350□	430
LEFS32G□-400□	
LEFS32G□-450□	
LEFS32G□-500□	580
LEFS32G□-550□	
LEFS32G□-600□	
LEFS32G□-650□	730
LEFS32G□-700□	
LEFS32G□-750□	
LEFS32G□-800□	880
LEFS32G□-850□	
LEFS32G□-900□	
LEFS32G□-950□	1030
LEFS32G□-1000□	

## Dimensions: In-line Motor

### LEFS40G

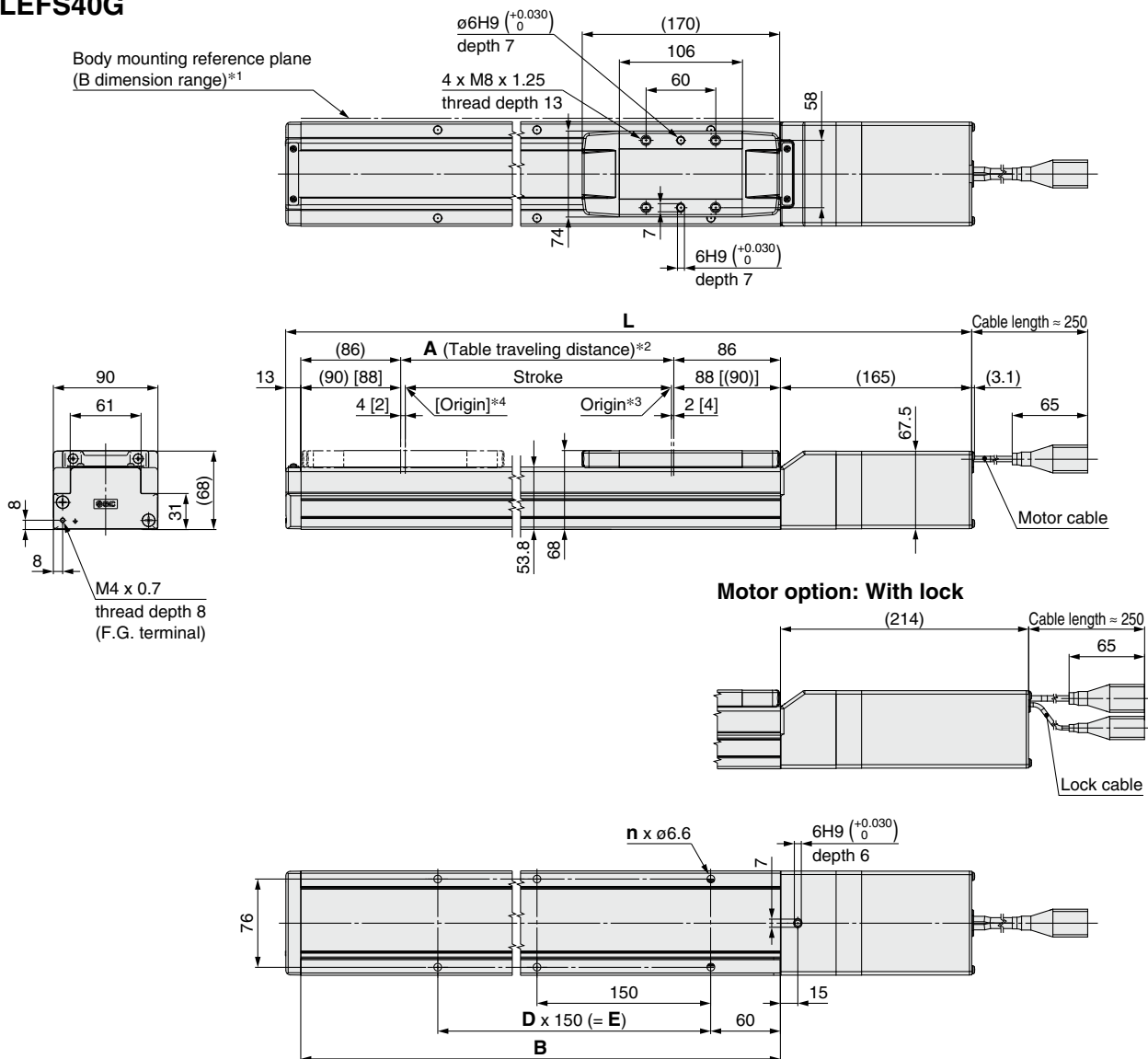

\*1 When mounting the actuator using the body mounting reference plane, set the height of the opposite surface or pin to be 3 mm or more because of round chamfering. (Recommended height: 5 mm)  
In addition, be aware that surfaces other than the body mounting reference plane (B dimension range) may slightly protrude from the body mounting reference plane. Be sure to provide a clearance of 1 mm or more to avoid interference with workpieces, facilities, etc.

\*2 This is the distance within which the table can move when it returns to origin.  
Make sure that workpieces mounted on the table do not interfere with other workpieces or the facilities around the table.

\*3 Position after returning to origin

\*4 [ ] for when the direction of return to origin has changed

### Dimensions

Model	L		A	B	n	D	E
	Without lock	With lock					
LEFS40G□-150□	506	555	156	328	4	—	150
LEFS40G□-200□	556	605	206	378	—	—	—
LEFS40G□-250□	606	655	256	428	6	2	300
LEFS40G□-300□	656	705	306	478	—	—	—
LEFS40G□-350□	706	755	356	528	—	—	—
LEFS40G□-400□	756	805	406	578	8	3	450
LEFS40G□-450□	806	855	456	628	—	—	—
LEFS40G□-500□	856	905	506	678	—	—	—
LEFS40G□-550□	906	955	556	728	10	4	600
LEFS40G□-600□	956	1005	606	778	—	—	—
LEFS40G□-650□	1006	1055	656	828	—	—	—
LEFS40G□-700□	1056	1105	706	878	12	5	750
LEFS40G□-750□	1106	1155	756	928	—	—	—
LEFS40G□-800□	1156	1205	806	978	—	—	—
LEFS40G□-850□	1206	1255	856	1028	14	6	900
LEFS40G□-900□	1256	1305	906	1078	—	—	—
LEFS40G□-950□	1306	1355	956	1128	16	7	1050
LEFS40G□-1000□	1356	1405	1006	1178	—	—	—
LEFS40G□-1100□	1456	1505	1106	1278	18	8	1200
LEFS40G□-1200□	1556	1605	1206	1378	—	—	—

## Dimensions: In-line Motor

### LEFS40G

Positioning pin hole\*1 (Option): Body bottom

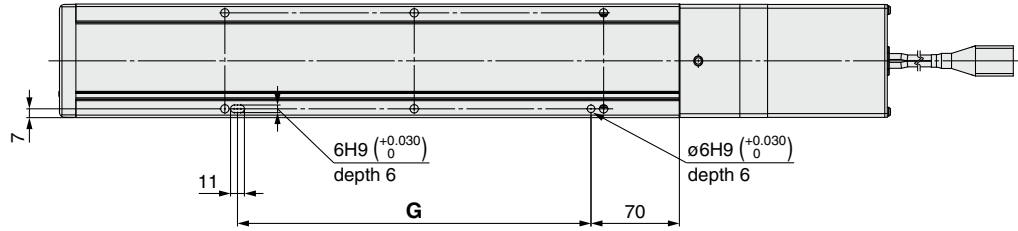

\*1 When using the body bottom positioning pin holes, do not simultaneously use the housing B bottom pin hole.

With auto switch compatibility (Option)

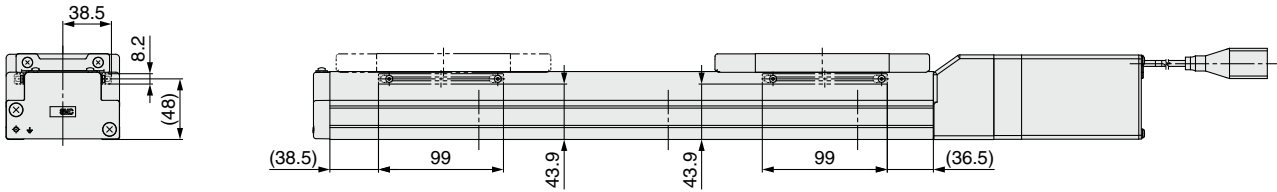

Dimensions [mm]	
Model	G
LEFS40G□-150□	130
LEFS40G□-200□	280
LEFS40G□-250□	
LEFS40G□-300□	430
LEFS40G□-350□	
LEFS40G□-400□	
LEFS40G□-450□	580
LEFS40G□-500□	
LEFS40G□-550□	
LEFS40G□-600□	730
LEFS40G□-650□	
LEFS40G□-700□	
LEFS40G□-750□	880
LEFS40G□-800□	
LEFS40G□-850□	
LEFS40G□-900□	1030
LEFS40G□-950□	
LEFS40G□-1000□	
LEFS40G□-1100□	1180
LEFS40G□-1200□	

Model Selection

LEFS□G Series

Auto Switch

JXC5H/6H Series

JXCEH/9H/PH Series

## Dimensions: Motor Parallel

### LEFS16RG

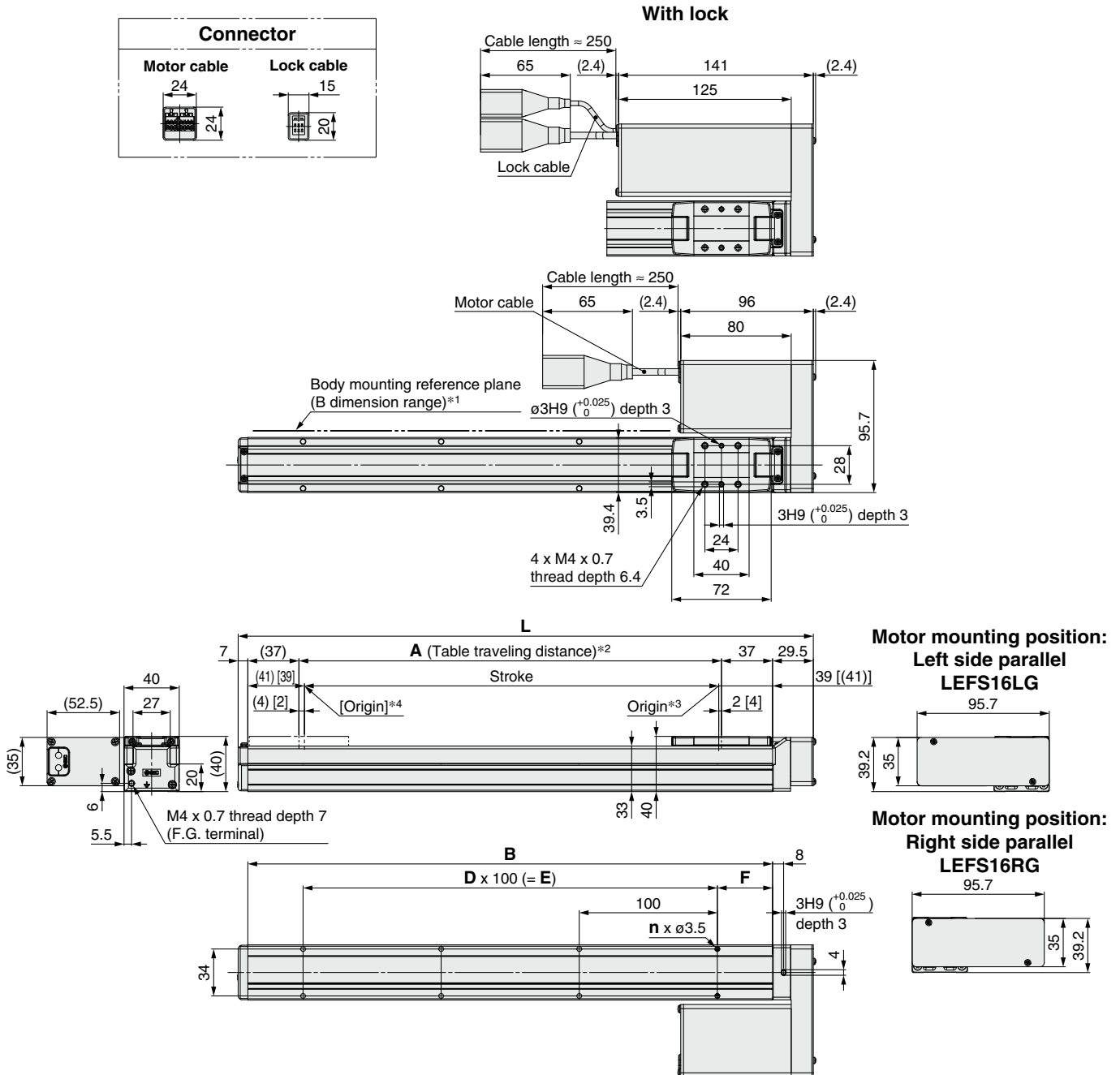

\*1 When mounting the actuator using the body mounting reference plane, set the height of the opposite surface or pin to be 2 mm or more because of round chamfering. (Recommended height: 5 mm)  
In addition, be aware that surfaces other than the body mounting reference plane (B dimension range) may slightly protrude from the body mounting reference plane. Be sure to provide a clearance of 1 mm or more to avoid interference with workpieces, facilities, etc.

\*2 This is the distance within which the table can move when it returns to origin.  
Make sure that workpieces mounted on the table do not interfere with other workpieces or the facilities around the table.

\*3 Position after returning to origin

\*4 [ ] for when the direction of return to origin has changed

### Dimensions

Model	L	A	B	n	D	E	F
LEFS16□G□-50□	166.5	56	130	4	—	—	15
LEFS16□G□-100□	216.5	106	180				
LEFS16□G□-150□	266.5	156	230				
LEFS16□G□-200□	316.5	206	280	6	2	200	40
LEFS16□G□-250□	366.5	256	330				
LEFS16□G□-300□	416.5	306	380	8	3	300	
LEFS16□G□-350□	466.5	356	430				
LEFS16□G□-400□	516.5	406	480				
LEFS16□G□-450□	566.5	456	530	10	4	400	
LEFS16□G□-500□	616.5	506	580				12

## Dimensions: Motor Parallel

### LEFS16RG

Positioning pin hole\*1 (Option): Body bottom

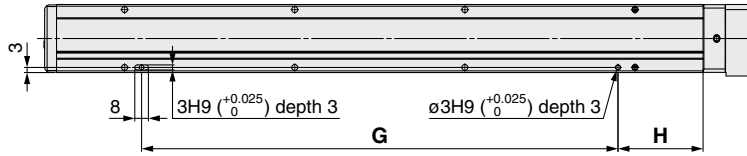

\*1 When using the body bottom positioning pin holes, do not simultaneously use the housing B bottom pin hole.

### Dimensions

Model	Positioning pin hole: <b>K</b>	
	<b>G</b>	<b>H</b>
LEFS16□G□-50□	80	25
LEFS16□G□-100□		50
LEFS16□G□-150□		
LEFS16□G□-200□		
LEFS16□G□-250□		
LEFS16□G□-300□		
LEFS16□G□-350□		
LEFS16□G□-400□		
LEFS16□G□-450□		
LEFS16□G□-500□	480	

## Dimensions: Motor Parallel

### LEFS25RG

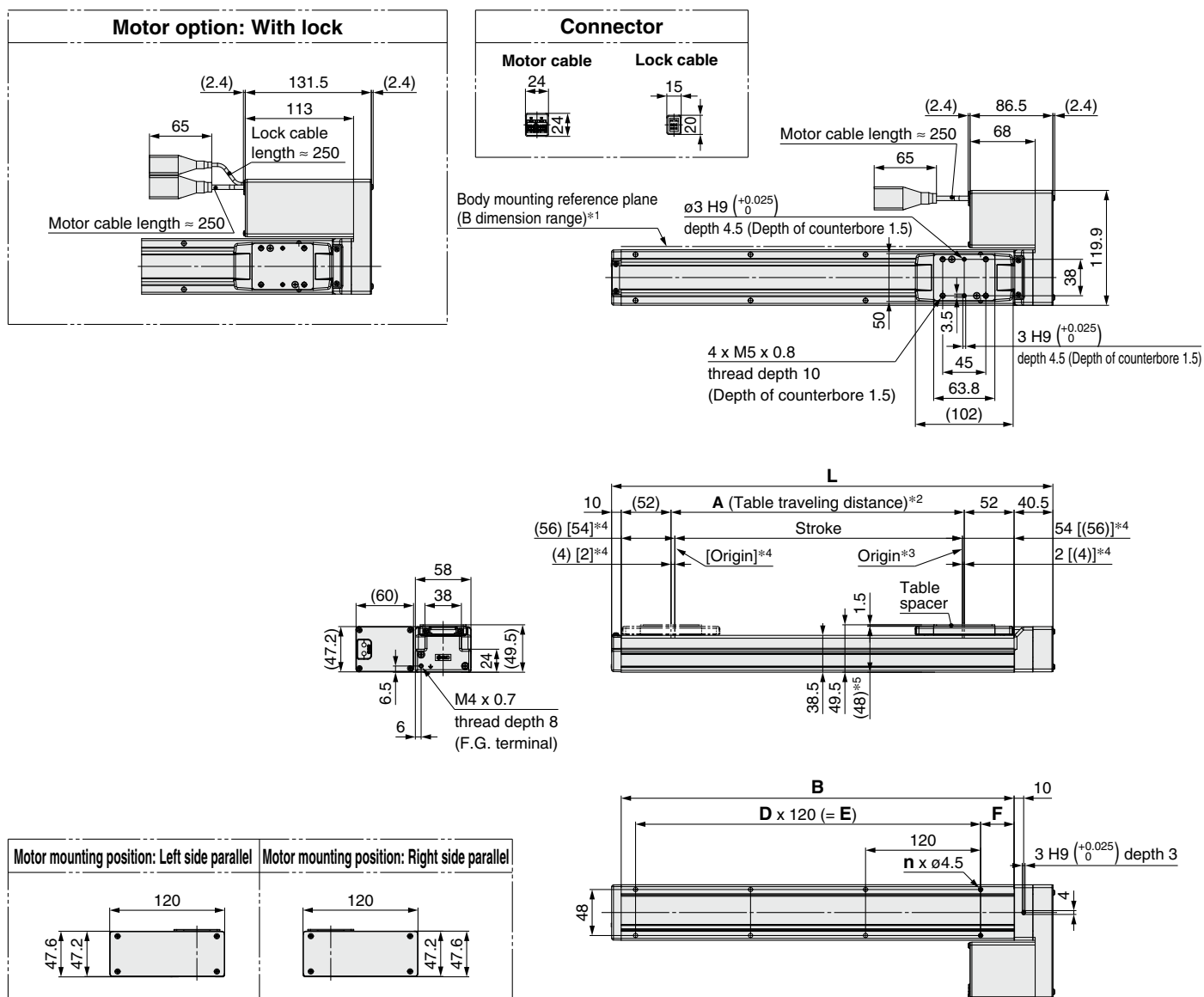

- \*1 When mounting the actuator using the body mounting reference plane, set the height of the opposite surface or pin to be 3 mm or more. (Recommended height: 5 mm)  
In addition, be aware that surfaces other than the body mounting reference plane (B dimension range) may slightly protrude from the body mounting reference plane. Be sure to provide a clearance of 1 mm or more to avoid interference with workpieces, facilities, etc.
- \*2 This is the distance within which the table can move when it returns to origin.  
Make sure that workpieces mounted on the table do not interfere with other workpieces or the facilities around the table.
- \*3 Position after returning to origin
- \*4 [ ] for when the direction of return to origin has changed
- \*5 When the table spacer is removed

Model	L	A	B	n	D	E	F
LEFS25□G□-50□	210.5	56	160	4	—	—	20
LEFS25□G□-100□	260.5	106	210				20
LEFS25□G□-150□	310.5	156	260				20
LEFS25□G□-200□	360.5	206	310	6	2	240	35
LEFS25□G□-250□	410.5	256	360				
LEFS25□G□-300□	460.5	306	410	8	3	360	35
LEFS25□G□-350□	510.5	356	460				
LEFS25□G□-400□	560.5	406	510				

Model	L	A	B	n	D	E	F
LEFS25□G□-450□	610.5	456	560	10	4	480	35
LEFS25□G□-500□	660.5	506	610				
LEFS25□G□-550□	710.5	556	660	12	5	600	35
LEFS25□G□-600□	760.5	606	710				
LEFS25□G□-650□	810.5	656	760				
LEFS25□G□-700□	860.5	706	810	14	6	720	35
LEFS25□G□-750□	910.5	756	860				
LEFS25□G□-800□	960.5	806	910	16	7	840	35



## Dimensions: Motor Parallel

### LEFS25RG

Positioning pin hole\*1 (Option): Body bottom

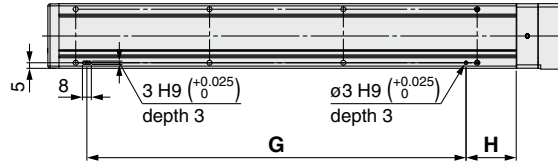

\*1 When using the body bottom positioning pin holes, do not simultaneously use the housing B bottom pin hole.

Model	[mm]	
	G	H
LEFS25□G□-50□	100	30
LEFS25□G□-100□		
LEFS25□G□-150□		
LEFS25□G□-200□	220	45
LEFS25□G□-250□		
LEFS25□G□-300□		
LEFS25□G□-350□		
LEFS25□G□-400□		
LEFS25□G□-450□		
LEFS25□G□-500□		
LEFS25□G□-550□		
LEFS25□G□-600□		
LEFS25□G□-650□	700	
LEFS25□G□-700□		
LEFS25□G□-750□		
LEFS25□G□-800□	820	

Model Selection

LEFS□G Series

Auto Switch

JXC5H/6H Series

JXCEH/9H/PH Series

## Dimensions: Motor Parallel

### LEFS32RG

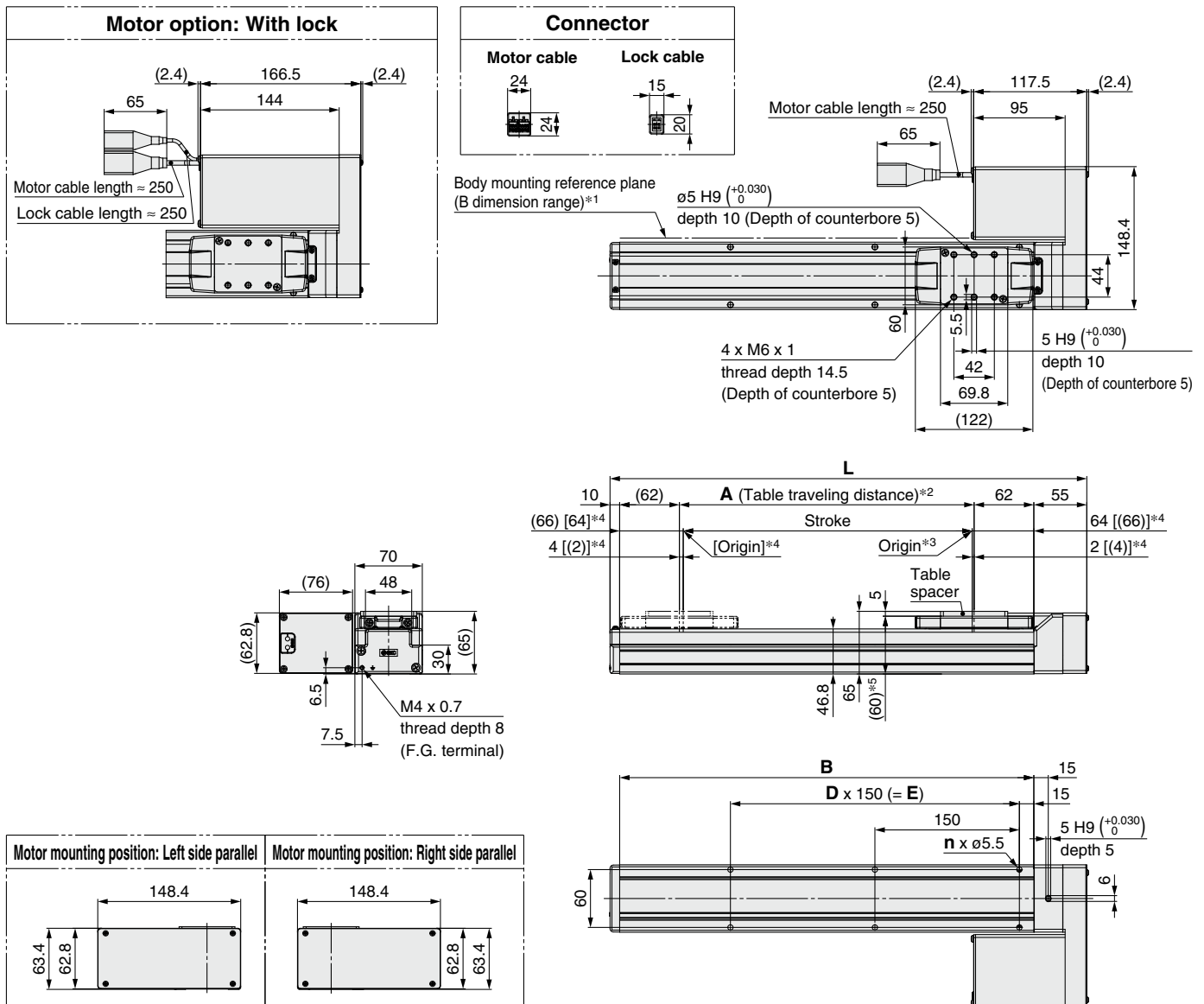

\*1 When mounting the actuator using the body mounting reference plane, set the height of the opposite surface or pin to be 3 mm or more. (Recommended height: 5 mm)

In addition, be aware that surfaces other than the body mounting reference plane (B dimension range) may slightly protrude from the body mounting reference plane. Be sure to provide a clearance of 1 mm or more to avoid interference with workpieces, facilities, etc.

\*2 This is the distance within which the table can move when it returns to origin.

Make sure that workpieces mounted on the table do not interfere with other workpieces or the facilities around the table.

\*3 Position after returning to origin

\*4 [ ] for when the direction of return to origin has changed

\*5 When the table spacer is removed

### Dimensions

Model	L	A	B	n	D	E
LEFS32□G□-50□	245	56	180	4	—	—
LEFS32□G□-100□	295	106	230			
LEFS32□G□-150□	345	156	280			
LEFS32□G□-200□	395	206	330			
LEFS32□G□-250□	445	256	380	6	2	300
LEFS32□G□-300□	495	306	430	8	3	450
LEFS32□G□-350□	545	356	480			
LEFS32□G□-400□	595	406	530			
LEFS32□G□-450□	645	456	580			
LEFS32□G□-500□	695	506	630			
LEFS32□G□-550□	745	556	680			

### Dimensions

Model	L	A	B	n	D	E
LEFS32□G□-550□	745	556	680	10	4	600
LEFS32□G□-600□	795	606	730			
LEFS32□G□-650□	845	656	780			
LEFS32□G□-700□	895	706	830	12	5	750
LEFS32□G□-750□	945	756	880			
LEFS32□G□-800□	995	806	930			
LEFS32□G□-850□	1045	856	980	14	6	900
LEFS32□G□-900□	1095	906	1030			
LEFS32□G□-950□	1145	956	1080			
LEFS32□G□-1000□	1195	1006	1130	16	7	1050

## Dimensions: Motor Parallel

### LEFS32RG

Positioning pin hole\*1 (Option): Body bottom

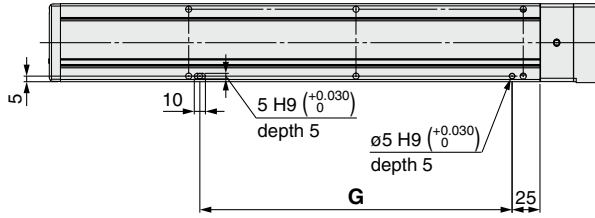

\*1 When using the body bottom positioning pin holes, do not simultaneously use the housing B bottom pin hole.

Dimensions [mm]	
Model	G
LEFS32□G□-50□	130
LEFS32□G□-100□	
LEFS32□G□-150□	
LEFS32□G□-200□	
LEFS32□G□-250□	280
LEFS32□G□-300□	
LEFS32□G□-350□	
LEFS32□G□-400□	430
LEFS32□G□-450□	
LEFS32□G□-500□	
LEFS32□G□-550□	580
LEFS32□G□-600□	
LEFS32□G□-650□	
LEFS32□G□-700□	730
LEFS32□G□-750□	
LEFS32□G□-800□	
LEFS32□G□-850□	880
LEFS32□G□-900□	
LEFS32□G□-950□	
LEFS32□G□-1000□	1030

## Dimensions: Motor Parallel

### LEFS40RG

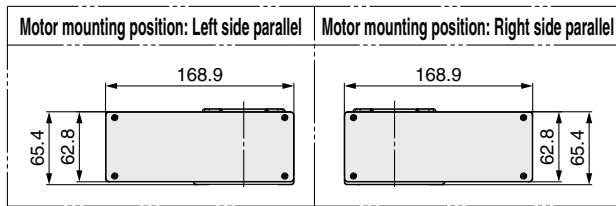
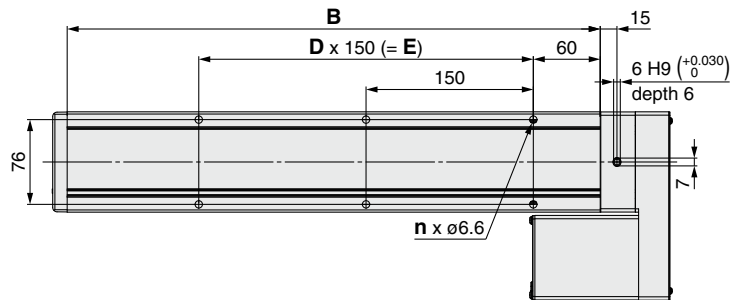
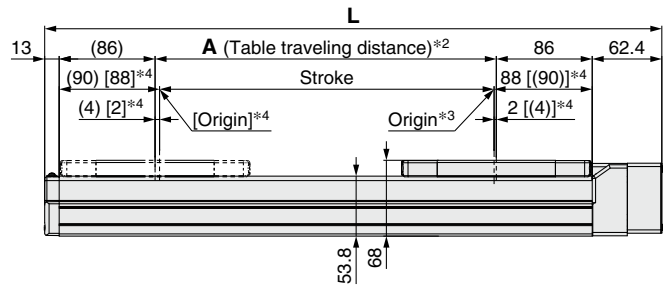
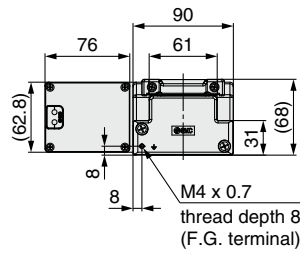
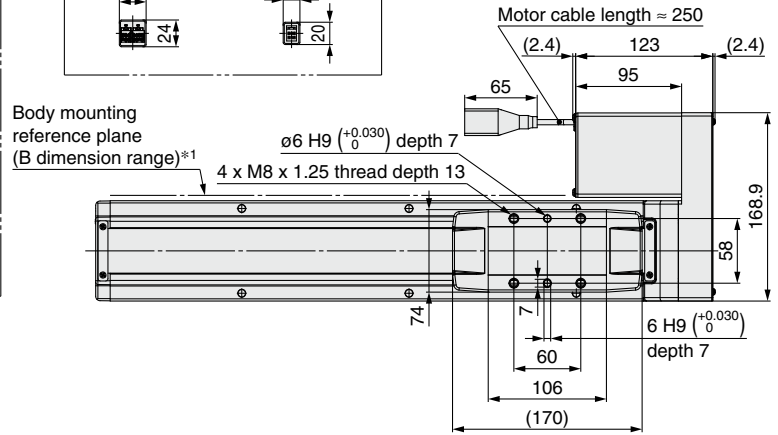
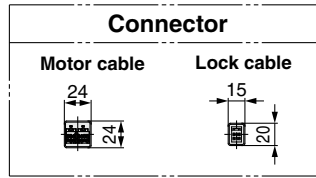
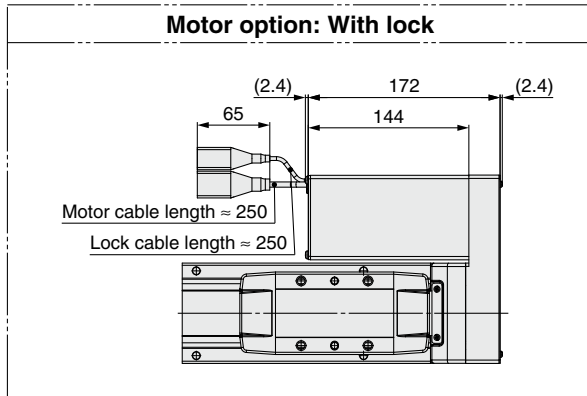

- \*1 When mounting the actuator using the body mounting reference plane, set the height of the opposite surface or pin to be 3 mm or more. (Recommended height: 5 mm)  
In addition, be aware that surfaces other than the body mounting reference plane (B dimension range) may slightly protrude from the body mounting reference plane. Be sure to provide a clearance of 1 mm or more to avoid interference with workpieces, facilities, etc.
- \*2 This is the distance within which the table can move when it returns to origin.  
Make sure that workpieces mounted on the table do not interfere with other workpieces or the facilities around the table.
- \*3 Position after returning to origin
- \*4 [ ] for when the direction of return to origin has changed

Model	L	A	B	n	D	E
LEFS40□G□-150□	403.4	156	328	4	—	—
LEFS40□G□-200□	453.4	206	378	6	2	300
LEFS40□G□-250□	503.4	256	428			
LEFS40□G□-300□	553.4	306	478	8	3	450
LEFS40□G□-350□	603.4	356	528			
LEFS40□G□-400□	653.4	406	578	10	4	600
LEFS40□G□-450□	703.4	456	628			
LEFS40□G□-500□	753.4	506	678			
LEFS40□G□-550□	803.4	556	728			
LEFS40□G□-600□	853.4	606	778			

Model	L	A	B	n	D	E
LEFS40□G□-650□	903.4	656	828	12	5	750
LEFS40□G□-700□	953.4	706	878			
LEFS40□G□-750□	1003.4	756	928	14	6	900
LEFS40□G□-800□	1053.4	806	978			
LEFS40□G□-850□	1103.4	856	1028	16	7	1050
LEFS40□G□-900□	1153.4	906	1078			
LEFS40□G□-950□	1203.4	956	1128	18	8	1200
LEFS40□G□-1000□	1253.4	1006	1178			
LEFS40□G□-1100□	1353.4	1106	1278			
LEFS40□G□-1200□	1453.4	1206	1378			

## Dimensions: Motor Parallel

### LEFS40RG

Positioning pin hole\*1 (Option): Body bottom

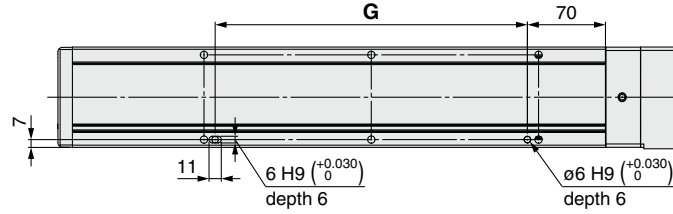

\*1 When using the body bottom positioning pin holes, do not simultaneously use the housing B bottom pin hole.

Dimensions [mm]	
Model	G
LEFS40□G□-150□	130
LEFS40□G□-200□	
LEFS40□G□-250□	280
LEFS40□G□-300□	
LEFS40□G□-350□	
LEFS40□G□-400□	430
LEFS40□G□-450□	
LEFS40□G□-500□	
LEFS40□G□-550□	580
LEFS40□G□-600□	
LEFS40□G□-650□	
LEFS40□G□-700□	730
LEFS40□G□-750□	
LEFS40□G□-800□	
LEFS40□G□-850□	880
LEFS40□G□-900□	
LEFS40□G□-950□	
LEFS40□G□-1000□	1030
LEFS40□G□-1100□	
LEFS40□G□-1200□	1180

# LEFS□G Series Auto Switch Mounting

## Auto Switch Mounting Position

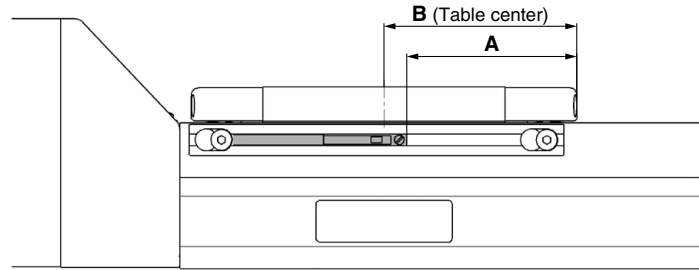

[mm]				
Model	Size	A	B	Operating range
LEFS□G	25	45	51	4.9
	32	55	61	3.9
	40	79	85	5.3

- \* The applicable auto switch is D-M9 (N/P/B) (W) (M/L/Z).
- \* The operating range is a guideline including hysteresis, not meant to be guaranteed. There may be large variations depending on the ambient environment.
- \* Adjust the auto switch after confirming the operating conditions in the actual setting.

## Auto Switch Mounting

Rotate the bolts for the auto switch mounting bracket three to four times to loosen them (Removing them is not required), and slide and remove the auto switch mounting bracket. Then, insert a switch into the groove on the mounting bracket.

As the mounting bolts for installing the product body interfere with the auto switch mounting bracket, mount the auto switch mounting bracket after installing the product body. After setting in the mounting position, use a flat head watchmaker's screwdriver to tighten the auto switch mounting screw that is included.

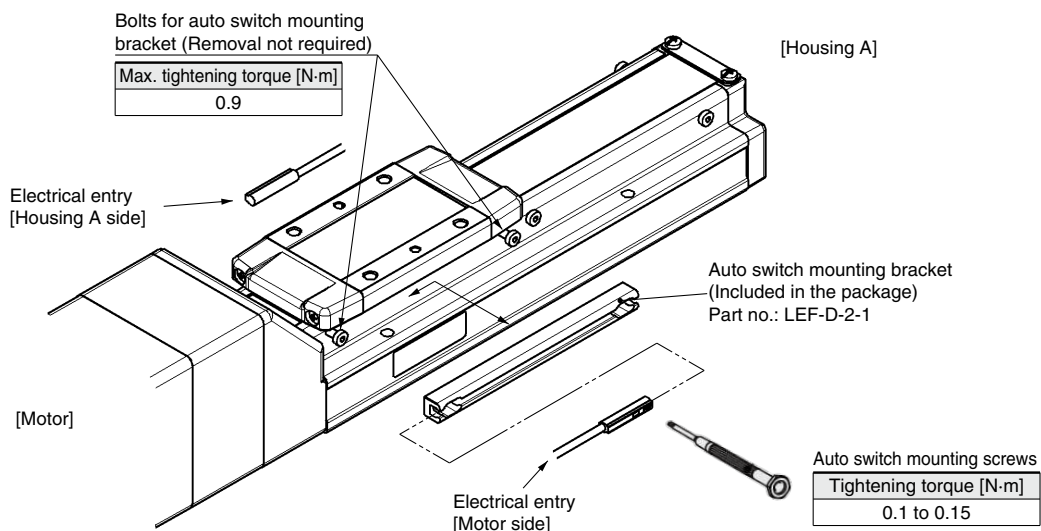

- \* The applicable auto switch is D-M9 (N/P/B) (W) (M/L/Z).
- \* The direction of the lead wire entry is specified. If it is mounted in the opposite direction, the auto switch may malfunction.
- \* When tightening the auto switch mounting screw (included with the auto switch), use a watchmaker's screwdriver with a handle diameter of about 5 to 6 mm.
- \* If more than two auto switch mounting brackets are required, please order them separately. All eight bolts for attaching the auto switch mounting bracket at the stroke end are tightened into the body when the product is shipped.  
For 50-mm stroke type, only four bolts are tightened on the motor side.

# Solid State Auto Switch Direct Mounting Type D-M9N/D-M9P/D-M9B



Refer to the SMC website for details on products that are compliant with international standards.

## Grommet

- 2-wire load current is reduced (2.5 to 40 mA).
- Using flexible cable as standard spec.



## Caution

### Precautions

Fix the auto switch with the existing screw installed on the auto switch body. The auto switch may be damaged if a screw other than the one supplied is used.

## Auto Switch Specifications

PLC: Programmable Logic Controller

D-M9□, D-M9□V (With indicator light)			
Auto switch model	D-M9N	D-M9P	D-M9B
Electrical entry direction	In-line		
Wiring type	3-wire		2-wire
Output type	NPN	PNP	—
Applicable load	IC circuit, Relay, PLC		24 VDC relay, PLC
Power supply voltage	5, 12, 24 VDC (4.5 to 28 V)		—
Current consumption	10 mA or less		—
Load voltage	28 VDC or less	—	24 VDC (10 to 28 VDC)
Load current	40 mA or less		2.5 to 40 mA
Internal voltage drop	0.8 V or less at 10 mA (2 V or less at 40 mA)		4 V or less
Leakage current	100 μA or less at 24 VDC		0.8 mA or less
Indicator light	Red LED illuminates when turned ON.		
Standard	CE marking, RoHS		

## Oilproof Flexible Heavy-duty Lead Wire Specifications

Auto switch model		D-M9N	D-M9P	D-M9B
Sheath	Outside diameter [mm]	2.6		
Insulator	Number of cores	3 cores (Brown/Blue/Black)		2 cores (Brown/Blue)
	Outside diameter [mm]	0.88		
Conductor	Effective area [mm <sup>2</sup> ]	0.15		
	Strand diameter [mm]	0.05		
Minimum bending radius [mm] (Reference values)		17		

- \* Refer to the **Web Catalog** for solid state auto switch common specifications.
- \* Refer to the **Web Catalog** for lead wire lengths.

## Weight

[g]

Auto switch model		D-M9N	D-M9P	D-M9B
Lead wire length	0.5 m (Nil)	8	7	7
	1 m (M)	14	13	13
	3 m (L)	41	38	38
	5 m (Z)	68	63	63

## Dimensions

[mm]

### D-M9□

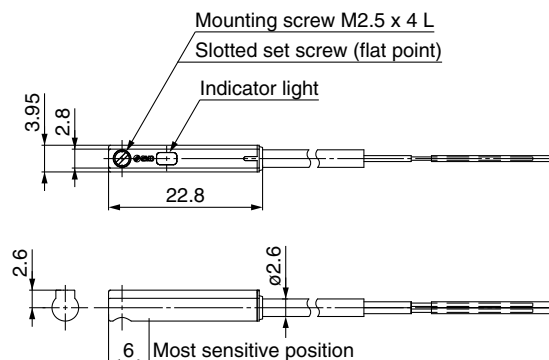

Model Selection

LEFS□G Series

Auto Switch

JXC5H/6H Series

JXCEH/9H/PH Series

# Normally Closed Solid State Auto Switch Direct Mounting Type

## D-M9NE(V)/D-M9PE(V)/D-M9BE(V)



Refer to the SMC website for details on products that are compliant with international standards.

### Auto Switch Specifications

PLC: Programmable Logic Controller

D-M9□E, D-M9□EV (With indicator light)						
Auto switch model	D-M9NE	D-M9NEV	D-M9PE	D-M9PEV	D-M9BE	D-M9BEV
Electrical entry direction	In-line	Perpendicular	In-line	Perpendicular	In-line	Perpendicular
Wiring type	3-wire				2-wire	
Output type	NPN		PNP		—	
Applicable load	IC circuit, Relay, PLC				24 VDC relay, PLC	
Power supply voltage	5, 12, 24 VDC (4.5 to 28 V)				—	
Current consumption	10 mA or less				—	
Load voltage	28 VDC or less		—		24 VDC (10 to 28 VDC)	
Load current	40 mA or less				2.5 to 40 mA	
Internal voltage drop	0.8 V or less at 10 mA (2 V or less at 40 mA)				4 V or less	
Leakage current	100 μA or less at 24 VDC				0.8 mA or less	
Indicator light	Red LED illuminates when turned ON.					
Standard	CE marking, RoHS					

### Grommet

- Output signal turns on when no magnetic force is detected.
- Can be used for the actuator adopted by the solid state auto switch D-M9 series (excluding special order products)



### Oilproof Flexible Heavy-duty Lead Wire Specifications

Auto switch model		D-M9NE(V)	D-M9PE(V)	D-M9BE(V)
Sheath	Outside diameter [mm]	2.6		
Insulator	Number of cores	3 cores (Brown/Blue/Black)		2 cores (Brown/Blue)
	Outside diameter [mm]	0.88		
Conductor	Effective area [mm <sup>2</sup> ]	0.15		
	Strand diameter [mm]	0.05		
Minimum bending radius [mm] (Reference values)		17		

- \* Refer to the **Web Catalog** for solid state auto switch common specifications.
- \* Refer to the **Web Catalog** for lead wire lengths.

### Caution

#### Precautions

Fix the auto switch with the existing screw installed on the auto switch body. The auto switch may be damaged if a screw other than the one supplied is used.

### Weight

[g]

Auto switch model		D-M9NE(V)	D-M9PE(V)	D-M9BE(V)
Lead wire length	0.5 m (Nil)	8	7	7
	1 m (M)*1	14	13	13
	3 m (L)	41	38	38
	5 m (Z)*1	68	63	63

\*1 The 1 m and 5 m options are produced upon receipt of order.

### Dimensions

[mm]

#### D-M9□E

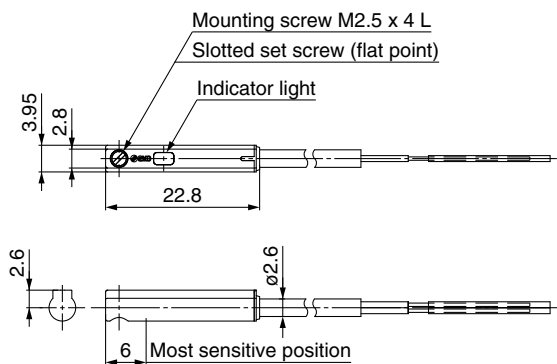

#### D-M9□EV

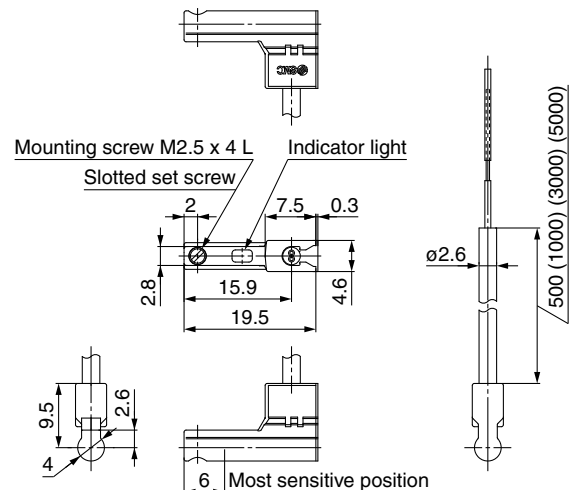



# 2-Color Indicator Solid State Auto Switch Direct Mounting Type D-M9NW/D-M9PW/D-M9BW



Refer to the SMC website for details on products that are compliant with international standards.

## Grommet

- 2-wire load current is reduced (2.5 to 40 mA).
- Using flexible cable as standard spec.
- The proper operating range can be determined by the color of the light. (Red → Green ← Red)



## Caution

### Precautions

Fix the auto switch with the existing screw installed on the auto switch body. The auto switch may be damaged if a screw other than the one supplied is used.

## Auto Switch Specifications

PLC: Programmable Logic Controller

D-M9□W, D-M9□WV (With indicator light)			
Auto switch model	D-M9NW	D-M9PW	D-M9BW
Electrical entry direction	In-line		
Wiring type	3-wire		2-wire
Output type	NPN	PNP	—
Applicable load	IC circuit, Relay, PLC		24 VDC relay, PLC
Power supply voltage	5, 12, 24 VDC (4.5 to 28 V)		—
Current consumption	10 mA or less		
Load voltage	28 VDC or less	—	24 VDC (10 to 28 VDC)
Load current	40 mA or less		2.5 to 40 mA
Internal voltage drop	0.8 V or less at 10 mA (2 V or less at 40 mA)		4 V or less
Leakage current	100 μA or less at 24 VDC		0.8 mA or less
Indicator light	Operating range ..... Red LED illuminates. Proper operating range ..... Green LED illuminates.		
Standard	CE marking, RoHS		

## Oilproof Flexible Heavy-duty Lead Wire Specifications

Auto switch model		D-M9NW	D-M9PW	D-M9BW
Sheath	Outside diameter [mm]	2.6		
Insulator	Number of cores	3 cores (Brown/Blue/Black)		2 cores (Brown/Blue)
	Outside diameter [mm]	0.88		
Conductor	Effective area [mm <sup>2</sup> ]	0.15		
	Strand diameter [mm]	0.05		
Minimum bending radius [mm] (Reference values)		17		

- \* Refer to the **Web Catalog** for solid state auto switch common specifications.
- \* Refer to the **Web Catalog** for lead wire lengths.

## Weight

[g]

Auto switch model		D-M9NW	D-M9PW	D-M9BW
Lead wire length	0.5 m (Nil)	8	7	7
	1 m (M)	14	13	13
	3 m (L)	41	38	38
	5 m (Z)	68	63	63

## Dimensions

[mm]

### D-M9□W

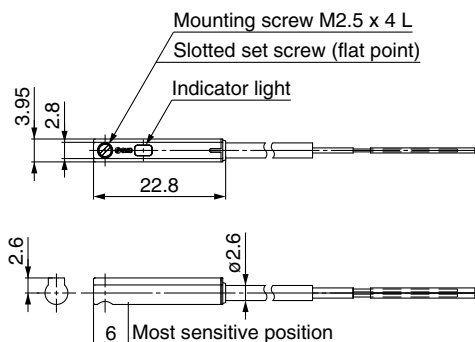



# Controllers

## JXC□ Series



Step Data Input Type ..... p. 43

### High Performance

Battery-less Absolute (Step Motor 24 VDC)

JXC5H/6H Series



EtherCAT/EtherNet/IP™/PROFINET ..... p. 50

### High Performance

Battery-less Absolute (Step Motor 24 VDC)

JXCEH/9H/PH Series

EtherCAT®

EtherNet/IP®

PROFINET®



• Actuator Cable p. 55

Model Selection

LEFS□G Series

Auto Switch

JXC5H/6H Series

JXCEH/9H/PH Series

# High Performance Controller (Step Data Input Type)

## JXC5H/6H Series



### How to Order

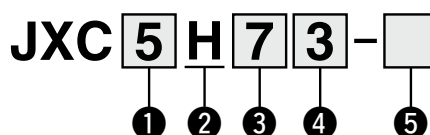

#### ① Controller type

5	Parallel I/O (NPN) type
6	Parallel I/O (PNP) type

#### ② Specification

H	High performance type
---	-----------------------

#### ③ Mounting

7	Screw mounting
8	DIN rail

#### ④ I/O cable length

Nil	None
1	1.5 m
3	3 m
5	5 m

#### ⑤ Actuator part number

Without cable specifications and actuator options Example: Enter "LEFS25GA-100" for the LEFS25GA-100B-R1□.	
BC	Blank controller*1

\*1 Requires dedicated software (JXC-BCW)

### The controller is sold as single unit after the compatible actuator is set.

Connect to an actuator (LEFS□G) designated for a high performance controller. Confirm that the combination of the controller and actuator is correct.

#### <Check the following before use.>

- Check the actuator label for the model number. This number should match that of the controller.
- Check that the Parallel I/O configuration matches (NPN or PNP).

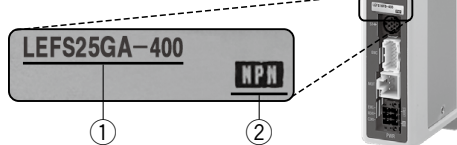

### ⚠ Caution

#### [CE/UKCA-compliant products]

EMC compliance was tested by combining the electric actuator LE series and the JXC5H/6H series.

The EMC depends on the configuration of the customer's control panel and the relationship with other electrical equipment and wiring.

Therefore, compliance with the EMC directive cannot be certified for SMC components incorporated into the customer's equipment under actual operating conditions. As a result, it is necessary for the customer to verify compliance with the EMC directive for the machinery and equipment as a whole.

\* Refer to the operation manual for using the products. Please download it via our website: <https://www.smcworld.com>

## Specifications

Model	JXC5H JXC6H
Compatible motor	Step motor (Servo/24 VDC)
Power supply	Power supply voltage: 24 VDC ±10%
Current consumption (Controller)	100 mA or less
Compatible encoder	Battery-less absolute encoder
Parallel input	11 inputs (Photo-coupler isolation)
Parallel output	13 outputs (Photo-coupler isolation)
Serial communication	RS485 (Only for the LEC-T1 and JXC-W2)
Memory	EEPROM
LED indicator	PWR, ALM
Cable length [m]	Actuator cable: 20 or less
Cooling system	Natural air cooling
Operating temperature range [°C]	0 to 40
Operating humidity range [%RH]	90 or less (No condensation)
Enclosure	IP30 (Excludes the connector)
Insulation resistance [MΩ]	Between all external terminals and the case: 50 (500 VDC)
Weight [g]	180 (Screw mounting), 200 (DIN rail mounting)

## How to Mount

### a) Screw mounting (JXC□H7□) (Installation with two M4 screws)

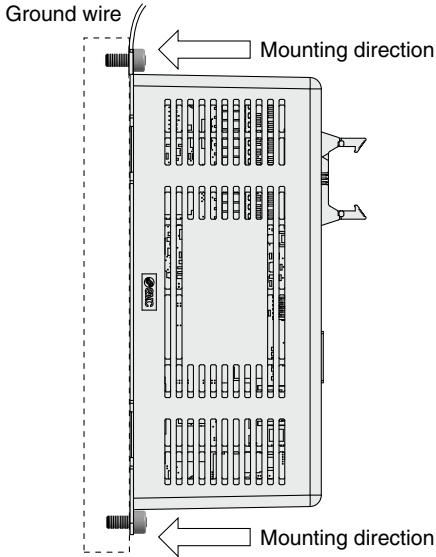

### b) DIN rail mounting (JXC□H8□) (Installation with the DIN rail)

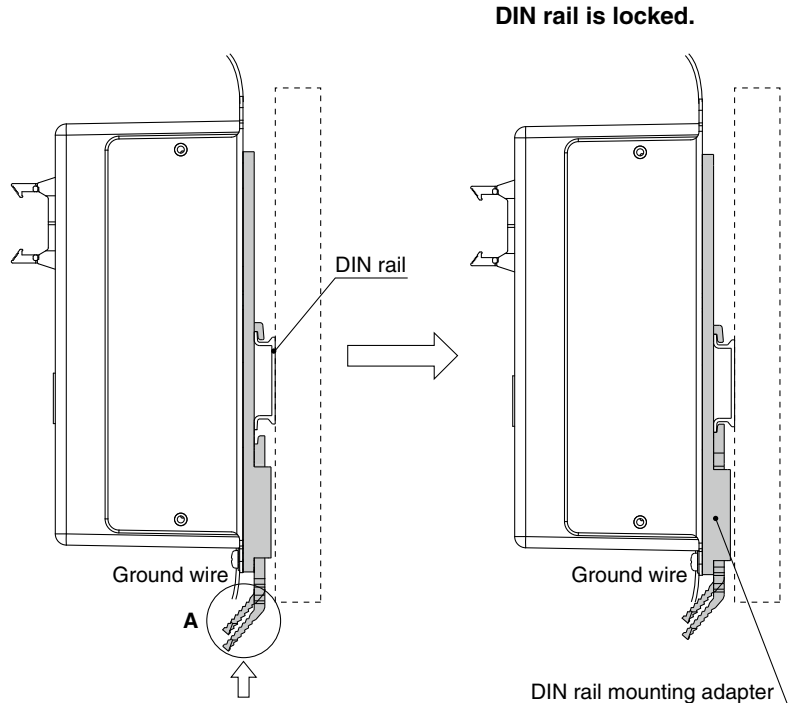

Hook the controller on the DIN rail and press the lever of section A in the arrow direction to lock it.

\* When size 25 or more of the LE series are used, the space between the controllers should be 10 mm or more.

### DIN rail AXT100-DR-□

\* For □, enter a number from the No. line in the table below.  
Refer to the dimension drawings on page 45 for the mounting dimensions.

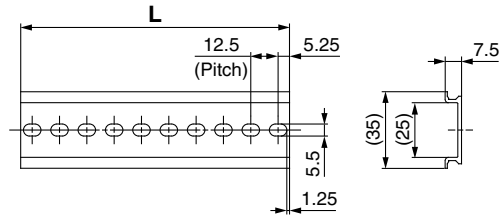

### L Dimensions [mm]

No.	1	2	3	4	5	6	7	8	9	10	11	12	13	14	15	16	17	18	19	20
L	23	35.5	48	60.5	73	85.5	98	110.5	123	135.5	148	160.5	173	185.5	198	210.5	223	235.5	248	260.5
No.	21	22	23	24	25	26	27	28	29	30	31	32	33	34	35	36	37	38	39	40
L	273	285.5	298	310.5	323	335.5	348	360.5	373	385.5	398	410.5	423	435.5	448	460.5	473	485.5	498	510.5

### DIN rail mounting adapter LEC-3-D0 (with 2 mounting screws)

This should be used when the DIN rail mounting adapter is mounted onto a screw mounting type controller afterward.

Model Selection

LEFS□G Series

Auto Switch

JXC5H/6H Series

JXCEH/9H/PH Series

# JXC5H/6H Series

## Dimensions

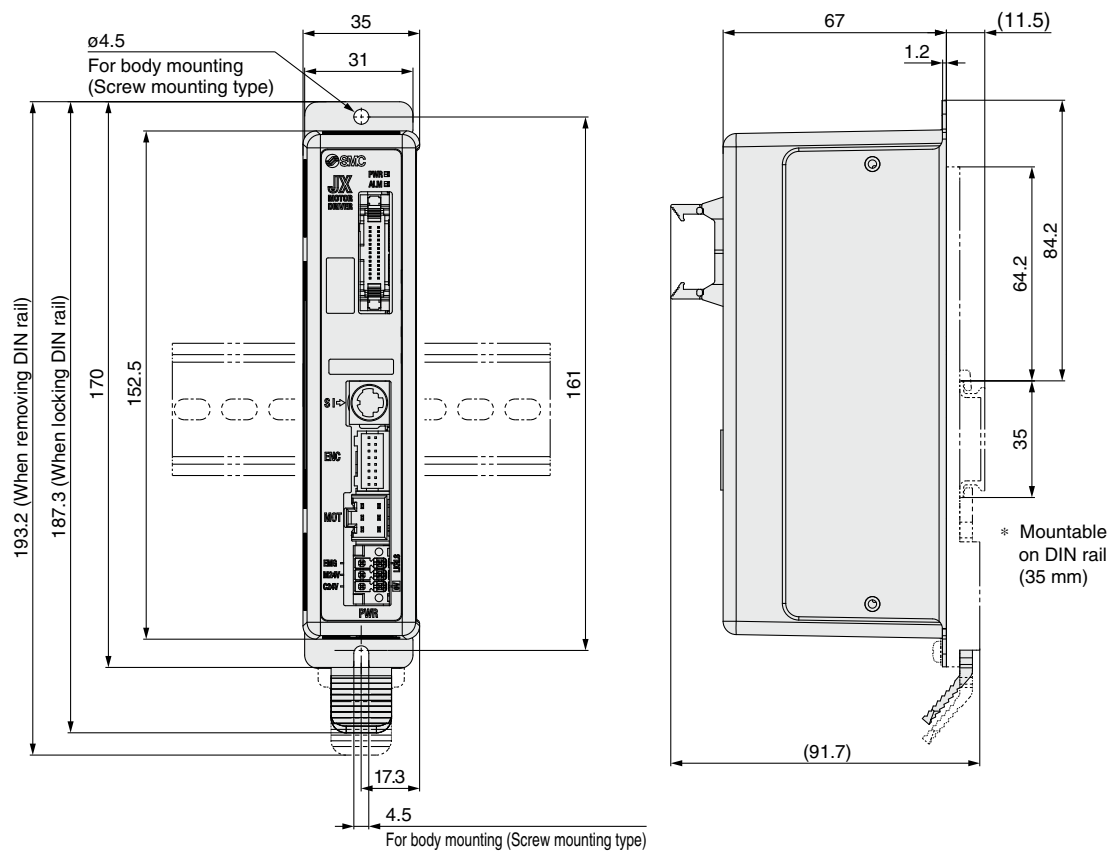

## Wiring Example

### Parallel I/O Connector

- \* When you connect a PLC to the parallel I/O connector, use the I/O cable (LEC-CN5-□).
- \* The wiring changes depending on the type of parallel I/O (NPN or PNP).

### Wiring diagram JXC5H□□ (NPN)

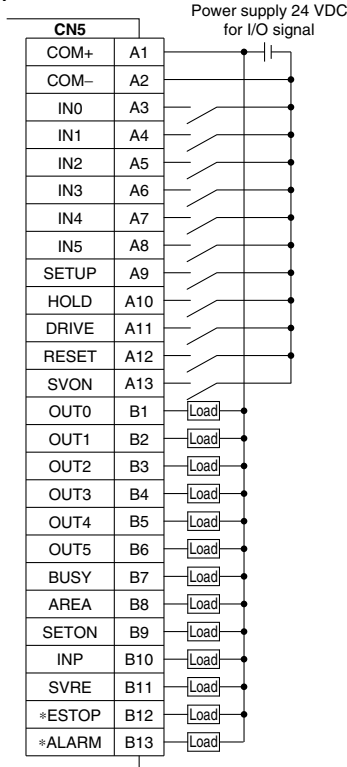

### JXC6H□□ (PNP)

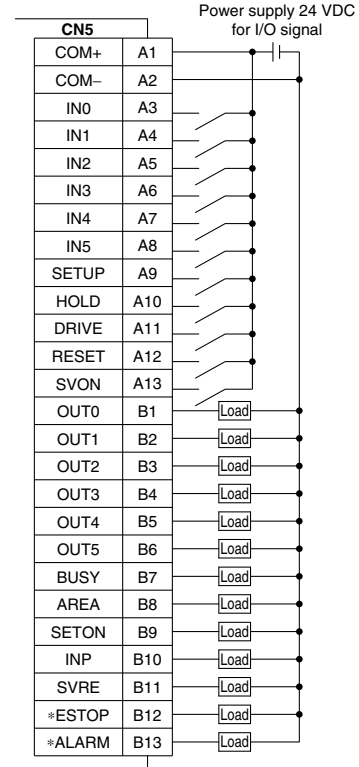

### Input Signal

Name	Details
COM+	Connects the power supply 24 V for input/output signal
COM-	Connects the power supply 0 V for input/output signal
IN0 to IN5	Step data specified bit no. (Input is instructed by combining IN0 to 5.)
SETUP	Instruction to return to origin
HOLD	Temporarily stops operation
DRIVE	Instruction to drive
RESET	Resets alarm and interrupts operation
SVON	Servo ON instruction

### Output Signal

Name	Details
OUT0 to OUT5	Outputs the step data no. during operation
BUSY	Outputs when the actuator is moving
AREA	Outputs within the step data area output setting range
SETON	Outputs when returning to origin
INP	Outputs when target position or target force is reached*2 (Turns on when the positioning or pushing is completed.)
SVRE	Outputs when servo is on
*ESTOP*1	OFF when EMG stop is instructed
*ALARM*1	OFF when alarm is generated

\*1 Signal of negative-logic circuit (N.C.)

\*2 Check the catalog and operation manual of each actuator model which is capable of performing pushing operations.  
The "Specifications" table for models which are capable of performing pushing operations includes an item for the pushing force.

Model Selection

LEFS□G Series

Auto Switch

JXC5H/6H Series

JXCEH/9H/PH Series

# JXC5H/6H Series

## Step Data Setting

### 1. Step data setting for positioning

In this setting, the actuator moves toward and stops at the target position.

The following diagram shows the setting items and operation. The setting items and set values for this operation are stated below.

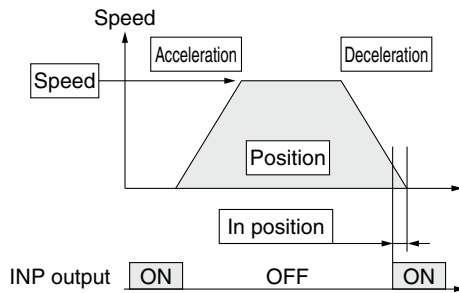

◎ : Need to be set.  
○ : Need to be adjusted as required.  
— : Setting is not required.

#### Step Data (Positioning)

Necessity	Item	Details
◎	Movement MOD	When the absolute position is required, set Absolute. When the relative position is required, set Relative.
◎	Speed	Transfer speed to the target position
◎	Position	Target position
○	Acceleration	Parameter which defines how rapidly the actuator reaches the speed set. The higher the set value, the faster it reaches the speed set.
○	Deceleration	Parameter which defines how rapidly the actuator comes to stop. The higher the set value, the quicker it stops.
◎	Pushing force*1	Set 0. (If values 1 to 100 are set, the operation will be changed to the pushing operation.)
—	Trigger LV	Setting is not required.
—	Pushing speed	Setting is not required.
○	Moving force	Max. torque during the positioning operation (No specific change is required.)
○	Area 1, Area 2	Condition that turns on the AREA output signal.
○	In position	Condition that turns on the INP output signal. When the actuator enters the range of [in position], the INP output signal turns on. (It is unnecessary to change this from the initial value.) When it is necessary to output the arrival signal before the operation is completed, make the value larger.

\*1 Check the catalog and operation manual of each actuator model which is capable of performing pushing operations. The "Specifications" table for models which are capable of performing pushing operations includes an item for the pushing force.

### 2. Step data setting for pushing\*2

The actuator moves toward the pushing start position, and when it reaches that position, it starts pushing with the set force or less.

The following diagram shows the setting items and operation. The setting items and set values for this operation are stated below.

\*2 Check the catalog and operation manual of each actuator model which is capable of performing pushing operations.

The "Specifications" table for models which are capable of performing pushing operations includes an item for the pushing force.

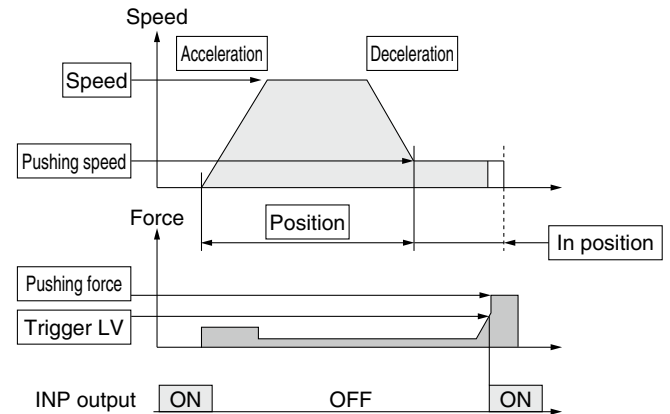

◎ : Need to be set.  
○ : Need to be adjusted as required.

#### Step Data (Pushing)

Necessity	Item	Details
◎	Movement MOD	When the absolute position is required, set Absolute. When the relative position is required, set Relative.
◎	Speed	Transfer speed to the pushing start position
◎	Position	Pushing start position
○	Acceleration	Parameter which defines how rapidly the actuator reaches the speed set. The higher the set value, the faster it reaches the speed set.
○	Deceleration	Parameter which defines how rapidly the actuator comes to stop. The higher the set value, the quicker it stops.
◎	Pushing force*3	Pushing force ratio is defined. The setting range differs depending on the electric actuator type. Refer to the operation manual for the electric actuator.
◎	Trigger LV	Condition that turns on the INP output signal. The INP output signal turns on when the generated force exceeds the value. Trigger level should be the pushing force or less.
○	Pushing speed*3	Pushing speed during pushing. When the speed is set fast, the electric actuator and workpieces might be damaged due to the impact when they hit the end, so this set value should be smaller. Refer to the operation manual for the electric actuator.
○	Moving force	Max. torque during the positioning operation (No specific change is required.)
○	Area 1, Area 2	Condition that turns on the AREA output signal.
◎	In position	Transfer distance during pushing. If the transferred distance exceeds the setting, it stops even if it is not pushing. If the transfer distance is exceeded, the INP output signal will not turn on.

\*3 Check the catalog and operation manual of each actuator model which is capable of performing pushing operations. The "Specifications" table for models which are capable of performing pushing operations includes an item for the pushing force.



## Signal Timing

### Return to Origin

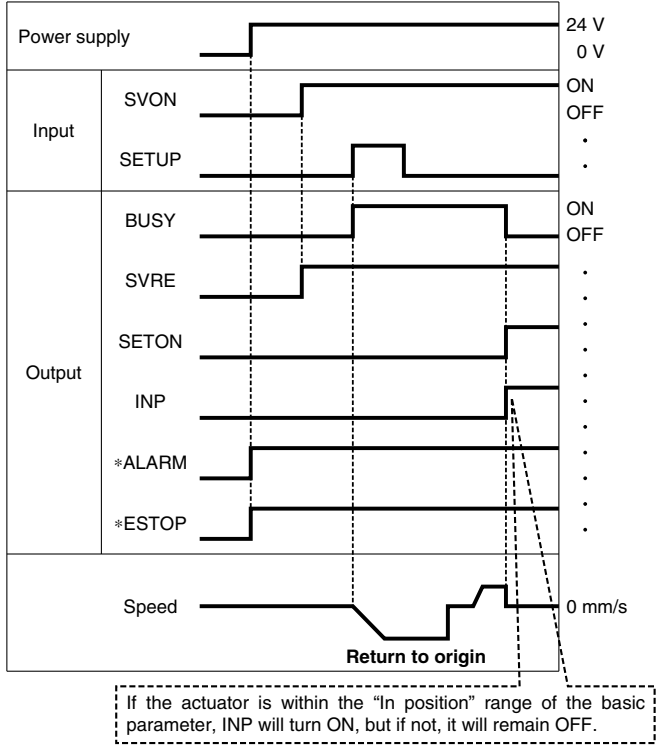

### Positioning Operation

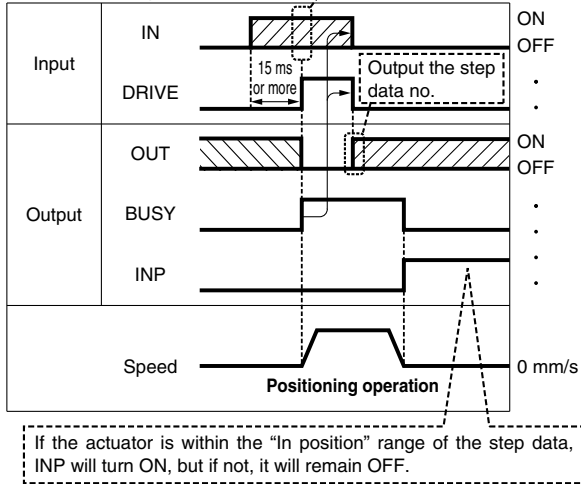

\* "OUT" is output when "DRIVE" is changed from ON to OFF. Refer to the operation manual for details on the controller for the LEM series. (When power supply is applied, "DRIVE" or "RESET" is turned ON or \*ESTOP is turned OFF, all of the "OUT" outputs are OFF.)

### HOLD

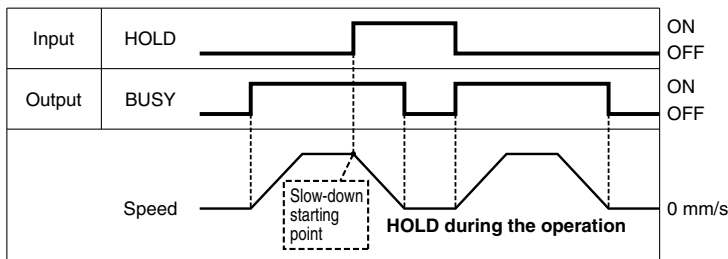

\* When the actuator is within the "In position" range in the pushing operation, it does not stop even if HOLD signal is input.

### Pushing Operation

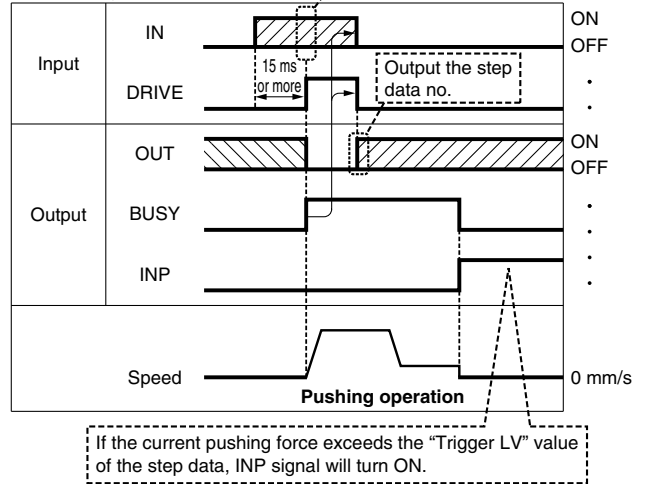

\* Check the catalog and operation manual of each actuator model which is capable of performing pushing operations. The "Specifications" table for models which are capable of performing pushing operations includes an item for the pushing force.

### Reset

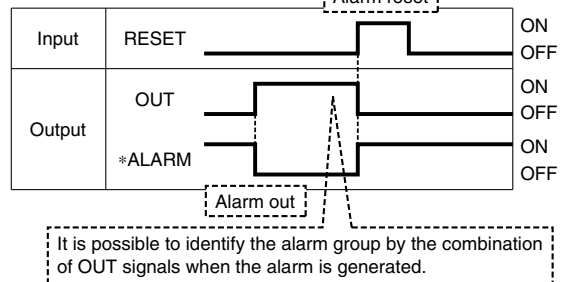

\* \*ALARM is expressed as a negative-logic circuit.

Model Selection

LEFS □ G Series

Auto Switch

JXC5H/6H Series

JXCEH/9H/PH Series

# JXC5H/6H Series

## Options

### ■ Communication cable for controller setting

#### ① Communication cable JXC-W2A-C

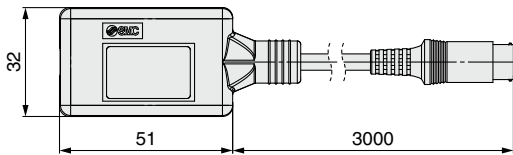

\* It can be connected to the controller directly.

#### ② USB cable LEC-W2-U

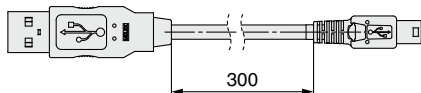

#### ③ Controller setting kit JXC-W2A

A set which includes a communication cable (JXC-W2A-C) and a USB cable (LEC-W2-U)

#### <Controller setting software/USB driver>

- Controller setting software
  - USB driver (For JXC-W2A-C)
- Download from SMC's website:  
<https://www.smcworld.com>

#### Hardware Requirements

OS	Windows®7, Windows®8.1, Windows®10, Windows®11
Communication interface	USB 1.1 or USB 2.0 ports
Display	1024 x 768 or more

\* Windows®7, Windows®8.1, Windows®10, and Windows®11 are registered trademarks of Microsoft Corporation in the United States.

### ■ Conversion cable P5062-5 (Cable length: 300 mm)

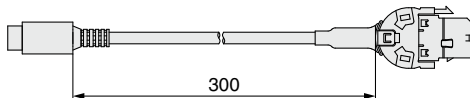

\* To connect the teaching box (LEC-T1-3□G□) or controller setting kit (LEC-W2□) to the controller, a conversion cable is required.

### ■ I/O cable

#### LEC-CN5-1

Cable length (L) [m]	
1	1.5
3	3
5	5

\* Conductor size: AWG28

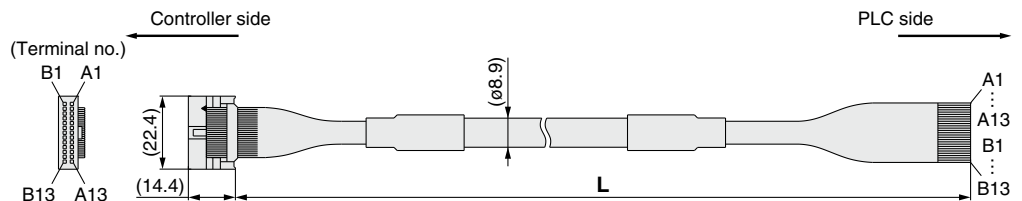

Connector pin no.	Insulation color	Dot mark	Dot color
A1	Light brown	■	Black
A2	Light brown	■	Red
A3	Yellow	■	Black
A4	Yellow	■	Red
A5	Light green	■	Black
A6	Light green	■	Red
A7	Gray	■	Black
A8	Gray	■	Red
A9	White	■	Black
A10	White	■	Red
A11	Light brown	■ ■	Black
A12	Light brown	■ ■	Red
A13	Yellow	■ ■	Black

Connector pin no.	Insulation color	Dot mark	Dot color
B1	Yellow	■ ■	Red
B2	Light green	■ ■	Black
B3	Light green	■ ■	Red
B4	Gray	■ ■	Black
B5	Gray	■ ■	Red
B6	White	■ ■	Black
B7	White	■ ■	Red
B8	Light brown	■ ■ ■	Black
B9	Light brown	■ ■ ■	Red
B10	Yellow	■ ■ ■	Black
B11	Yellow	■ ■ ■	Red
B12	Light green	■ ■ ■	Black
B13	Light green	■ ■ ■	Red
—			Shield

#### Weight

Product no.	Weight [g]
LEC-CN5-1	170
LEC-CN5-3	320
LEC-CN5-5	520

### ■ Power supply plug JXC-CPW

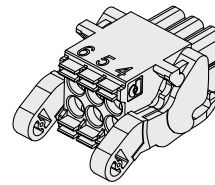

\* The power supply plug is an accessory.  
 <Applicable cable size> AWG20 (0.5 mm<sup>2</sup>), cover diameter 2.0 mm or less

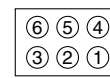

- ① C24V
- ② M24V
- ③ EMG
- ④ 0V
- ⑤ N.C.
- ⑥ LK RLS

#### Power supply plug

Terminal name	Function	Details
0V	Common supply (-)	The M24V terminal, C24V terminal, EMG terminal, and LK RLS terminal are common (-).
M24V	Motor power supply (+)	Motor power supply (+) of the controller
C24V	Control power supply (+)	Control power supply (+) of the controller
EMG	Stop (+)	Connection terminal of the external stop circuit
LK RLS	Lock release (+)	Connection terminal of the lock release switch

### ■ Teaching box

#### LEC-T1-3□J□G□

Teaching box

Cable length [m]  
 3 3

Initial language

J	Japanese
E	English

\* The displayed language can be changed to English or Japanese.

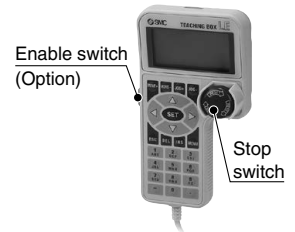

Enable switch

Nil	None
S	Equipped with enable switch

\* Interlock switch for jog and test function

Stop switch

G	Equipped with stop switch
---	---------------------------

#### Specifications

Item	Description
Switch	Stop switch, Enable switch (Option)
Cable length [m]	3
Enclosure	IP64 (Except connector)
Operating temperature range [°C]	5 to 50
Operating humidity range [%RH]	90 or less (No condensation)
Weight [g]	350 (Except cable)

# High Performance Step Motor Controller

## JXCEH/9H/PH Series



Model Selection

LEFS□G Series

Auto Switch

JXC5H/6H Series

JXCEH/9H/PH Series

### How to Order

#### ⚠ Caution

##### [CE/UKCA-compliant products]

- ① EMC compliance was tested by combining the electric actuator LE series and the JXCEH/PH series.  
The EMC depends on the configuration of the customer's control panel and the relationship with other electrical equipment and wiring. Therefore, compliance with the EMC directive cannot be certified for SMC components incorporated into the customer's equipment under actual operating conditions. As a result, it is necessary for the customer to verify compliance with the EMC directive for the machinery and equipment as a whole.
- ② For the JXCEH/PH series (step motor controller), EMC compliance was tested by installing a noise filter set (LEC-NFA). Refer to page 54 for the noise filter set. Refer to the JXCEH/PH Operation Manual for installation.

JXC **P** **H** **7** - □

#### Communication protocol

<b>E</b>	EtherCAT
<b>9</b>	EtherNet/IP™
<b>P</b>	PROFINET

#### High performance

#### Mounting

<b>7</b>	Screw mounting
<b>8</b> *1	DIN rail

\*1 The DIN rail is not included. It must be ordered separately. (Refer to page 54.)



EtherCAT EtherNet/IP PROFINET

#### Actuator part number

Without cable specifications and actuator options  
Example: Enter "LEFS16GB-100"  
for the LEFS16GB-100B-S1□□.

**BC** Blank controller\*1

\*1 Requires dedicated software (JXC-BCW)

#### The controller is sold as single unit after the compatible actuator is set.

Confirm that the combination of the controller and actuator is correct.

- ① Check the actuator label for the model number. This number should match that of the controller.

LEFS16GB-400

①



\* Refer to the operation manual for using the products. Please download it via our website: <https://www.smcworld.com>

#### Precautions for blank controllers (JXC□H□-BC)

A blank controller is a controller to which the customer can write the data of the actuator it is to be combined and used with. Use the dedicated software (JXC-BCW) for data writing.

- Please download the dedicated software (JXC-BCW) via our website.
- Order the communication cable for controller setting (JXC-W2A-C) and USB cable (LEC-W2-U) separately to use this software.

SMC website: <https://www.smcworld.com>

# JXCEH/9H/PH Series

## Specifications

Model		JXCEH	JXC9H	JXCPH	
Network		EtherCAT	EtherNet/IP™	PROFINET	
Compatible motor		Step motor (Servo/24 VDC)			
Power supply		Power voltage: 24 VDC ±10%			
Current consumption (Controller)		200 mA or less	200 mA or less	200 mA or less	
Compatible encoder		Battery-less absolute encoder			
Communication specifications	Applicable system	Protocol	EtherCAT*2	EtherNet/IP™*2	PROFINET*2
		Version*1	Conformance Test Record V.1.2.6	Volume 1 (Edition 3.14) Volume 2 (Edition 1.15)	Specification Version 2.32
	Communication speed	100 Mbps*2	10/100 Mbps*2 (Automatic negotiation)	100 Mbps*2	
	Configuration file*3	ESI file	EDS file	GSDML file	
	I/O occupation area	Input 20 bytes Output 36 bytes	Input 36 bytes Output 36 bytes	Input 36 bytes Output 36 bytes	
	Terminating resistor	Not included			
Memory		EEPROM			
LED indicator		PWR, RUN, ALM, ERR	PWR, ALM, MS, NS	PWR, ALM, SF, BF	
Cable length [m]		Actuator cable: 20 or less			
Cooling system		Natural air cooling			
Operating temperature range [°C]		0 to 40 (No freezing)*4			
Operating humidity range [%RH]		90 or less (No condensation)			
Enclosure		IP30 (Excludes the connector)			
Insulation resistance [MΩ]		Between all external terminals and the case: 50 (500 VDC)			
Weight [g]		260 (Screw mounting) 280 (DIN rail mounting)	250 (Screw mounting) 270 (DIN rail mounting)	260 (Screw mounting) 280 (DIN rail mounting)	

\*1 Please note that versions are subject to change.

\*2 Use a shielded communication cable with CAT5 or higher for the PROFINET, EtherNet/IP™, and EtherCAT.

\*3 The files can be downloaded from the SMC website.

\*4 The operating temperature range for both controller version 1 products and controller version 2 products is 0 to 40°C. Refer to the **Web Catalog** for details on identifying controller version symbols

### ■ Trademark

EtherNet/IP® is a registered trademark of ODVA, Inc.

EtherCAT® is registered trademark and patented technology, licensed by Beckhoff Automation GmbH, Germany.

## Example of Operation Command

In addition to the step data input of 64 points maximum in each communication protocol, the changing of each parameter can be performed in real time via numerical data defined operation.

\* Numerical values other than "Moving force," "Area 1," and "Area 2" can be used to perform operation under numerical instructions from JXCL1.

### <Application example> Movement between 2 points

No.	Movement mode	Speed	Position	Acceleration	Deceleration	Pushing force	Trigger LV	Pushing speed	Moving force	Area 1	Area 2	In position
0	1: Absolute	100	10	3000	3000	0	0	0	100	0	0	0.50
1	1: Absolute	100	100	3000	3000	0	0	0	100	0	0	0.50

### <Step no. defined operation>

Sequence 1: Servo ON instruction

Sequence 2: Instruction to return to origin

Sequence 3: Specify step data No. 0 to input the DRIVE signal.

Sequence 4: Specify step data No. 1 after the DRIVE signal has been temporarily turned OFF to input the DRIVE signal.

### <Numerical data defined operation>

Sequence 1: Servo ON instruction

Sequence 2: Instruction to return to origin

Sequence 3: Specify step data No. 0 and turn ON the input instruction flag (position). Input 10 in the target position. Subsequently the start flag turns ON.

Sequence 4: Turn ON step data No. 0 and the input instruction flag (position) to change the target position to 100 while the start flag is ON.

The same operation can be performed with any operation command.

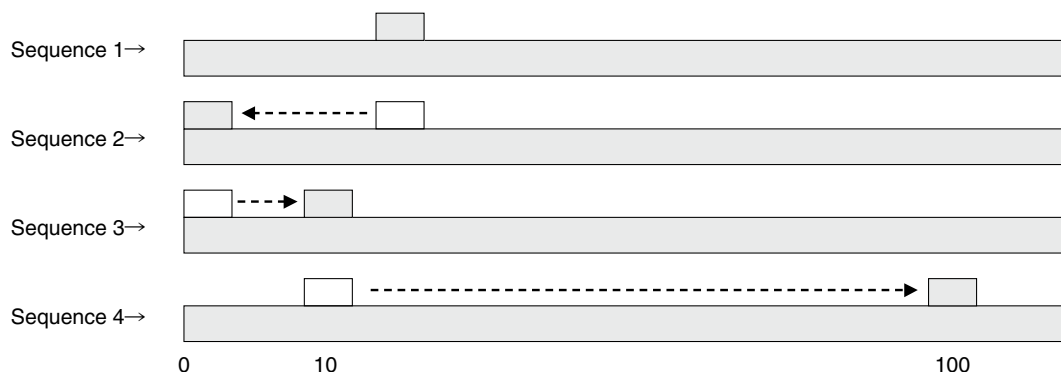

**Dimensions**

**JXCEH**

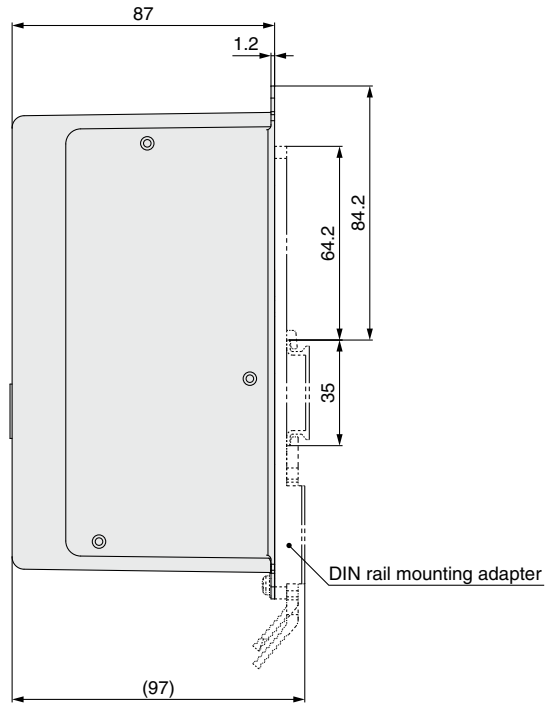
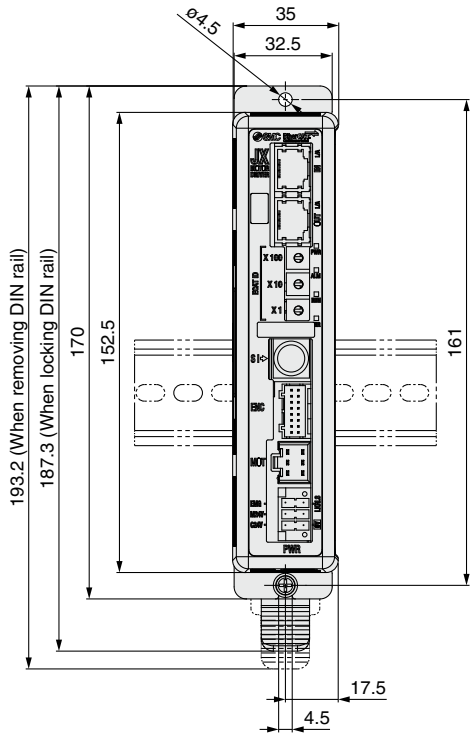

**JXC9H**

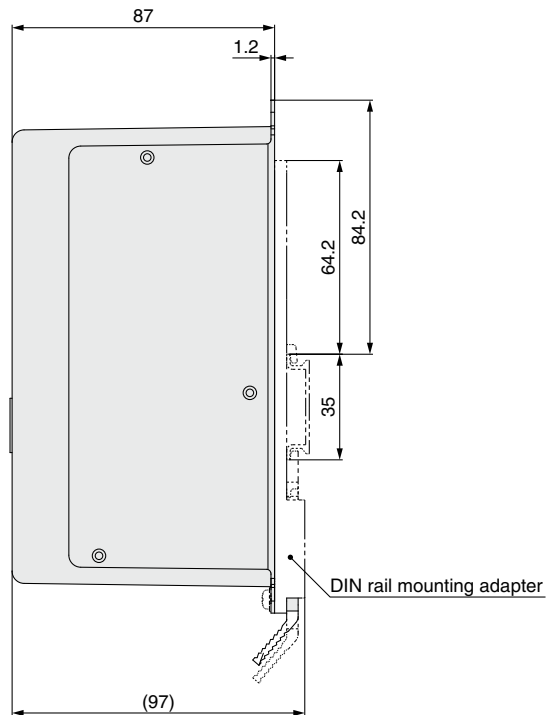
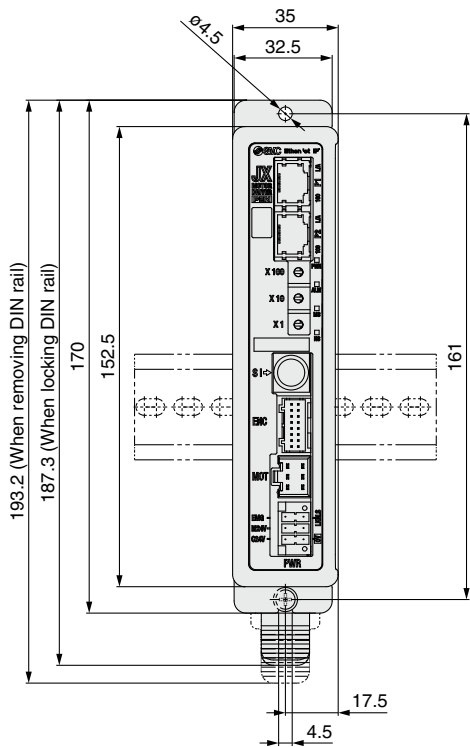

Model Selection

LEFS  G Series

Auto Switch

JXC5H/6H Series

JXCEH/9H/PH Series

# JXCEH/9H/PH Series

## Dimensions

### JXCPH

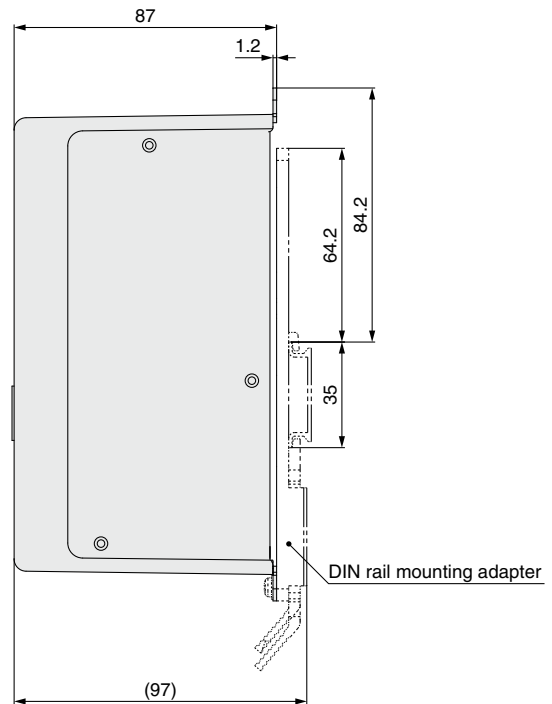
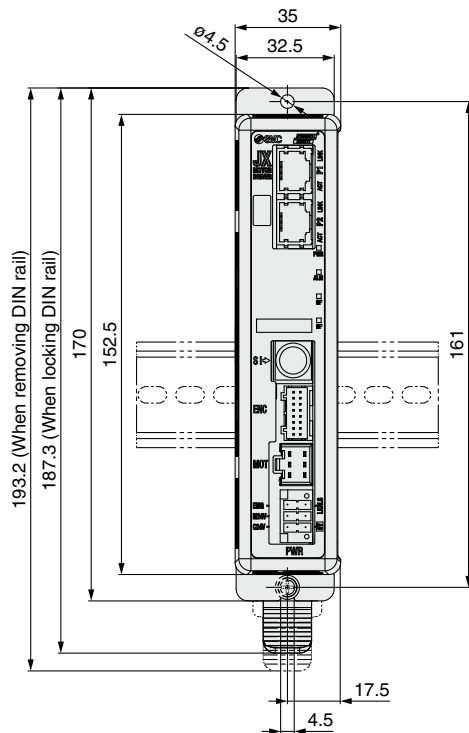

### DIN rail

#### AXT100-DR-□

\* For □, enter a number from the No. line in the table below.  
Refer to the dimension drawings on pages 52 and 53 for the mounting dimensions.

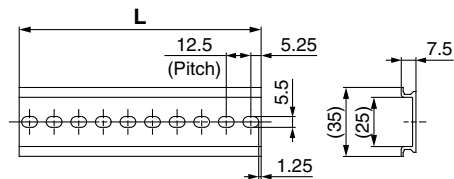

#### L Dimensions [mm]

No.	1	2	3	4	5	6	7	8	9	10	11	12	13	14	15	16	17	18	19	20
<b>L</b>	23	35.5	48	60.5	73	85.5	98	110.5	123	135.5	148	160.5	173	185.5	198	210.5	223	235.5	248	260.5
No.	21	22	23	24	25	26	27	28	29	30	31	32	33	34	35	36	37	38	39	40
<b>L</b>	273	285.5	298	310.5	323	335.5	348	360.5	373	385.5	398	410.5	423	435.5	448	460.5	473	485.5	498	510.5

### DIN rail mounting adapter

#### LEC-3-D0 (with 2 mounting screws)

This should be used when the DIN rail mounting adapter is mounted onto a screw mounting type controller afterward.

## Options

### ■ Communication cable for controller setting

#### ① Communication cable JXC-W2A-C

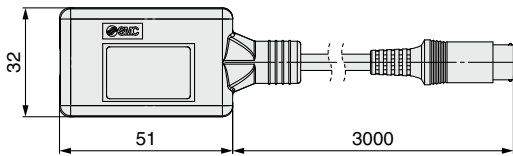

\* It can be connected to the controller directly.

#### ② USB cable LEC-W2-U

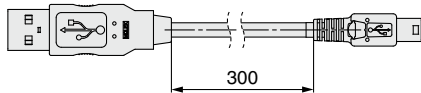

#### ③ Controller setting kit JXC-W2A

A set which includes a communication cable (JXC-W2A-C) and a USB cable (LEC-W2-U)

<Controller setting software/USB driver>

- Controller setting software
- USB driver (For JXC-W2A-C)

Download from SMC's website: <https://www.smcworld.com>

#### Hardware Requirements

OS	Windows®7, Windows®8.1, Windows®10, Windows®11
Communication interface	USB 1.1 or USB 2.0 ports
Display	1024 x 768 or more

\* Windows®7, Windows®8.1, Windows®10, and Windows®11 are registered trademarks of Microsoft Corporation in the United States.

### ■ DIN rail mounting adapter LEC-3-D0

\* With 2 mounting screws

This should be used when the DIN rail mounting adapter is mounted onto a screw mounting type controller afterward.

### ■ DIN rail AXT100-DR-□

\* For □, enter a number from the No. line in the table on pages 44 and 53. Refer to the dimension drawings on pages 45, 52, and 53 for the mounting dimensions.

### ■ Teaching box

#### LEC-T1-3 J G □

Teaching box

Cable length [m]	3
------------------	---

Initial language

J	Japanese
E	English

\* The displayed language can be changed to English or Japanese.

Enable switch (Option)



Enable switch

Nil	None
S	Equipped with enable switch

\* Interlock switch for jog and test function

Stop switch

G	Equipped with stop switch
---	---------------------------

#### Specifications

Item	Description
Switch	Stop switch, Enable switch (Option)
Cable length [m]	3
Enclosure	IP64 (Except connector)
Operating temperature range [°C]	5 to 50
Operating humidity range [%RH]	90 or less (No condensation)
Weight [g]	350 (Except cable)

### ■ Power supply plug JXC-CPW

\* The power supply plug is an accessory.

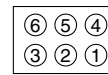
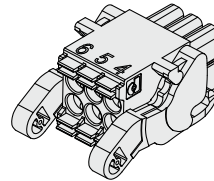

- |        |          |
|--------|----------|
| ① C24V | ④ 0V     |
| ② M24V | ⑤ N.C.   |
| ③ EMG  | ⑥ LK RLS |

#### Power supply plug

Terminal name	Function	Details
0V	Common supply (-)	The M24V terminal, C24V terminal, EMG terminal, and LK RLS terminal are common (-).
M24V	Motor power supply (+)	Motor power supply (+) of the controller
C24V	Control power supply (+)	Control power supply (+) of the controller
EMG	Stop (+)	Connection terminal of the external stop circuit
LK RLS	Lock release (+)	Connection terminal of the lock release switch

### ■ Conversion cable P5062-5 (Cable length: 300 mm)

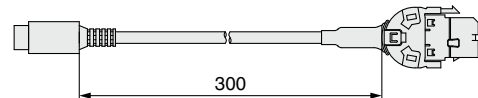

\* To connect the teaching box (LEC-T1-3□G□) or controller setting kit (LEC-W2) to the controller, a conversion cable is required.

### ■ Noise filter set

#### LEC-NFA

Contents of the set: 2 noise filters

(Manufactured by WURTH ELEKTRONIK: 74271222)

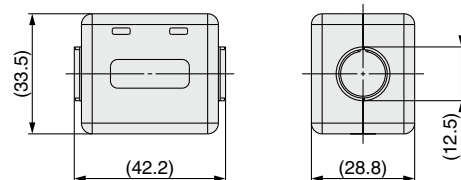

\* Refer to the JXCEH/PH series Operation Manual for installation.

# JXC5H/6H Series JXCEH/9H/PH Series Actuator Cable (Option)

[Robotic cable for battery-less absolute (Step motor 24 VDC)]

**LE-CE-1**

Cable length (L) [m]

1	1.5
3	3
5	5
8	8*1
A	10*1
B	15*1
C	20*1

\*1 Produced upon receipt of order

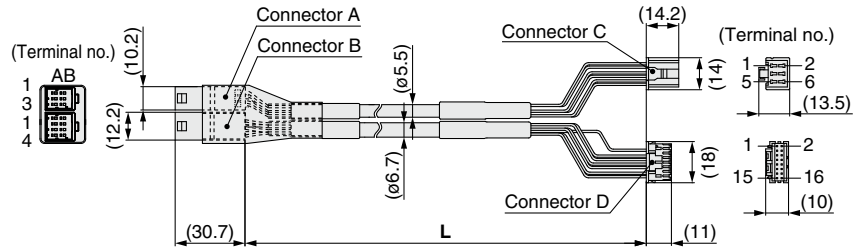

## Weight

Product no.	Weight [g]	Note
LE-CE-1	190	Robotic cable
LE-CE-3	360	
LE-CE-5	570	
LE-CE-8	900	
LE-CE-A	1120	
LE-CE-B	1680	
LE-CE-C	2210	

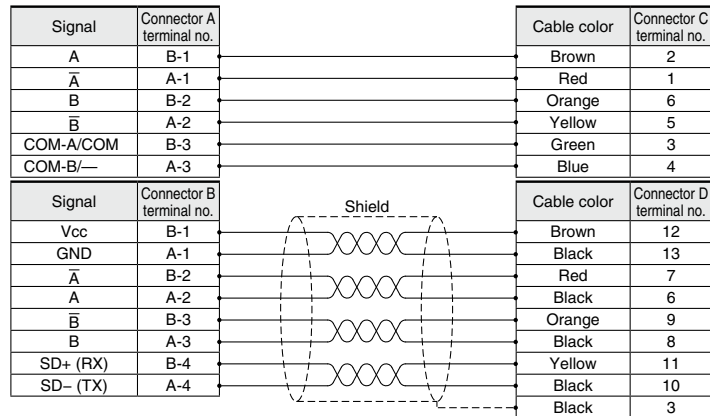

[Robotic cable with lock for battery-less absolute (Step motor 24 VDC)]

**LE-CE-1-B**

Cable length (L) [m]

1	1.5
3	3
5	5
8	8*1
A	10*1
B	15*1
C	20*1

\*1 Produced upon receipt of order

With lock and sensor

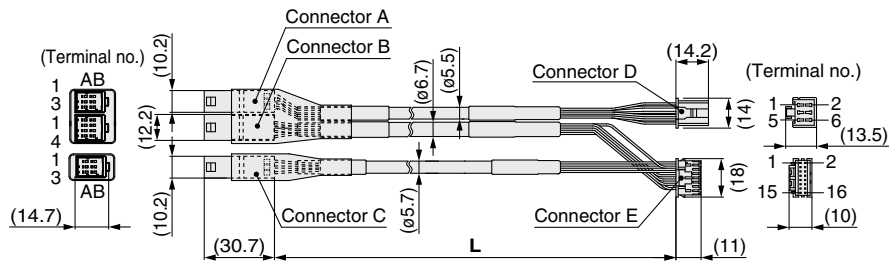

## Weight

Product no.	Weight [g]	Note
LE-CE-1-B	240	Robotic cable
LE-CE-3-B	460	
LE-CE-5-B	740	
LE-CE-8-B	1170	
LE-CE-A-B	1460	
LE-CE-B-B	2120	
LE-CE-C-B	2890	

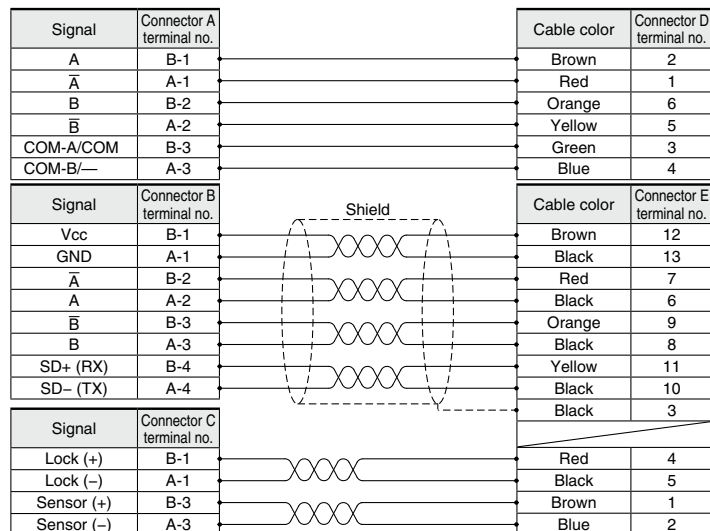





# JXC□1/JXC□F/JXC□H Series

## Precautions Relating to Differences in Controller Versions

As the controller version of the JXC series differs, the internal parameters are not compatible.

- If using the JXC□1□-BC, please use the latest version of the JXC-BCW (parameter writing tool).
- There are currently 3 versions available: version 1 products (V1.□ or S1.□), version 2 products (V2.□ or S2.□), and version 3 products (V3.□ or S3.□). Keep in mind that in order to write a backup file (.bcp) to another controller with the JXC-BCW, it needs to be the same version as the controller that created the file. (For example, a backup file created by a version 1 product can only be written to another version 1 product, and so on.)

### Identifying Version Symbols

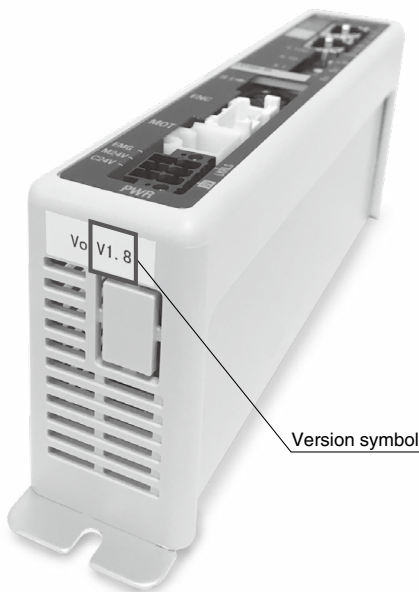

#### JXC□□ Series Version V3.□ or S3.□ Products

XR V3.0

**Applicable models**  
JXC91 Series

XR S3.0 T1.0

**Applicable models**  
JXC51 Series  
JXC61 Series  
JXCE□ Series  
JXCP1 Series  
JXCD1 Series  
JXCL□ Series  
JXCM1 Series

#### JXC□□ Series Version V2.□ or S2.□ Products

WP V2.1

**Applicable models**  
JXC91 Series

WP S2.2 T1.1

**Applicable models**  
JXCE□ Series  
JXCP1 Series  
JXCD1 Series  
JXCL□ Series

#### JXC□□ Series Version V1.□ or S1.□ Products

XR V1.0

**Applicable models**  
JXC91 Series

XR S1.0 T1.0

**Applicable models**  
JXCE□ Series  
JXCP□ Series  
JXCD1 Series  
JXCL□ Series  
JXC5H Series  
JXC6H Series

Model Selection

LEFS□G Series

Auto Switch

JXC5H/6H Series

JXCEH/9H/PH Series

# JXC□H Series

## Blank Controller Versions and Applicable Battery-less Absolute Type Electric Actuator Sizes

- The applicable battery-less absolute type electric actuator size range differs depending on the controller version.  
Be sure to confirm the controller version before using a blank controller.

### Blank Controller Versions/Applicable Electric Actuator Sizes (JXC□H Series)

Blank controller		Applicable electric actuator size				
Series	Controller version	LEFS□G	LEKF□G	LEY□G	LEG	LESYH□G
JXC9H series JXCEH series JXCPH series	All versions	16, 25, 32, 40	25, 32, 40	16, 25, 40	25, 32, 40	8, 16, 25
	Version 1.0	25, 32, 40		25, 40		16, 25
JXC5H/6H series	Version 1.1 or higher	16, 25, 32, 40		16, 25, 40		8, 16, 25



# Battery-less Absolute Encoder Type Specific Product Precautions

Be sure to read this before handling the products. Refer to the back cover for safety instructions. For electric actuator precautions, refer to the “Handling Precautions for SMC Products” and the “Operation Manual” on the SMC website: <https://www.smcworld.com>

## Handling

### Caution

#### 1. Absolute encoder ID mismatch error at the first connection

In the following cases, an “ID mismatch error” alarm occurs after the power is turned ON. Perform a return to origin operation after resetting the alarm before use.

- When an electric actuator is connected and the power is turned ON for the first time after purchase\*1
- When the actuator or motor is replaced
- When the controller is replaced

\*1 If you have purchased an electric actuator and controller with the set part number, the pairing may have already been completed and the alarm may not be generated.

#### “ID mismatch error”

Operation is enabled by matching the encoder ID on the electric actuator side with the ID registered in the controller. This alarm occurs when the encoder ID is different from the registered contents of the controller. By resetting this alarm, the encoder ID is registered (paired) to the controller again.

When a controller is changed after pairing is completed				
	Encoder ID no. (* Numbers below are examples.)			
Actuator	17623	17623	17623	17623
Controller	17623	17699	17699	17623
ID mismatch error occurred?	No	Yes	Error reset ⇒ No	

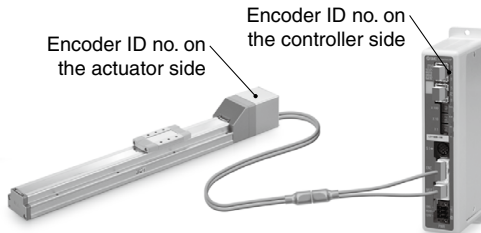

The ID number is automatically checked when the control power supply is turned ON. An error is output if the ID number does not match.

#### 2. In environments where strong magnetic fields are present, use may be limited.

A magnetic sensor is used in the encoder. Therefore, if the actuator motor is used in an environment where strong magnetic fields are present, malfunction or failure may occur. Do not expose the actuator motor to magnetic fields with a magnetic flux density of 1 mT or more.

When installing an electric actuator and an air cylinder with an auto switch (ex. CDQ2 series) or multiple electric actuators side by side, maintain a space of 40 mm or more around the motor. Refer to the construction drawing of the actuator motor.

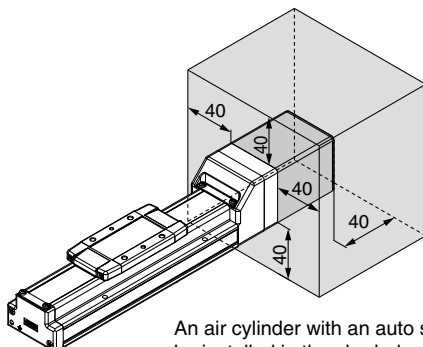

An air cylinder with an auto switch cannot be installed in the shaded area.

#### • When lining up actuators

SMC actuators can be used with their motors adjacent to each other. However, for actuators with a built-in auto switch magnet (the LEY and LEF series), maintain a space of 40 mm or more between the motors and the position where the magnet passes. For the LEF series, the magnet is in the middle of the table, and for the LEY series, the magnet is in the piston portion. (Refer to the construction drawings in the catalog for details.)

Can be used with their motors adjacent to each other

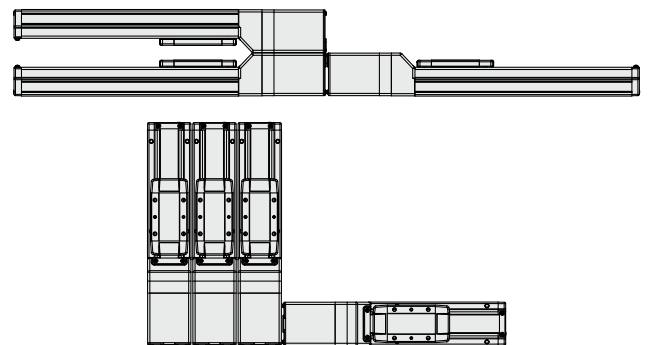

Do not allow the motors to be in close proximity to the position where the magnet passes.

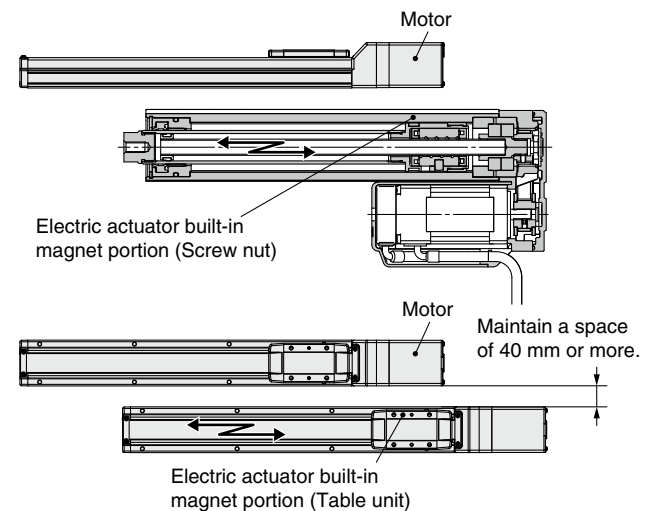

#### 3. The connector size of the motor cable is different from that of the electric actuator with an incremental encoder.

The motor cable connector of an electric actuator with a battery-less absolute encoder is different from that of an electric actuator with an incremental encoder. As the connector cover dimensions are different, take the dimensions below into consideration during the design process.

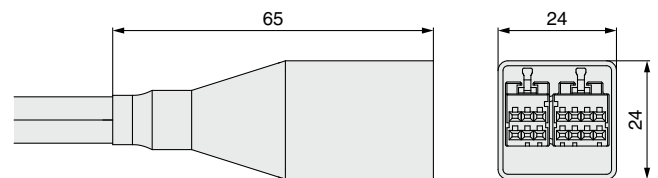

Battery-less absolute encoder connector cover dimensions

# CE/UKCA/UL-compliance List

\* For CE, UKCA, and UL-compliant products, refer to the tables below and the following pages.

## ■ Controllers “○”: Compliant “x”: Not compliant

As of November 2021

Compatible motor	Series	CE UKCA		cULus		Compatible motor	Series	CE UKCA		cULus LISTED	
		Compliance	Certification No. (File No.)	Compliance	Certification No. (File No.)			Compliance	Certification No. (File No.)		
Step motor (Incremental)	JXCE1	○	○	○	E480340	AC servo motor	LECSA	○	○	○	E466261
	JXC91	○	○	○	E480340		LECSB	○	x	○	—
	JXCP1	○	○	○	E480340		LECSC	○	x	○	—
	JXCD1	○	○	○	E480340		LECSS	○	x	○	—
	JXCL1	○	○	○	E480340		LECSB-T	○	○	○	E466261
	JXCLF	○	○	○	E480340		LECSC-T	○	○	○	E466261
	LECP1	○	○	○	E339743		LECSN-T	○	○*1	○	E466261
	LECP2	○	○	○	E339743		LECSS-T	○	○	○	E466261
	LECPA	○	○	○	E339743		LECYM	○	x	○	—
JXC51/61	○	○	○	E480340	LECYU		○	x	○	—	
Step motor (Battery-less absolute)	JXCE1	○	○	○	E480340		*1 Only the “Without network card” option is UL compliant.				
	JXC91	○	○	○	E480340						
	JXCP1	○	○	○	E480340						
	JXCD1	○	○	○	E480340						
	JXCL1	○	○	○	E480340						
	JXCLF	○	○	○	E480340						
	JXCM1	○	○	○	E480340						
High performance step motor (24 VDC)	JXC5H/6H	○	○	○	E480340						
	JXCEH	○	○	○	E480340						
	JXC9H	○	○	○	E480340						
Servo motor (24 VDC)	JXCPH	○	○	○	E480340						
	LECA6	○	○	○	E339743						
Multi-axis step motor controller	JXC73	○	x	○	—						
	JXC83	○	x	○	—						
	JXC93	○	x	○	—						
	JXC92	○	x	○	—						

## ■ Actuators “○”: Compliant “x”: Not compliant

As of November 2021

Compatible motor	Series	CE UKCA		cULus		Compatible motor	Series	CE UKCA		cULus	
		Compliance	Certification No. (File No.)	Compliance	Certification No. (File No.)			Compliance	Certification No. (File No.)		
Step motor (Incremental)	LEFS	○	x	○	—	High performance step motor (24 VDC)	LEFS	○	x	○	—
	11-LEFS	○	x	○	—		Servo motor (24 VDC)	LEFS	○	x	○
	25A-LEFS	○	x	○	—	11-LEFS		○	x	○	—
	LEFB	○	x	○	—	25A-LEFS		○	x	○	—
	LEL	○	x	○	—	LEFB		○	x	○	—
	LEM	○	x	○	—	LEY		○	x	○	—
	LEY	○	x	○	—	LEY-X5/X7		○	x	○	—
	25A-LEY	○	x	○	—	LEYG		○	x	○	—
	LEY-X5/X7	○	x	○	—	LES		○	x	○	—
	LEYG	○	x	○	—	LESH		○	x	○	—
	LES	○	x	○	—	LEPY		○	x	○	—
	LESH	○	x	○	—	LEPS		○	x	○	—
	LEPY	○	x	○	—	LER	○	x	○	—	
	LEPS	○	x	○	—	LEHZ	○	x	○	—	
	LER	○	x	○	—	LEHZJ	○	x	○	—	
	LEHZ	○	x	○	—	LEHF	○	x	○	—	
	LEHZJ	○	x	○	—	LEHS	○	x	○	—	
	LEHF	○	x	○	—	AC servo motor	LEFS	○	x	○	—
	LEHS	○	x	○	—		11-LEFS	○	x	○	—
	Step motor (Battery-less absolute)	LEFS	○	x	○		—	25A-LEFS	○	x	○
LEFB		○	x	○	—		LEFB	○	x	○	—
LEKFS		○	x	○	—		LEJS	○	x	○	—
LEY		○	x	○	—		11-LEJS	○	x	○	—
LEY-X8		○	x	○	—		25A-LEJS	○	x	○	—
LEYG		○	x	○	—		LEJB	○	x	○	—
LES		○	x	○	—		LEY25/32/63	○	x	○	—
LESH		○	x	○	—		LEY100	○	x	○	—
LESYH		○	x	○	—		LEYG	○	x	○	—
LER		○	x	○	—	LESYH	○	x	○	—	
LEHF		○	x	○	—						

\* Actuators ordered as single units are not UL compliant.



# CE/UKCA/UL-compliance List

## ■ Actuators (When ordered with a controller) “○”: Compliant “x”: Not compliant “—”: Not applicable As of November 2021

Compatible motor	Series	JXC51/61			JXCE1			JXC91			JXCP1			JXCD1		
		CE UK CA	cRU <sup>us</sup>		CE UK CA	cRU <sup>us</sup>		CE UK CA	cRU <sup>us</sup>		CE UK CA	cRU <sup>us</sup>		CE UK CA	cRU <sup>us</sup>	
			Compliance	Certification No. (File No.)		Compliance	Certification No. (File No.)		Compliance	Certification No. (File No.)		Compliance	Certification No. (File No.)		Compliance	Certification No. (File No.)
Step motor (Battery-less absolute)	LEFS	○	x	—	○	x	—	○	x	—	○	x	—	○	x	—
	LEFB	○	x	—	○	x	—	○	x	—	○	x	—	○	x	—
	LEKFS	○	x	—	○	x	—	○	x	—	○	x	—	○	x	—
	LEY	○	x	—	○	x	—	○	x	—	○	x	—	○	x	—
	LEY-X8	○	x	—	○	x	—	○	x	—	○	x	—	○	x	—
	LEYG	○	x	—	○	x	—	○	x	—	○	x	—	○	x	—
	LES	○	x	—	○	x	—	○	x	—	○	x	—	○	x	—
	LESH	○	x	—	○	x	—	○	x	—	○	x	—	○	x	—
	LESYH	○	x	—	○	x	—	○	x	—	○	x	—	○	x	—
	LER	○	x	—	○	x	—	○	x	—	○	x	—	○	x	—
LEHF	○	x	—	○	x	—	○	x	—	○	x	—	○	x	—	

Compatible motor	Series	JXCL1			JXCLF			JXCM1		
		CE UK CA	cRU <sup>us</sup>		CE UK CA	cRU <sup>us</sup>		CE UK CA	cRU <sup>us</sup>	
			Compliance	Certification No. (File No.)		Compliance	Certification No. (File No.)		Compliance	Certification No. (File No.)
Step motor (Battery-less absolute)	LEFS	○	x	—	○	x	—	○	x	—
	LEFB	○	x	—	○	x	—	○	x	—
	LEKFS	○	x	—	○	x	—	○	x	—
	LEY	○	x	—	○	x	—	○	x	—
	LEY-X8	○	x	—	○	x	—	○	x	—
	LEYG	○	x	—	○	x	—	○	x	—
	LES	○	x	—	○	x	—	○	x	—
	LESH	○	x	—	○	x	—	○	x	—
	LESYH	○	x	—	○	x	—	○	x	—
	LER	○	x	—	○	x	—	○	x	—
LEHF	○	x	—	○	x	—	○	x	—	

# CE/UKCA/UL-compliance List

## ■ Actuators (When ordered with a controller) "O": Compliant "x": Not compliant "—": Not applicable As of November 2021

Compatible motor	Series	JXC5H/6H			JXCEH			JXC9H			JXCPH		
		CE UK CA	cRU <sup>us</sup>		CE UK CA	cRU <sup>us</sup>		CE UK CA	cRU <sup>us</sup>		CE UK CA	cRU <sup>us</sup>	
			Compliance	Certification No. (File No.)		Compliance	Certification No. (File No.)		Compliance	Certification No. (File No.)		Compliance	Certification No. (File No.)
High performance step motor (24 VDC)	LEF	O	O	E339743	O	O	E339743	O	O	E339743	O	O	E339743

Compatible motor	Series	JXC5H/6H			JXCEH			JXC9H			JXCPH		
		CE UK CA	cRU <sup>us</sup>		CE UK CA	cRU <sup>us</sup>		CE UK CA	cRU <sup>us</sup>		CE UK CA	cRU <sup>us</sup>	
			Compliance	Certification No. (File No.)		Compliance	Certification No. (File No.)		Compliance	Certification No. (File No.)		Compliance	Certification No. (File No.)
High performance (Battery-less absolute)	LEF	O	x	—	O	x	—	O	x	—	O	x	—

Compatible motor	Series	LECA6		
		CE UK CA	cRU <sup>us</sup>	
			Compliance	Certification No. (File No.)
Servo motor (24 VDC)	LEFS	O	O	E339743
	11-LEFS	O	O	E339743
	25A-LEFS	O	O	E339743
	LEFB	O	O	E339743
	LEY	O	O	E339743
	LEY-X7	O	x	—
	LEYG	O	O	E339743
	LES	O	O	E339743
	LESH	O	O	E339743

Compatible motor	Series	LECSA*1			LECSB			LECSA			LECSS			LECSB-T*1			
		CE UK CA	cRU <sup>us</sup>		CE UK CA	cRU <sup>us</sup>		CE UK CA	cRU <sup>us</sup>		CE UK CA	cRU <sup>us</sup>		CE UK CA	cRU <sup>us</sup>		
			Compliance	Certification No. (File No.)		Compliance	Certification No. (File No.)		Compliance	Certification No. (File No.)		Compliance	Certification No. (File No.)		Compliance	Certification No. (File No.)	Compliance
AC servo motor	LEFS	O	O	E339743	O	x	—	O	x	—	O	x	—	O	x	—	
	11-LEFS	O	O	E339743	O	x	—	O	x	—	O	x	—	O	x	—	
	25A-LEFS	O	O	E339743	O	x	—	O	x	—	O	x	—	O	x	—	
	LEFB	O	O	E339743	O	x	—	O	x	—	O	x	—	O	x	—	
	LEJS	O	O	E339743	O	x	—	O	x	—	O	x	—	O	x	—	
	11-LEJS	O	O	E339743	O	x	—	O	x	—	O	x	—	O	x	—	
	25A-LEJS	O	O	E339743	O	x	—	O	x	—	O	x	—	O	x	—	
	LEJB	O	O	E339743	O	x	—	O	x	—	O	x	—	O	x	—	
	LEY25/32/63	O	O	E339743	O	x	—	O	x	—	O	x	—	O	x	—	
	LEY100	—	—	—	—	—	—	—	—	—	—	—	—	—	—	—	—
	LEYG	O	O	E339743	O	x	—	O	x	—	O	x	—	O	x	—	
LESYH	O	x	—	—	—	—	—	—	—	—	—	—	O	x	—		

Compatible motor	Series	LECSA-T*1			LECSN-T*1			LECSS-T*1		
		CE UK CA	cRU <sup>us</sup>		CE UK CA	cRU <sup>us</sup>		CE UK CA	cRU <sup>us</sup>	
			Compliance	Certification No. (File No.)		Compliance	Certification No. (File No.)		Compliance	Certification No. (File No.)
AC servo motor	LEFS	O	x	—	O	x	—	O	O	E339743
	11-LEFS	O	x	—	O	x	—	O	O	E339743
	25A-LEFS	O	x	—	O	x	—	O	O	E339743
	LEFB	O	x	—	O	x	—	O	O	E339743
	LEJS	O	x	—	O	x	—	O	O	E339743
	11-LEJS	O	x	—	O	x	—	O	O	E339743
	25A-LEJS	O	x	—	O	x	—	O	O	E339743
	LEJB	O	x	—	O	x	—	O	O	E339743
	LEY25/32/63	O	x	—	O	x	—	O	O	E339743
	LEY100	O	x	—	O	x	—	O	O	—
	LEYG	O	x	—	O	x	—	O	O	E339743
LESYH	O	x	—	O	x	—	O	O	—	

\*1 There is a "UL Listed" mark on the AC servo motor driver body.

## Safety Instructions

These safety instructions are intended to prevent hazardous situations and/or equipment damage. These instructions indicate the level of potential hazard with the labels of “**Caution**,” “**Warning**” or “**Danger**.” They are all important notes for safety and must be followed in addition to International Standards (ISO/IEC)\*1), and other safety regulations.

 **Caution:** **Caution** indicates a hazard with a low level of risk which, if not avoided, could result in minor or moderate injury.

 **Warning:** **Warning** indicates a hazard with a medium level of risk which, if not avoided, could result in death or serious injury.

 **Danger :** **Danger** indicates a hazard with a high level of risk which, if not avoided, will result in death or serious injury.

\*1) ISO 4414: Pneumatic fluid power – General rules relating to systems.  
ISO 4413: Hydraulic fluid power – General rules relating to systems.  
IEC 60204-1: Safety of machinery – Electrical equipment of machines.  
(Part 1: General requirements)  
ISO 10218-1: Manipulating industrial robots – Safety.  
etc.

### Warning

#### 1. The compatibility of the product is the responsibility of the person who designs the equipment or decides its specifications.

Since the product specified here is used under various operating conditions, its compatibility with specific equipment must be decided by the person who designs the equipment or decides its specifications based on necessary analysis and test results. The expected performance and safety assurance of the equipment will be the responsibility of the person who has determined its compatibility with the product. This person should also continuously review all specifications of the product referring to its latest catalog information, with a view to giving due consideration to any possibility of equipment failure when configuring the equipment.

#### 2. Only personnel with appropriate training should operate machinery and equipment.

The product specified here may become unsafe if handled incorrectly. The assembly, operation and maintenance of machines or equipment including our products must be performed by an operator who is appropriately trained and experienced.

#### 3. Do not service or attempt to remove product and machinery/equipment until safety is confirmed.

1. The inspection and maintenance of machinery/equipment should only be performed after measures to prevent falling or runaway of the driven objects have been confirmed.
2. When the product is to be removed, confirm that the safety measures as mentioned above are implemented and the power from any appropriate source is cut, and read and understand the specific product precautions of all relevant products carefully.
3. Before machinery/equipment is restarted, take measures to prevent unexpected operation and malfunction.

#### 4. Contact SMC beforehand and take special consideration of safety measures if the product is to be used in any of the following conditions.

1. Conditions and environments outside of the given specifications, or use outdoors or in a place exposed to direct sunlight.
2. Installation on equipment in conjunction with atomic energy, railways, air navigation, space, shipping, vehicles, military, medical treatment, combustion and recreation, or equipment in contact with food and beverages, emergency stop circuits, clutch and brake circuits in press applications, safety equipment or other applications unsuitable for the standard specifications described in the product catalog.
3. An application which could have negative effects on people, property, or animals requiring special safety analysis.
4. Use in an interlock circuit, which requires the provision of double interlock for possible failure by using a mechanical protective function, and periodical checks to confirm proper operation.

### Caution

#### 1. The product is provided for use in manufacturing industries.

The product herein described is basically provided for peaceful use in manufacturing industries.  
If considering using the product in other industries, consult SMC beforehand and exchange specifications or a contract if necessary.  
If anything is unclear, contact your nearest sales branch.

### Limited warranty and Disclaimer/ Compliance Requirements

The product used is subject to the following “Limited warranty and Disclaimer” and “Compliance Requirements”.

Read and accept them before using the product.

#### Limited warranty and Disclaimer

1. The warranty period of the product is 1 year in service or 1.5 years after the product is delivered, whichever is first.\*2)  
Also, the product may have specified durability, running distance or replacement parts. Please consult your nearest sales branch.
2. For any failure or damage reported within the warranty period which is clearly our responsibility, a replacement product or necessary parts will be provided.  
This limited warranty applies only to our product independently, and not to any other damage incurred due to the failure of the product.
3. Prior to using SMC products, please read and understand the warranty terms and disclaimers noted in the specified catalog for the particular products.

##### \*2) Vacuum pads are excluded from this 1 year warranty.

A vacuum pad is a consumable part, so it is warranted for a year after it is delivered.  
Also, even within the warranty period, the wear of a product due to the use of the vacuum pad or failure due to the deterioration of rubber material are not covered by the limited warranty.

#### Compliance Requirements

1. The use of SMC products with production equipment for the manufacture of weapons of mass destruction (WMD) or any other weapon is strictly prohibited.
2. The exports of SMC products or technology from one country to another are governed by the relevant security laws and regulations of the countries involved in the transaction. Prior to the shipment of a SMC product to another country, assure that all local rules governing that export are known and followed.

### Caution

#### SMC products are not intended for use as instruments for legal metrology.

Measurement instruments that SMC manufactures or sells have not been qualified by type approval tests relevant to the metrology (measurement) laws of each country. Therefore, SMC products cannot be used for business or certification ordained by the metrology (measurement) laws of each country.

 **Safety Instructions** Be sure to read the “Handling Precautions for SMC Products” (M-E03-3) and “Operation Manual” before use.

## SMC Corporation

Akihabara UDX 15F,  
4-14-1, Sotokanda, Chiyoda-ku, Tokyo 101-0021, JAPAN  
Phone: 03-5207-8249 Fax: 03-5298-5362  
<https://www.smcworld.com>  
© 2022 SMC Corporation All Rights Reserved

Specifications are subject to change without prior notice  
and any obligation on the part of the manufacturer.

D-G