

Dust-tight/Water-jet-proof (IP69K Equivalent)

Electric Actuator/ Rod Type

AC Servo Motor

New
CE UK CA
— For details, refer to page 21. —

RoHS

Enclosure: IP69K equivalent

External parts Stainless steel 304

Grease NSF-H1 grade



Size

25, 32, 63

Scraper, Static seal

US FDA compliant material (Blue)

Equipment for the Food Manufacturing Industry

HF2A- Series

- Lubricants or rust proof agents are not used for the external parts. Otherwise, lubricants or rust proof agents for the food machinery are being used.
- US FDA compliant materials are used.

AC Servo Motor Drivers

For absolute encoders

- Pulse input type/
Positioning type
LECSB-T Series
- Network card type
LECSN-T Series
- CC-Link direct input type
LECSC-T Series
- SSCNETⅢ/H type
LECSS-T Series



For incremental encoders

- Pulse input type/
Positioning type
LECSA Series



CE UK CA UL US LISTED
* For details, refer to page 21.



More information
can be viewed here.

HF2A-LEY Series



CAT.ES100-171A

Dust-tight/Water-jet-proof (IP69K Equivalent)

Rod Type **HF2A-LEY Series**

AC Servo Motor

Enclosure: IP69K equivalent

Smooth design for less residual liquid accumulation

- External parts: **Stainless steel 304**
- Scraper, Static seal: **US FDA compliant material (Blue)**
- Grease: **NSF-H1 grade**



IP69K is the degree of protection against dust and high-temperature/high-pressure water washdown specified in DIN 40050-9 and currently specified in ISO 20653 and JIS D 5020.
 * Test environment: Temperature 75 to 85°C, water pressure 8 to 10 MPa, flow rate 14 to 16 L/min, four nozzle angles (0°, 30°, 60°, 90°), turntable rotating at 4 to 6 r/min, test duration 30 seconds per surface at 10 to 15 cm distance.

Variations

Size	Screw lead [mm]	Stroke [mm]	Work load (Horizontal/Vertical) [kg]	Force [N]	Max. speed [mm/s]	Mounting	Rod end thread
25	12	50 to 400	18/8	65 to 131	900	Foot bracket Rod flange	Male thread Female thread
	6		50/16	127 to 255	450		
	3		50/30	242 to 485	225		
32	20	50 to 500	30/9	79 to 157	1200		
	10		60/19	154 to 308	600		
	5		60/37	294 to 588	300		
63	20	50 to 800	40/19	156 to 521	1000		
	10		70/38	304 to 1012	500		
	5		80/72	573 to 1910	250		

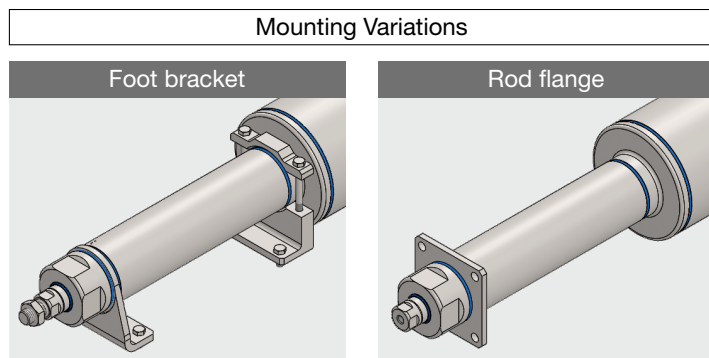

Work load

Max. 80 kg^{*1}

Stroke







Max. 800 mm^{*2}

*1 Size 63, Lead C *2 Size 63

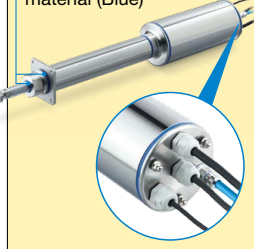
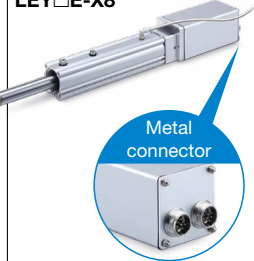
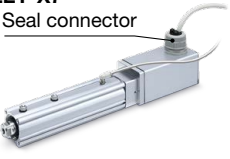
Related Products

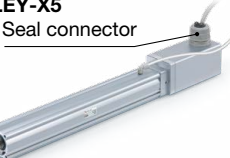
Dust-tight/Water-jet-proof (IP69K Equivalent), Dust-tight/Water-jet-proof (IP65 Equivalent/IP67 Equivalent), Dust-tight/Water-jet-proof (IP65 Equivalent)

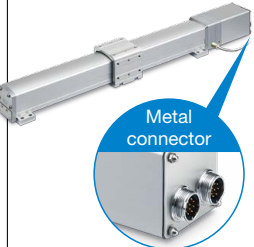
Variations

Series	Dust-tight/Water-jet-proof			Size	Battery-less absolute (Step motor 24 VDC)	Incremental (Step motor 24 VDC)	Incremental (Servo motor 24 VDC)	AC servo motor	Page
	IP69K equivalent	IP65 equivalent/ IP67 equivalent	IP65 equivalent						
HF2A-LEY Scraper, Static seal US FDA compliant material (Blue) 	●			25 32 63				●	7
LEY□E-X8 		●		25 32 40	●				
LEY-X7 Seal connector 		●		25 32 40		●	●		
LEY-X5 Seal connector 			●	25 32		●	●	●	
LEY63□□□-□P 			●	63				●	
LEFSW 			●	16 25 32 40	●				

System Construction

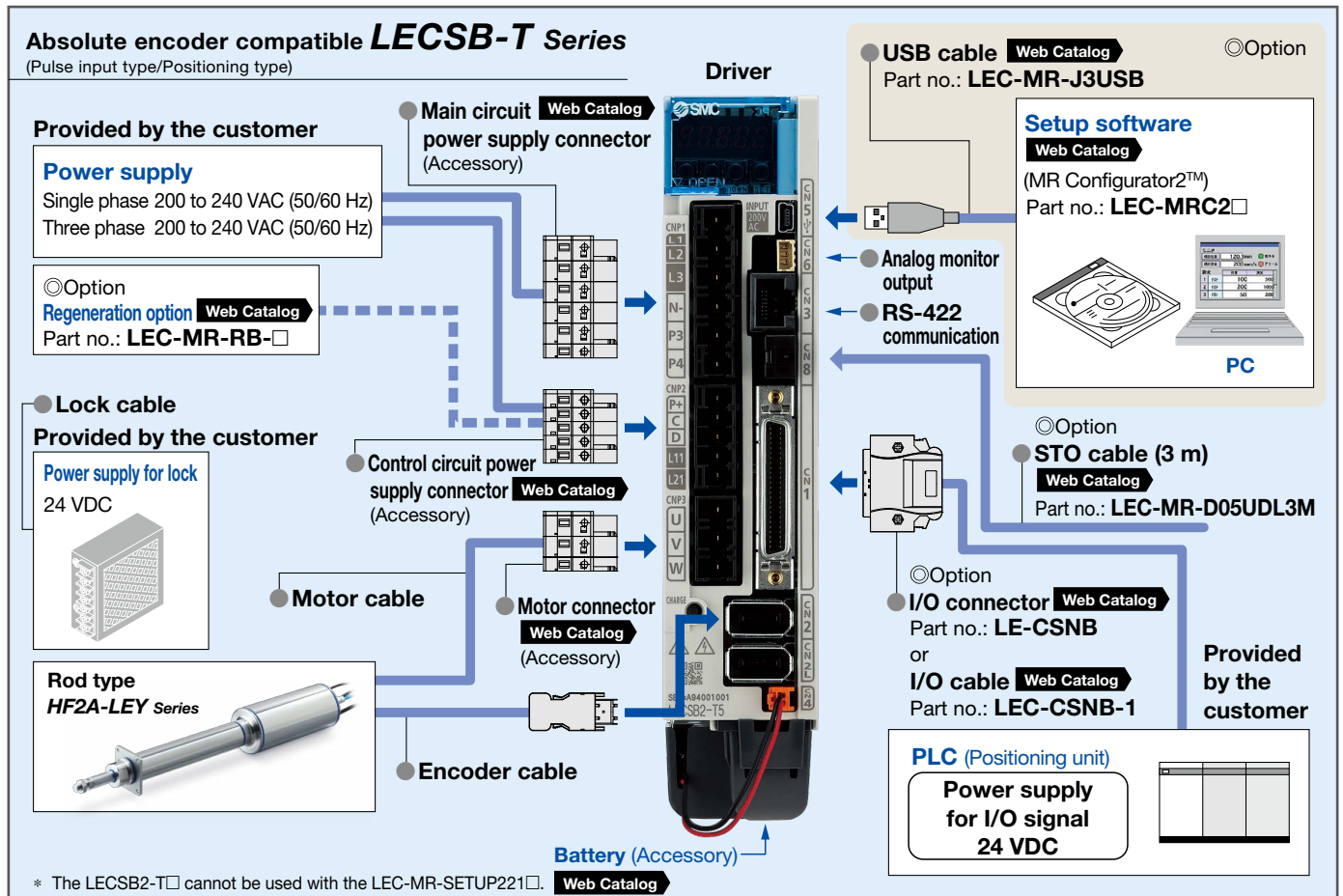
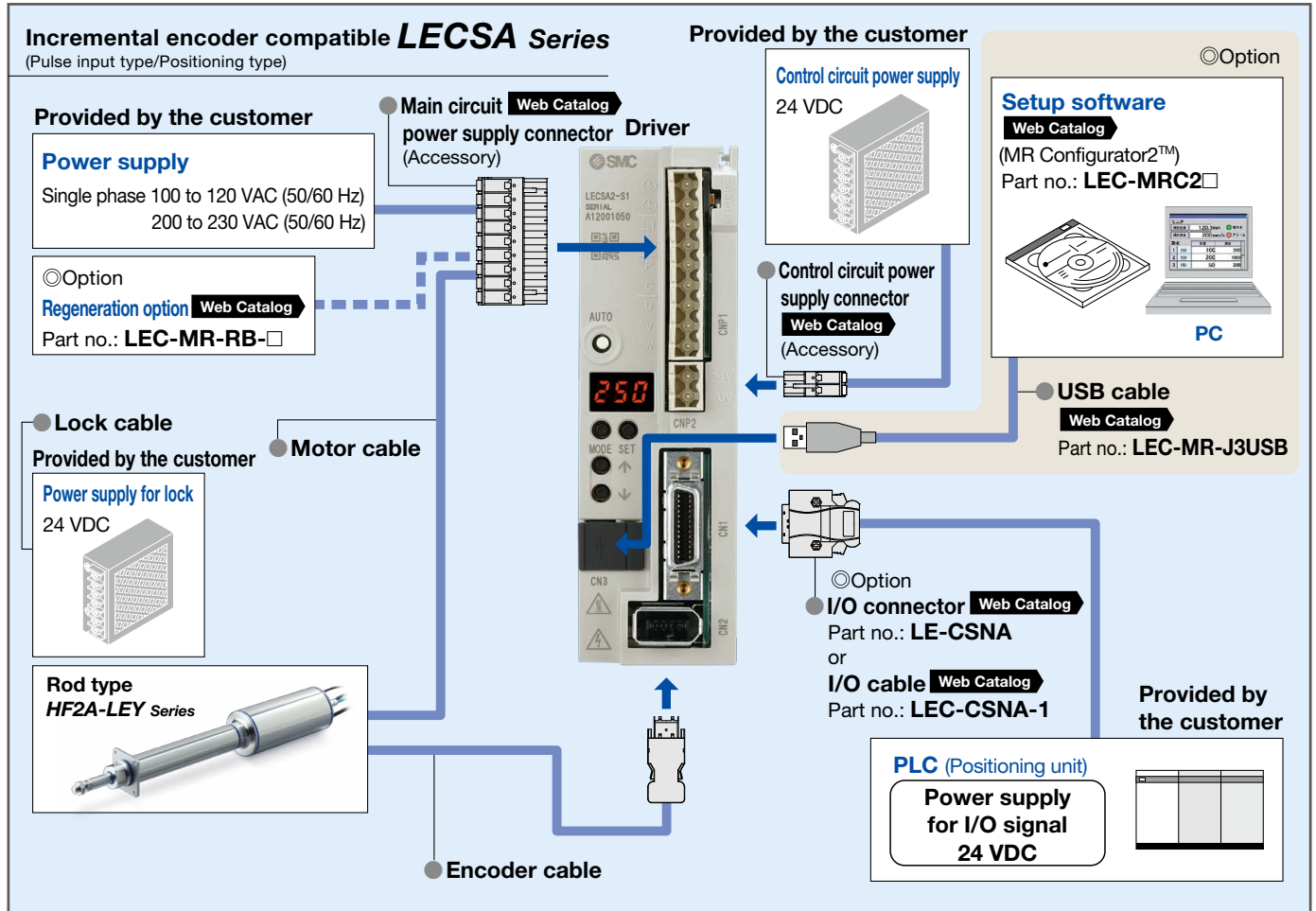

System Construction

Absolute encoder compatible **LECS**□-T Series

(CC-Link direct input type)

Provided by the customer

Power supply

Single phase 200 to 230 VAC (50/60 Hz)
Three phase 200 to 230 VAC (50/60 Hz)

Option

Regeneration option Part no.: **LEC-MR-RB**-□

Motor cable

Lock cable

Provided by the customer

Power supply for lock
24 VDC

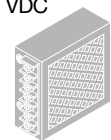

Rod type

HF2A-LEY Series



Main circuit power supply connector (Accessory)

Control circuit power supply connector (Accessory)

Motor connector (Accessory)

Encoder cable

Battery (Accessory)

Driver

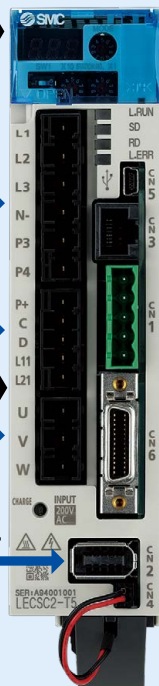

USB cable Part no.: **LEC-MR-J3USB**

Setup software

(MR Configurator2™)
Part no.: **LEC-MRC2**□



PC

RS-422 communication

CC-Link connector*1 (Accessory)

Option I/O connector Part no.: **LE-CSNA**
or I/O cable Part no.: **LEC-CSNA-1**

Provided by the customer

PLC (CC-Link master unit)

Power supply for I/O signal
24 VDC

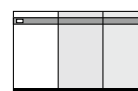

*1 Product number: K05A50230600 manufactured by Mitsubishi Electric System & Service Co., Ltd.

* The LECS2-T□ cannot be used with the LEC-MR-SETUP221□.

Absolute encoder compatible **LECS**□-T Series

(Network card type)

Provided by the customer

Power supply

Single phase 200 to 240 VAC (50/60 Hz)
Three phase 200 to 240 VAC (50/60 Hz)

Option

Regeneration option Part no.: **LEC-MR-RB**-□

Lock cable

Provided by the customer

Power supply for lock
24 VDC

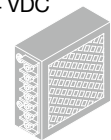

Rod type

HF2A-LEY Series



Main circuit power supply connector (Accessory)

Control circuit power supply connector (Accessory)

Motor connector (Accessory)

Encoder cable

Driver



USB cable Part no.: **LEC-MR-J3USB**

Setup software

(MR Configurator2™)
Part no.: **LEC-MRC2**□



PC

Option Network card Part no.: **LEC-S-N**□

Option STO cable (3 m) Part no.: **LEC-MR-D05UDL3M**

Option I/O connector Part no.: **LE-CSNS**
or I/O cable Part no.: **LEC-CSNS-1**

Provided by the customer

PLC (Positioning unit)

Power supply for I/O signal
24 VDC

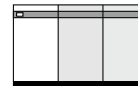

* The LECSN2-T□ cannot be used with the LEC-MR-SETUP221□.

System Construction

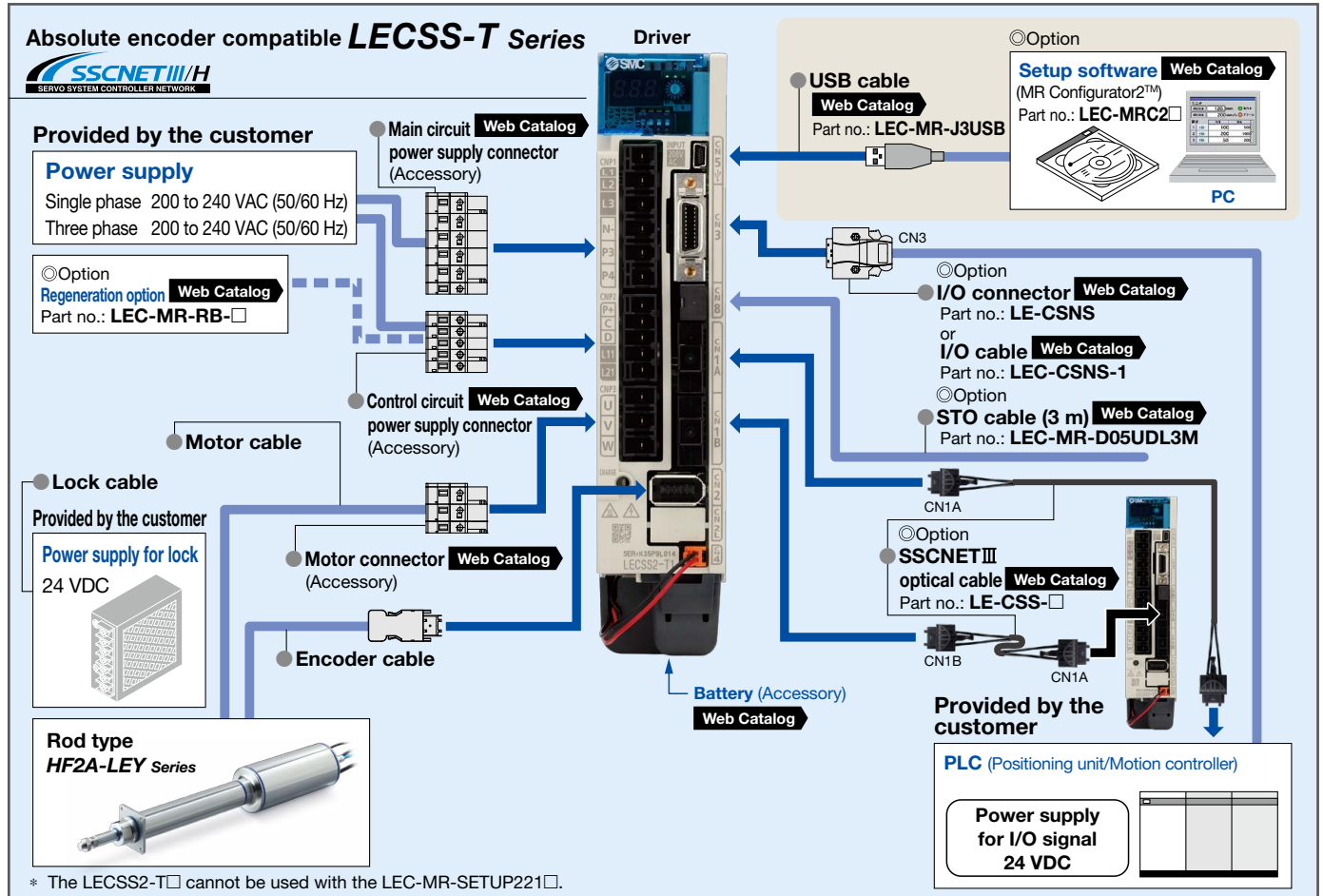

Electric Actuator

Dust-tight/Water-jet-proof (IP69K Equivalent)

Rod Type

Dust-tight/Water-jet-proof (IP69K Equivalent)

Rod Type *HF2A-LEY Series*

AC Servo Motor

p. 14

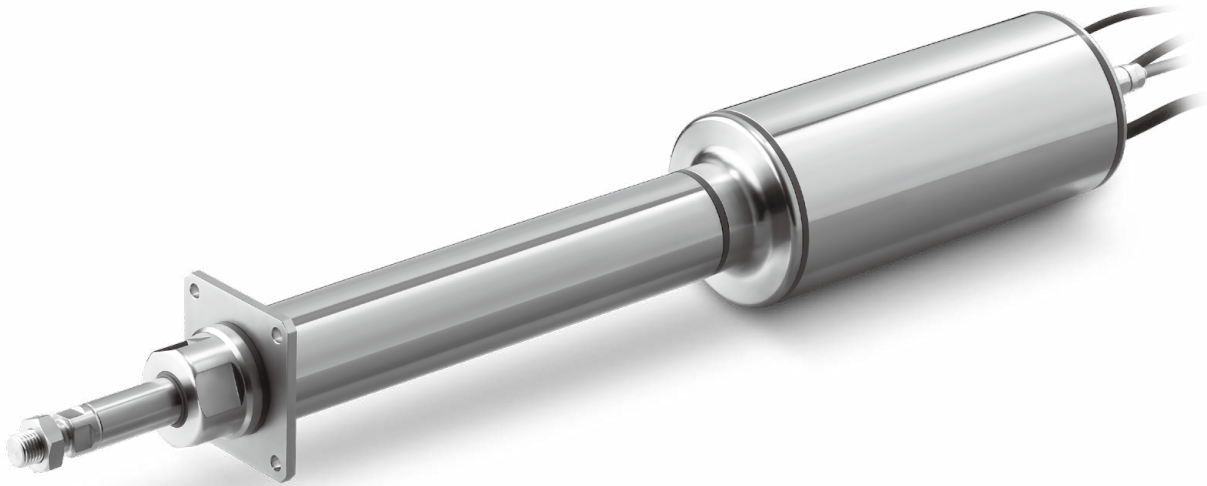

CONTENTS

Model Selection	p. 7
How to Order	p. 14
Specifications	p. 15
Weight	p. 15
Dimensions	p. 17
Accessory Mounting Brackets	p. 18
Specific Product Precautions	p. 19
CE/UKCA/UL-compliance List	p. 21

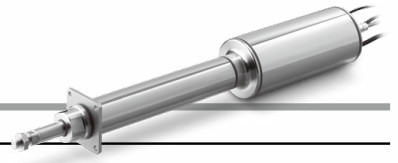

Selection Procedure

Positioning Control Selection Procedure



Selection Example

Operating conditions

- Workpiece mass: 16 [kg]
- Speed: 300 [mm/s]
- Acceleration/Deceleration: 5000 [mm/s²]
- Stroke: 300 [mm]
- Workpiece mounting condition: Vertical upward downward transfer

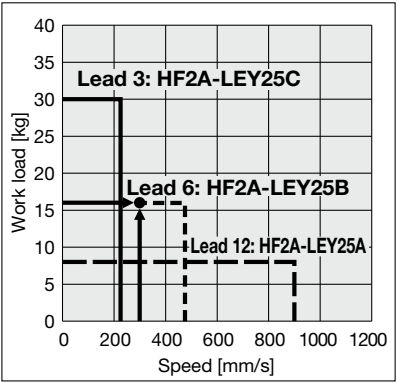

<Speed-Vertical work load graph> (HF2A-LEY25)

Step 1 Check the work load-speed. <Speed-Vertical work load graph>
Select a model based on the workpiece mass and speed while referencing the speed-vertical work load graph.

Selection example) The **HF2A-LEY25B** can be temporarily selected as a possible candidate based on the graph shown on the right side.

* It is necessary to mount a guide outside the actuator when used for horizontal transfer. When selecting the target model, refer to the horizontal work load in the specifications on pages 15 and 16 and the precautions.

The regeneration option may be necessary. Refer to pages 9 and 10 for the "Required Conditions for the Regeneration Option."

Step 2 Check the cycle time.

Calculate the cycle time using the following calculation method.

Cycle time:

T can be found from the following equation.

$$T = T1 + T2 + T3 + T4 \text{ [s]}$$

•T1: Acceleration time and T3: Deceleration time can be found by the following equation.

$$T1 = V/a1 \text{ [s]} \quad T3 = V/a2 \text{ [s]}$$

•T2: Constant speed time can be found from the following equation.

$$T2 = \frac{L - 0.5 \cdot V \cdot (T1 + T3)}{V} \text{ [s]}$$

•T4: Settling time varies depending on the motor type and load. The value below is recommended.

$$T4 = 0.05 \text{ [s]}$$

L : Stroke [mm] ... (Operating condition)
 V : Speed [mm/s] ... (Operating condition)
 a1: Acceleration [mm/s²] ... (Operating condition)
 a2: Deceleration [mm/s²] ... (Operating condition)

T1: Acceleration time [s] ... Time until reaching the set speed
 T2: Constant speed time [s] ... Time while the actuator is operating at a constant speed
 T3: Deceleration time [s] ... Time from the beginning of the constant speed operation to stop
 T4: Settling time [s] ... Time until positioning is completed

Calculation example)

T1 to T4 can be calculated as follows.

$$T1 = V/a1 = 300/5000 = 0.06 \text{ [s]}, \quad T3 = V/a2 = 300/5000 = 0.06 \text{ [s]}$$

$$T2 = \frac{L - 0.5 \cdot V \cdot (T1 + T3)}{V} = \frac{300 - 0.5 \cdot 300 \cdot (0.06 + 0.06)}{300} = 0.94 \text{ [s]}$$

$$T4 = 0.05 \text{ [s]}$$

The cycle time can be found as follows.

$$T = T1 + T2 + T3 + T4 = 0.06 + 0.94 + 0.06 + 0.05 = 1.11 \text{ [s]}$$

Based on the above calculation result, the **HF2A-LEY25DS2B-300-R** should be selected.

Selection Procedure

Force Control Selection Procedure



* The duty ratio is a ratio of the operation time in one cycle.

Selection Example

Operating conditions

- Mounting condition: Horizontal (pushing)
- Attachment weight: 0.5 [kg]
- Force: 255 [N]
- Duty ratio: 60 [%]
- Speed: 100 [mm/s]
- Stroke: 300 [mm]

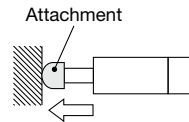

Step 1 Check the duty ratio.

<Conversion table of force–duty ratio>

Select the [Force] from the duty ratio while referencing the conversion table of force–duty ratio.

Selection example)

Based on the table below,

- Duty ratio: 10 [%]

Torque limit/Command value will be 30 [%].

<Conversion table of force–duty ratio>

(HF2A-LEY25/AC Servo motor)

Ambient temperature	Torque limit/Command value [%]	Duty ratio [%]	Continuous pushing time [min]
35°C or less	15 or less	100	No restriction
	30	20	1.5 or less
40°C	30	10	1.5 or less

* [Torque limit/Command value [%]] is the set value for the driver.

* [Continuous pushing time] is the time that the actuator can continuously keep pushing.

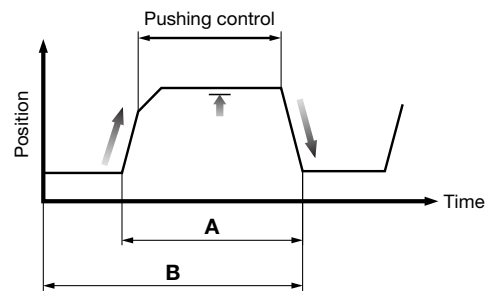

$$\text{Duty ratio} = A/B \times 100 \text{ [%]}$$

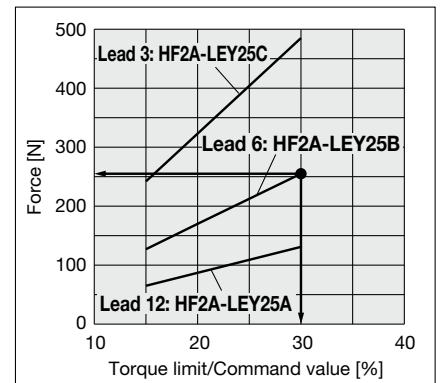

<Force conversion graph>
(HF2A-LEY25)

Step 2 Check the force.

<Force conversion graph>

Select a model based on the torque limit/command value and pushing force while referencing the force conversion graph.

Selection example)

Based on the graph shown on the right side,

- Torque limit/Command value: 30 [%]
- Force: 255 [N]

The **HF2A-LEY25B** can be temporarily selected as a possible candidate.

Step 3 Check the lateral load on the rod end.

<Graph of allowable lateral load on the rod end>

Confirm the allowable lateral load on the rod end of the actuator: HF2A-LEY25B, which has been selected temporarily while referencing the graph of allowable lateral load on the rod end.

Selection example)

Based on the graph shown on the right side,

- Attachment weight: 0.5 [kg] \approx 5 [N]
- Product stroke: 300 [mm]

The lateral load on the rod end is in the allowable range.

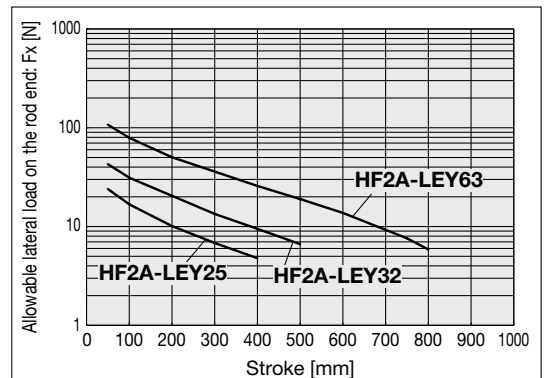

<Graph of allowable lateral load on the rod end>

Based on the above calculation result, the **HF2A-LEY25DS2B-300□-R□** should be selected.

* For pushing operations, check the list of applicable drivers.
(Refer to the **Web Catalog**.)

HF2A-LEY Series

AC Servo Motor

Size **25, 32, 63**

Dust-tight/Water-jet-proof (IP69K Equivalent)

Speed-Vertical Work Load Graph/Required Conditions for the Regeneration Option

HF2A-LEY25DS2/T6

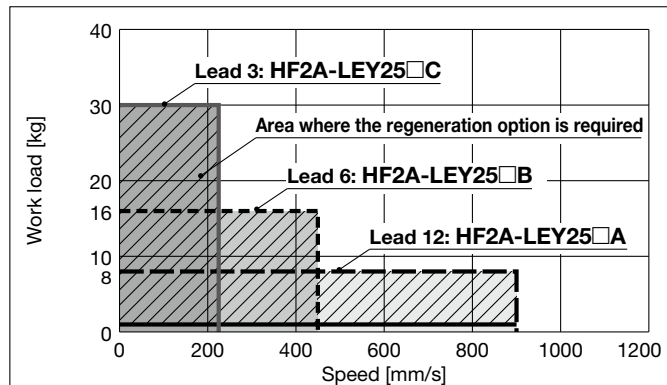

Required conditions for the regeneration option

* The regeneration option is required when using the product above the regeneration line in the graph. (It must be ordered separately.)

Regeneration Option Models

Size	Model
HF2A-LEY25□	LEC-MR-RB-032
HF2A-LEY32□	LEC-MR-RB-032
HF2A-LEY63□	LEC-MR-RB-12

HF2A-LEY32DS3/T7

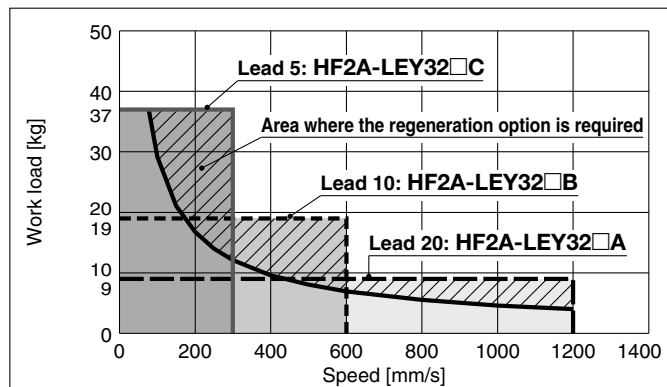

HF2A-LEY63DS4/T8

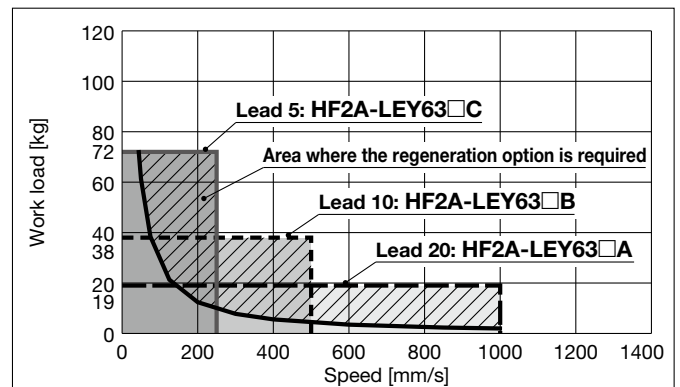

Speed-Horizontal Work Load Graph/Required Conditions for the Regeneration Option

HF2A-LEY25DS2/T6

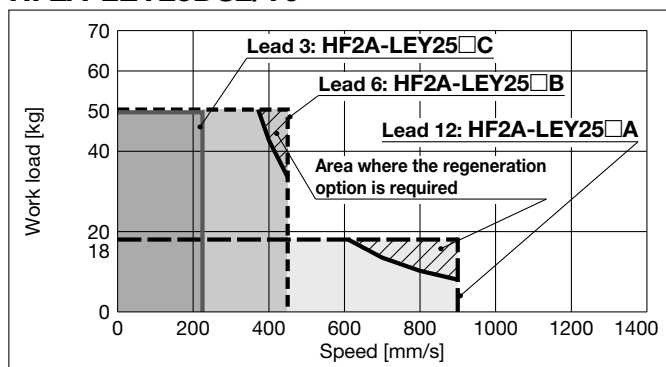

Required conditions for the regeneration option

* The regeneration option is required when using the product above the regeneration line in the graph. (It must be ordered separately.)

Regeneration Option Models

Size	Model
HF2A-LEY25□	LEC-MR-RB-032
HF2A-LEY32□	LEC-MR-RB-032
HF2A-LEY63□	—

HF2A-LEY32DS3/T7

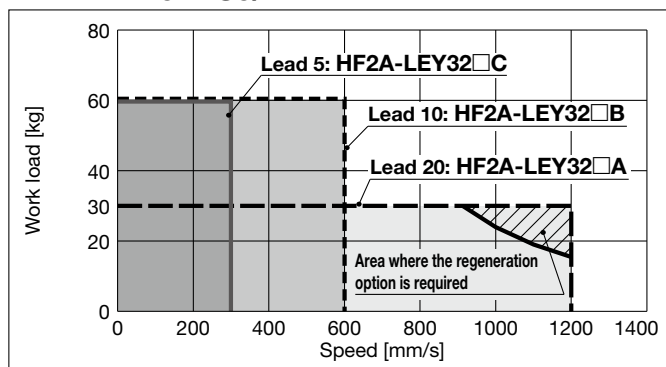

HF2A-LEY63DS4/T8

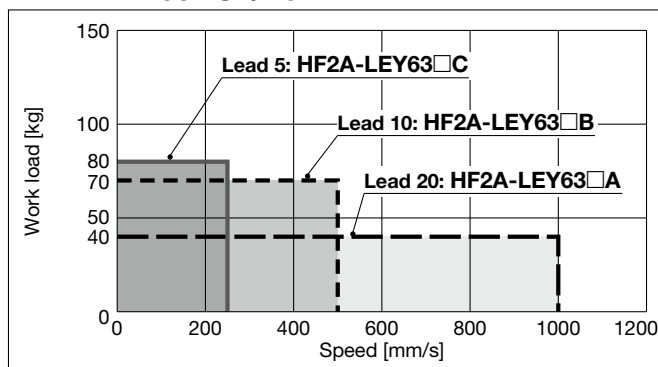

Allowable Stroke Speed

Model	AC servo motor	Lead		Stroke [mm]													
		Symbol	[mm]	50	100	150	200	250	300	350	400	450	500	600	700	800	
HF2A-LEY25DS2/T6	100 W /□40	A	12	900						600		—	—	—	—	—	—
		B	6	450						300		—	—	—	—	—	
		C	3	225						150		—	—	—	—	—	
		(Motor rotation speed)		(4500 rpm)						(3000 rpm)		—	—	—	—	—	
HF2A-LEY32DS3/T7	200 W /□60	A	20	1200						800			—	—	—		
		B	10	600						400			—	—	—		
		C	5	300						200			—	—	—		
		(Motor rotation speed)		(3600 rpm)						(2400 rpm)			—	—	—		
HF2A-LEY63DS4/T8	400 W /□60	A	20	1000						800			600	500			
		B	10	500						400			300	250			
		C	5	250						200			150	125			
		(Motor rotation speed)		(3000 rpm)						(2400 rpm)			(1800 rpm)	(1500 rpm)			

HF2A-LEY Series

AC Servo Motor

Size **25, 32, 63**

Dust-tight/Water-jet-proof (IP69K Equivalent)

Force Conversion Graph (Guide) for the LECSA

HF2A-LEY25DS2

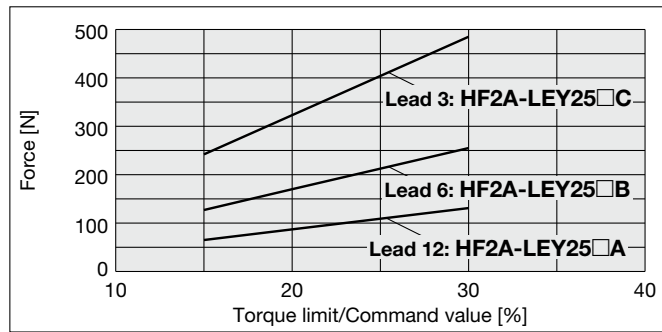

Ambient temperature	Torque limit/Command value [%]	Duty ratio [%]	Continuous pushing time [min]
35°C or less	15 or less	100	No restriction
	30	20	1.5 or less
40°C	30	10	1.5 or less

HF2A-LEY32DS3

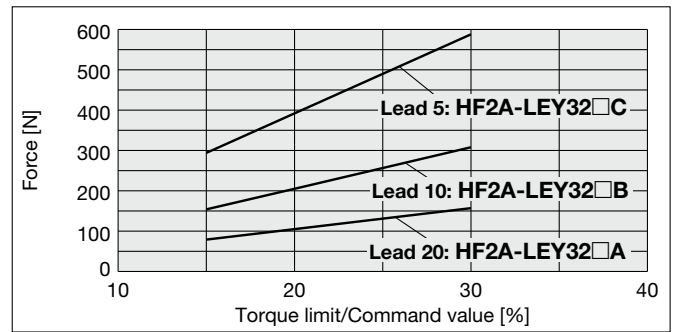

Ambient temperature	Torque limit/Command value [%]	Duty ratio [%]	Continuous pushing time [min]
40°C	15 or less	100	No restriction
	30	40	1.5 or less

HF2A-LEY63DS4

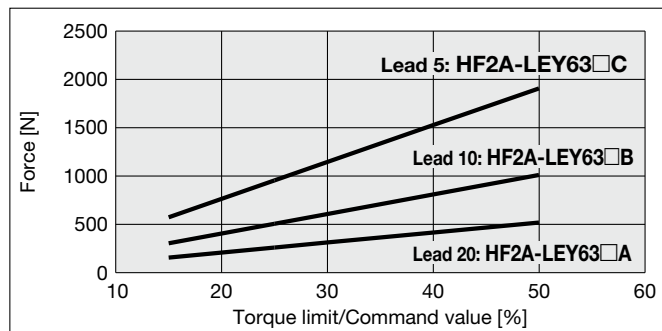

Ambient temperature	Torque limit/Command value [%]	Duty ratio [%]	Continuous pushing time [min]
40°C	15 or less	100	No restriction
	30	40	1.5 or less
	40	20	0.5 or less
	50	10	0.16 or less

Force Conversion Graph (Guide) for the LECS□-T

HF2A-LEY25DT6

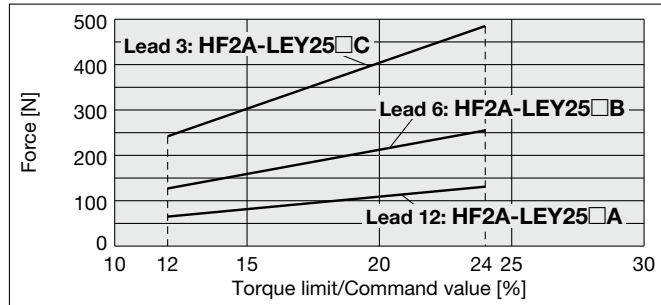

Ambient temperature	Torque limit/Command value [%]	Duty ratio [%]	Continuous pushing time [min]
35°C or less	12 or less	100	No restriction
	24	20	1.5 or less
40°C	24	10	1.5 or less

HF2A-LEY32DT7

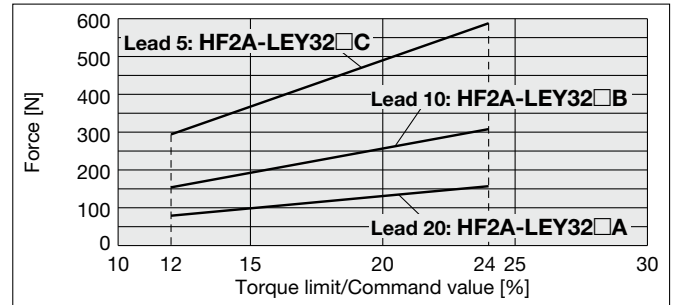

Ambient temperature	Torque limit/Command value [%]	Duty ratio [%]	Continuous pushing time [min]
40°C	12 or less	100	No restriction
	24	40	1.5 or less

HF2A-LEY63DT8

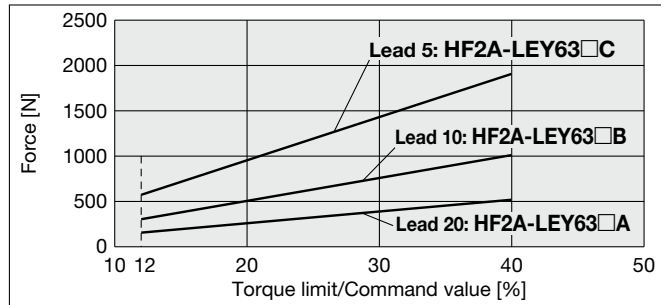

Ambient temperature	Torque limit/Command value [%]	Duty ratio [%]	Continuous pushing time [min]
40°C	12 or less	100	No restriction
	24	40	1.5 or less
	32	20	0.5 or less
	40	10	0.16 or less

HF2A-LEY Series

AC Servo Motor

Size **25, 32, 63**

Dust-tight/Water-jet-proof (IP69K Equivalent)

Graph of Allowable Lateral Load on the Rod End (Guide)

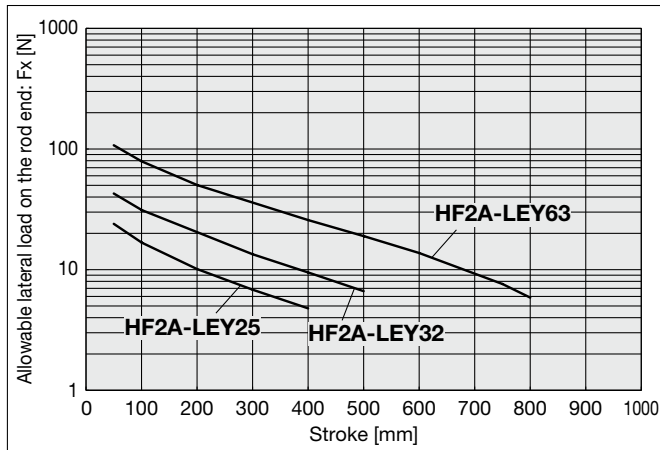

[Stroke] = [Product stroke] + [Distance from the rod end to the center of gravity of the workpiece]

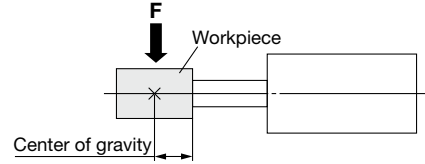

Rod Displacement: δ [mm]

Stroke \ Size	50	100	150	200	250	300	350	400	450	500	600	700	800
25	±0.4	±0.6	±0.9	±1.1	±1.4	±1.6	±1.8	±2.1	—	—	—	—	—
32	±0.3	±0.5	±0.6	±0.8	±1.0	±1.1	±1.3	±1.4	±1.6	±1.8	—	—	—
63	±0.3	±0.5	±0.7	±0.8	±1.0	±1.1	±1.3	±1.4	±1.6	±1.8	±2.1	±2.4	±2.7

* The values without a load are shown.

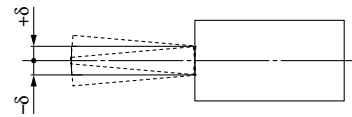

Non-rotating Accuracy of Rod

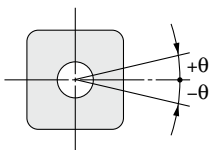

Size	Non-rotating accuracy θ
25	±1.2°
32	±0.8°
63	±0.7°

* Avoid using the electric actuator in such a way that rotational torque would be applied to the piston rod. Failure to do so may result in the deformation of the non-rotating guide, play in the internal guide, or an increase in the sliding resistance.

Rod Type Dust-tight/Water-jet-proof (IP69K Equivalent)

HF2A-LEY Series HF2A-LEY25, 32, 63 Size 25, 32, 63

How to Order

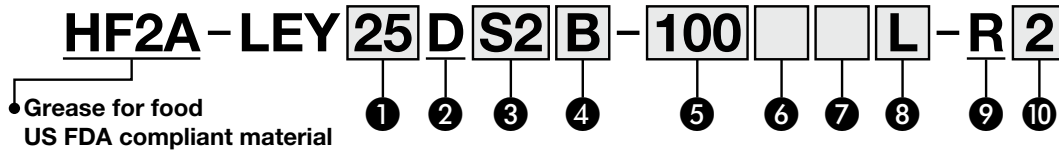

① Size

25
32
63

② Motor mounting position

D	In-line
----------	---------

③ Motor type

Symbol	Type	Output [W]	Size	Compatible drivers*3
S2 *1	AC servo motor (Incremental encoder)	100	25	LECSA □ - S1
S3		200	32	LECSA □ - S3
S4		400	63	LECSA2 - S4
T6 *2	AC servo motor (Absolute encoder)	100	25	LECS □2- T5
T7		200	32	LECS □2- T7
T8		400	63	LECS □2- T8

*1 For motor type S2, the compatible driver part number suffix is S1.

*2 For motor type T6, the compatible driver part number suffix is T5.

*3 For details on the driver, refer to the **Web Catalog**. The driver should be ordered separately.

④ Lead [mm]

Size	25	32	63
A	12	20	20
B	6	10	10
C	3	5	5

⑤ Stroke [mm]

50	50
to	to
800	800

* For details, refer to the applicable stroke table below.

⑥ Motor option

Nil	Without option
B	With lock

⑦ Rod end thread

Nil	Rod end female thread
M	Rod end male thread (1 rod end nut is included.)

⑧ Mounting

L	Foot bracket
F	Rod flange

* Do not mount the product using a rod flange when mounting horizontally and fixed at one end.

⑨ Cable type*1

R	Robotic cable
----------	---------------

*1 A motor cable and encoder cable are included with the product. (A lock cable is also included if motor option "B: With lock" is selected.)

⑩ Cable length*1 [m]

2	2
5	5
A	10

*1 The length of the motor, encoder, and lock cables are the same.

Applicable Stroke Table

●: Standard

Size	Stroke [mm]	50	100	150	200	250	300	350	400	450	500	600	700	800	Manufacturable stroke range
25		●	●	●	●	●	●	●	●	—	—	—	—	—	50 to 400
32		●	●	●	●	●	●	●	●	●	●	—	—	—	50 to 500
63		●	●	●	●	●	●	●	●	●	●	●	●	●	50 to 800

* Please contact SMC for non-standard strokes as they are produced as special orders.

HF2A-LEY Series

AC Servo Motor Size **25, 32, 63**

Specifications: LECSA□

* Refer to the next page for the LECS□2-T.

Model		HF2A-LEY25DS2			HF2A-LEY32DS3			HF2A-LEY63DS4							
Actuator specifications	Work load [kg]	Horizontal*1	18	50	50	30	60	60	40	70	80				
		Vertical	8	16	30	9	19	37	19	38	72				
	Force [N]*2 (Set value: 15 to 30%)*10		65 to 131	127 to 255	242 to 485	79 to 157	154 to 308	294 to 588	156 to 521	304 to 1012	573 to 1910				
	Max. speed [mm/s]	Stroke range	Up to 300	900	450	225	1200	600	300	1000	500	250			
			305 to 400	600	300	150									
			405 to 500	—	—	—	800	400	200						
			Up to 500	—	—	—	—	—	—						
			505 to 600	—	—	—	—	—	—				800	400	200
			605 to 700	—	—	—	—	—	—				600	300	150
	705 to 800	—	—	—	—	—	—	500	250	125					
	Pushing speed [mm/s]*4		35 or less			30 or less									
	Max. acceleration/deceleration [mm/s ²]					5000									
	Positioning repeatability [mm]					±0.01									
	Lost motion [mm]*5					0.05 or less									
	Lead [mm]		12	6	3	20	10	5	20	10	5				
Impact/Vibration resistance [m/s ²]*6					50/20										
Actuation type					Ball screw										
Enclosure*9					IP69K equivalent										
Operating temperature range [°C]					5 to 40										
Operating humidity range [%RH]					90 or less (No condensation)										
Regeneration option					May be required depending on speed and work load (Refer to pages 9 and 10.)										
Motor output/Size		100 W/□40			200 W/□60			400 W/□60							
Motor type					AC servo motor (100/200 VAC)			AC servo motor (200 VAC)							
Encoder					Motor type S2, S3, S4: Incremental 17-bit encoder (Resolution: 131072 p/rev)										
Power [W]*7		Max. power 445			Max. power 724			Max. power 1275							
Type*8					Non-magnetizing lock										
Holding force [N]		131	255	485	157	308	588	313	607	1146					
Power [W] at 20°C		6.3						7.9							
Rated voltage [V]					24 VDC ⁰ / _{-10%}										

*1 This is the max. value of the horizontal work load. An external guide is necessary to support the load (Friction coefficient of guide: 0.1 or less). The actual work load changes according to the condition of the external guide. Confirm the load using the actual device.

*2 The force setting range (set values for the driver) for the force control with the torque control mode. The force and duty ratio change according to the set value. Set it while referencing the "Force Conversion Graph" on page 11.

When the control equivalent to the pushing operation of the JXC51/61 series controller is performed, select "□" for the motor type and the LECS2-T or LECSB2-T driver.

The point table no. input method is used for the LECSB2-T. When selecting the LECS2-T, combine it with a Simple Motion module (manufactured by Mitsubishi Electric Corporation) which has a pushing operation function.

*3 The allowable speed changes according to the stroke. Set the number of rotations according to speed.

*4 The allowable collision speed for collision with the workpiece with the torque control mode

*5 A reference value for correcting errors in reciprocal operation

*6 Impact resistance: No malfunction occurred when the actuator was tested with a drop tester in both an axial direction and a perpendicular direction to the lead screw. (The test was performed with the actuator in the initial state.)

Vibration resistance: No malfunction occurred in a test ranging between 45 to 2000 Hz. The test was performed in both an axial direction and a perpendicular direction to the lead screw. (The test was performed with the actuator in the initial state.)

*7 Indicates the max. power during operation (including the driver) When selecting the power supply capacity, refer to the power supply capacity in the operation manual of each driver.

*8 Only when motor option "With lock" is selected

*9 The cable is equivalent to IP67.

*10 For motor type S4, the set value is 15 to 50%.

Weight

Product Weight (Cables are not included.)

[kg]

Series	HF2A-LEY25									HF2A-LEY32									
Stroke [mm]	50	100	150	200	250	300	350	400	450	50	100	150	200	250	300	350	400	450	500
Motor type	Incremental encoder	3.75	3.98	4.21	4.45	4.68	4.91	5.14	5.38	6.46	6.78	7.11	7.44	7.77	8.09	8.42	8.75	9.07	9.40

Series	HF2A-LEY63													
Stroke [mm]	50	100	150	200	250	300	350	400	450	500	600	700	800	
Motor type	Incremental encoder	9.21	9.73	10.25	10.78	11.30	11.82	12.34	12.86	13.39	13.94	14.98	16.00	17.04

Additional Weight

[kg]

Size		25	32	63
Motor option	With lock	0.4	0.59	0.59
Rod end thread	Rod end male thread (including a rod end nut)	0.05	0.05	0.09
Mounting	Foot bracket (including mounting screws)	0.43	0.76	0.97

Cable Weight

[kg]

Type	Length [mm]		
	2	5	10
Motor cable	0.18	0.40	0.80
Encoder cable	0.22	0.60	1.20
Lock cable	0.08	0.20	0.40

Specifications: LECS□2-T

Model		HF2A-LEY25DT6				HF2A-LEY32DT7			HF2A-LEY63DT8			
Actuator specifications	Work load [kg]	Horizontal*1	18	50	50	30	60	60	40	70	80	
		Vertical	8	16	30	9	19	37	19	38	72	
	Force [N]*2 (Set value: 12 to 24%)*3		65 to 131	127 to 255	242 to 485	79 to 157	154 to 308	294 to 588	156 to 521	304 to 1012	573 to 1910	
	Max. speed [mm/s]	Stroke range	Up to 300	900	450	225	1200	600	300	1000	500	250
			305 to 400	600	300	150						
			405 to 500	—	—	—	800	400	200			
			Up to 500	—	—	—	—	—	—			
			505 to 600	—	—	—	—	—	—	800	400	200
			605 to 700	—	—	—	—	—	—	600	300	150
	705 to 800	—	—	—	—	—	—	500	250	125		
Pushing speed [mm/s]*5		35 or less				30 or less						
Max. acceleration/deceleration [mm/s²]							5000					
Positioning repeatability [mm]		±0.01										
Lost motion [mm]*6		0.05 or less										
Lead [mm]		12	6	3	20	10	5	20	10	5		
Impact/Vibration resistance [m/s²]*7		50/20										
Actuation type		Ball screw										
Enclosure*11		IP69K equivalent										
Operating temperature range [°C]		5 to 40										
Operating humidity range [%RH]		90 or less (No condensation)										
Regeneration option		May be required depending on speed and work load (Refer to pages 9 and 10.)										
Motor output/Size		100 W/□40			200 W/□60			400 W/□60				
Motor type		AC servo motor (200 VAC)										
Encoder*10		Motor type T6, T7, T8: Absolute 22-bit encoder (Resolution: 4194304 p/rev) (For LECSB2-T□, LECSS2-T□, LECSN2-T□) Motor type T6, T7, T8: Absolute 18-bit encoder (Resolution: 262144 p/rev) (For LECSC-T□)										
Power [W]*8		Max. power 445			Max. power 724			Max. power 1275				
Type*9		Non-magnetizing lock										
Holding force [N]		131	255	485	157	308	588	313	607	1146		
Power [W] at 20°C		6.3			7.9							
Rated voltage [V]		24 VDC ⁰ / _{-10%}										

*1 This is the max. value of the horizontal work load. An external guide is necessary to support the load (Friction coefficient of guide: 0.1 or less). The actual work load changes according to the condition of the external guide. Confirm the load using the actual device.
 *2 The force setting range (set values for the driver) for the force control with the torque control mode. Set it while referencing the "Force Conversion Graph (Guide)" on page 12. The drivers applicable to the pushing operation are "LECSB2-T" and "LECSS2-T." The LECSB2-T is only applicable when the control method is positioning. The point table is used to set the pushing operation settings. To set the pushing operation settings, an additional dedicated file (pushing operation extension file) must be downloaded separately to be used with the setup software (MR Configurator2™: LEC-MRC2□). Please download this dedicated file from the SMC website: <https://www.smcworld.com>
 When selecting the LECSS2-T, combine it with upper level equipment (such as the Simple Motion module manufactured by Mitsubishi Electric Corporation) which has a pushing operation function.
 ** For customer-provided PLC and motion controller setting and usage instructions, confirm with the retailer or manufacturer.

*3 For motor type T8, the set value is 12 to 40%.
 *4 The allowable speed changes according to the stroke.
 *5 The allowable collision speed for collision with the workpiece with the torque control mode
 *6 A reference value for correcting errors in reciprocal operation
 *7 Impact resistance: No malfunction occurred when the actuator was tested with a drop tester in both an axial direction and a perpendicular direction to the lead screw. (The test was performed with the actuator in the initial state.)
 Vibration resistance: No malfunction occurred in a test ranging between 45 to 2000 Hz. The test was performed in both an axial direction and a perpendicular direction to the lead screw. (The test was performed with the actuator in the initial state.)
 *8 Indicates the max. power during operation (including the driver) When selecting the power supply capacity, refer to the power supply capacity in the operation manual of each driver.
 *9 Only when motor option "With lock" is selected
 *10 The resolution will change depending on the driver type.
 *11 The cable is equivalent to IP67.

Weight

Product Weight (Cables are not included.)

[kg]

Series		HF2A-LEY25								HF2A-LEY32									
Stroke [mm]		50	100	150	200	250	300	350	400	50	100	150	200	250	300	350	400	450	500
Motor type	Absolute encoder	3.79	4.02	4.25	4.49	4.72	4.95	5.18	5.42	6.36	6.68	7.01	7.34	7.67	7.99	8.32	8.65	8.97	9.30

Series		HF2A-LEY63												
Stroke [mm]		50	100	150	200	250	300	350	400	450	500	600	700	800
Motor type	Absolute encoder	9.21	9.73	10.25	10.78	11.30	11.82	12.34	12.86	13.39	13.94	14.98	16.00	17.04

Additional Weight

[kg]

Size		25	32	63
Motor option	With lock	0.4	0.59	0.59
Rod end thread	Rod end male thread (including a rod end nut)	0.05	0.05	0.09
Mounting	Foot bracket (including mounting screws)	0.43	0.76	0.97

Cable Weight

[kg]

Type	Length [mm]		
	2	5	10
Motor cable	0.18	0.40	0.80
Encoder cable	0.22	0.60	1.20
Lock cable	0.08	0.20	0.40

HF2A-LEY Series

AC Servo Motor

Size **25, 32, 63**

Dimensions

Foot bracket: HF2A-LEY□D□□-□□□L-R□

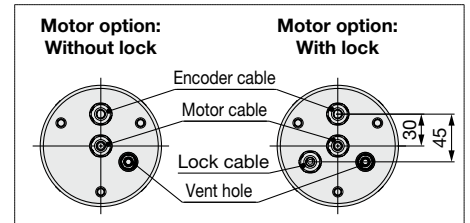
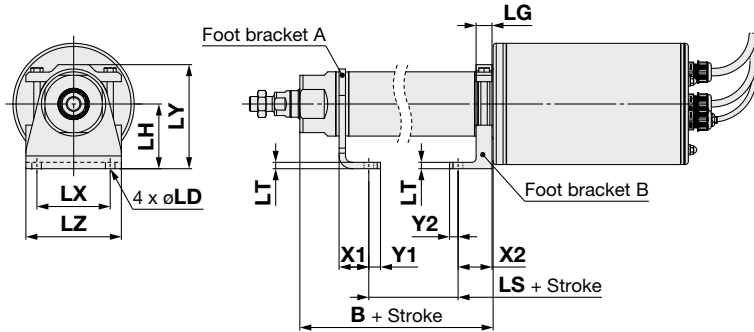

[mm]

Size	B	LS	LD	LG	LT	LX	LZ	LH	LY	X1	X2	Y1	Y2
25	136.5	57	6.6	12	5	62	79	53	84	23	23	9	6
32	183	85	9	15	6	69	90	64	101	28	32	11	8
63	204	105	9	15	10	90	108	61	106	27	32	8	8

Rod flange: HF2A-LEY□D□□-□□□F-R□

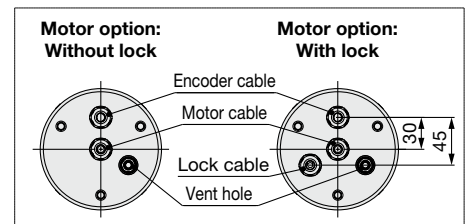
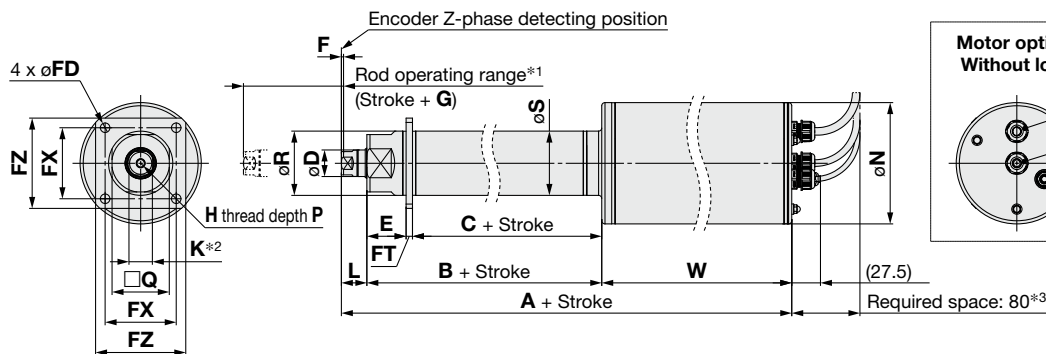

- *1 This is the range within which the rod can move. Make sure that workpieces mounted on the rod do not interfere with other workpieces or the facilities around the rod.
- *2 The direction of width across flats (□Q, □K) differs depending on the products.
- *3 The amount of space required to connect the various cables and mount the product. Provide this amount of space for cable handling.

[mm]

Size	A		W		B	C	D	E	F	G	H	P	L	N	K	Q	R	S	FD	FT	FX	FZ
	Without lock	With lock	Without lock	With lock																		
25	332	369	174	211	136.5	100	20	31.5	2	4	M8 x 1.25	13	21.5	89.5	17	41	49	49	6.6	5	58	73
32	392	420	185	213	183	140	25	37	2	4	M8 x 1.25	13	24	114.5	22	54	60.5	60.5	9	6	67	85
63	455	483	219	247	204	156	40	38	4	8	M16 x 2.0	21	32	114.5	36	70	76.5	76.5	11	10	80	100

- * The L measurement is when the unit is in the original position. At this position, F [mm] at the end.

End male thread: HF2A-LEY□D□□-□□□M□-R□

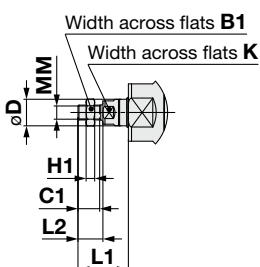

[mm]

Size	B1	C1	D	H1	K	L1	L2	MM
25	22	20.5	20	8	17	45	23.5	M14 x 1.5
32	22	20.5	25	8	22	47.5	23.5	M14 x 1.5
63	27	26	40	11	36	63	31	M18 x 1.5

- * The L1 measurement is when the unit is in the original position. At this position, F [mm] at the end.

HF2A-LEY Series

Accessory Mounting Brackets

Accessory Brackets

Rod End Nut

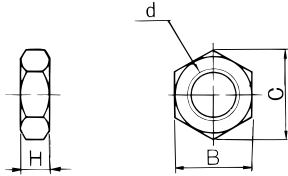

Material: Stainless steel 304
[mm]

Part no.	Applicable size	d	H	B	C
NT-04SUS	25, 32	M14 x 1.5	8	22	25.4
NT-05SUS	63	M18 x 1.5	11	27	31.2



HF2A-LEY Series Specific Product Precautions 1

Be sure to read this before handling the products. Refer to the back cover for safety instructions. For electric actuator precautions, refer to the “Handling Precautions for SMC Products” and the “Operation Manual” on the SMC website: <https://www.smcworld.com>

Design / Selection

Warning

- Do not apply a load in excess of the specification limits.**
Select a suitable actuator by work load and allowable lateral load on the rod end. If a load in excess of the specification limits is applied to the piston rod, the generation of play in the piston rod sliding parts, reduced accuracy, etc., may occur and adversely affect the operation and service life of the product.
- Do not use the product in applications where excessive external force or impact force is applied to it.**
This can cause a malfunction.

Handling

Caution

- To conduct a pushing operation, be sure to set the product to force/speed control, and use the product within the specified pushing speed range for each series.**
Do not allow the piston rod to hit the workpiece and end of the stroke in the position control. The lead screw, bearing and internal stopper may be damaged and lead to malfunction.
- For pushing operations, the maximum torque value of the motor to be used should be set to 90% or less (150% or less for the HF2A-LEY63) of the rated torque of the reference motor.**
Failure to do so may result in damage or malfunction.
- The maximum speed of this actuator is affected by the product stroke.**
Check the model selection section of the catalog.
- Do not apply a load, impact, or resistance in addition to the transferred load during return to origin.**
Additional force will cause the displacement of the origin position.
- Do not scratch or dent the sliding parts of the piston rod by bumping them or placing objects on them.**
The piston rod and guide rod are manufactured to precise tolerances, so even a slight deformation may result in a malfunction.
- When an external guide is used, connect it in such a way that no impact or load is applied to it.**
Use a freely moving connector (such as a floating joint).
- Do not operate by fixing the piston rod and moving the actuator body.**
Excessive load will be applied to the piston rod, resulting in damage to the actuator and a reduced service life of the product.
- If an abnormal temperature of the servo motor occurs, please consider reducing any of a torque limit/command value, duty ratio, or ambient temperature.**

Handling

Caution

- When an actuator is operated with one end fixed (flange type), a bending moment may act on the actuator due to vibration generated at the stroke end, which can damage the actuator. In such cases, install a mounting bracket to suppress the vibration of the actuator body or reduce the speed so that the actuator does not vibrate at the stroke end.**
Also, use a mounting bracket when moving the actuator body or when a long stroke actuator is mounted horizontally and fixed at one end.
- Avoid using the electric actuator in such a way that rotational torque would be applied to the piston rod.**
Failure to do so may result in the deformation of the non-rotating guide, play in the internal guide, or an increase in the sliding resistance.
Refer to the table below for the approximate values of the allowable range of rotational torque.

Allowable rotational torque [N·m] or less	HF2A-LEY25	HF2A-LEY32	HF2A-LEY63
	1.1	1.4	2.8

When screwing a bracket or nut into the piston rod end, hold the flats of the end of the “socket” with a wrench (the piston rod should be fully retracted). Do not apply tightening torque to the non-rotating mechanism.

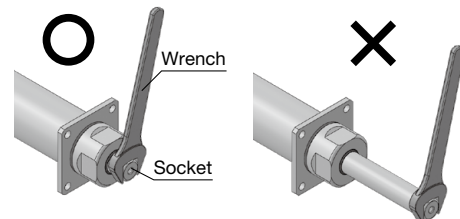

- Be sure to mount the tubing to the vent hole. (Applicable tubing size: O.D. $\phi 8$ x I.D. $\phi 6$)**
Place the end of the tubing in an area where it is not exposed to dust or water. The fitting uses our “KFG2H0806-G02-E.” Refer to the product catalog (CAT.ES50-41A) for compatible tubes and handling precautions.

Operating Environment

Warning

- Do not use the product in atmospheres of corrosive gases, chemicals*1, sea water, water vapor, or where there is direct contact with any of these.**
*1 Check section on washing and the product component list of the external materials used, and ensure compatibility with any chemicals used in the washing solution.
- When installing this product, do not use it in an environment where food in direct contact with this product is treated as a commodity.**
Use this product in an environment where this product does not come in contact with food or where food that comes in direct contact with this product is not treated as a commodity.



HF2A-LEY Series Specific Product Precautions 2

Be sure to read this before handling the products. Refer to the back cover for safety instructions. For electric actuator precautions, refer to the “Handling Precautions for SMC Products” and the “Operation Manual” on the SMC website: <https://www.smcworld.com>

Enclosure

⚠ Caution

IP69K is the degree of protection against dust and high-temperature/high-pressure water washdown specified in DIN 40050-9 and currently specified in ISO 20653 and JIS D 5020.

- * Test environment: Temperature 75 to 85°C, water pressure 8 to 10 MPa, flow rate 14 to 16 L/min, four nozzle angles (0°, 30°, 60°, 90°), turntable rotating at 4 to 6 r/min, test duration 30 seconds per surface at 10 to 15 cm distance.
- * IEC60529 specifies IP69 for general-purpose electrical products under the same conditions as IP69K except for a distance of 15 to 20 cm. The test conditions are IP69K > IP69.

1. While an IP69K compatible product offers protection against dust and high-temperature/high-pressure water, be sure to use the product within the ambient temperature range in the specifications.

2. IPX9K compliant products do not protect against fluids entering the product under all conditions.

When washing the product, follow the “Maintenance” section.

Mounting

⚠ Caution

1. When mounting workpieces or attachments to the piston rod end “socket,” hold the flats of the “socket” with a wrench so that the piston rod does not rotate. The bolt should be tightened within the specified torque range.

Failure to do so may cause play in the internal guide or an increase in the sliding resistance.

2. When mounting the product and/or a workpiece, tighten the mounting screws within the specified torque range.

Tightening the screws with a higher torque than recommended may result in a malfunction, while tightening with a lower torque can result in the displacement of the mounting position or, in extreme conditions, the actuator could become detached from its mounting position.

<HF2A-LEY Series>

Workpiece fixed/Rod end female thread

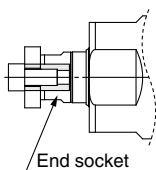

Model	Screw size	Max. tightening torque [N·m]	Max. screw-in depth [mm]	End socket width across flats [mm]
HF2A-LEY25	M8 x 1.25	12.5	13	17
HF2A-LEY32	M8 x 1.25	12.5	13	22
HF2A-LEY63	M16 x 2	106	21	36

Workpiece fixed/Rod end male thread (When “Rod end male thread” is selected.)

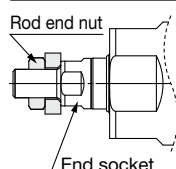

Model	Thread size	Max. tightening torque [N·m]	Effective thread length [mm]	End socket width across flats [mm]
HF2A-LEY25	M14 x 1.5	65.0	20.5	17
HF2A-LEY32	M14 x 1.5	65.0	20.5	22
HF2A-LEY63	M18 x 1.5	97.0	26	36

Maintenance

⚠ Warning

1. Rod cover assembly maintenance

Replace the rod cover assembly every 6 months or 800 km, whichever comes first. Be sure to apply screw-locking adhesive when mounting.

- * The life of the scraper varies depending on the operating environment, so determine it based on the actual operating conditions.
- * Recommended locking agent: Loctite 243

Rod Cover Assembly

Size	Part no.	Width across flats [mm]	Tightening torque [N·m]
25	LEY-D-11-1	41	14.8
32	LEY-D-11-2	54	40.5
63	LEY-D-11-3	70	80.0

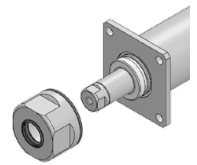

When replacing the rod cover assembly, apply grease to the part of the rod cover assembly shown in the figure below.

Grease Pack

Part no.	Note
GR-R-010	Grease for food processing equipment (10 g)

Size	Amount of grease [g]
25	0.12
32	0.15
63	0.23

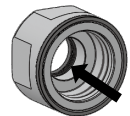

Apply to the inner surface of the scraper.

2. Piston rod maintenance

Apply grease to the piston rod every month, 100 km, or 0.5 million cycles, whichever comes first.

Grease Pack

Part no.	Note
GR-R-010	Grease for food processing equipment (10 g)

Size	Amount of grease [g/stroke per 100 mm]
25	0.6
32	0.7
63	1.1

3. Precautions for washing

The following conditions should be used when washing this product.

- Distance from the nozzle: 15 cm or more
- Water pressure: 8 MPa or less
- Water temperature: 75°C or less
- Water flow rate: 14 L/min or less

Use the lower value in comparison with the operating conditions of the washing machine.

Do not concentrate the washing area in one spot or fix the nozzle in one spot.



CE/UKCA/UL-compliance List

* For CE, UKCA, and UL-compliant products, refer to the tables below.

As of April 2024

■ Drivers “○”: Compliant

Compatible motor	Series	CE UK CA	UL LISTED	
			Compliance	Certification No. (File No.)
AC servo motor	LECSA	○	○	E466261
	LECSB-T	○	○	E466261
	LECS-C-T	○	○	E466261
	LECSN-T	○	○	E466261
	LECSS-T	○	○	E466261

■ Actuators “○”: Compliant

Compatible motor	Series	CE UK CA	UL LISTED	
			Compliance	Certification No. (File No.)
AC servo motor	HF2A-LEY	○	Not compliant with UL standards	—

* If the actuator is ordered separately, it does not comply with UL standards.

Safety Instructions

These safety instructions are intended to prevent hazardous situations and/or equipment damage. These instructions indicate the level of potential hazard with the labels of “**Caution**,” “**Warning**” or “**Danger**.” They are all important notes for safety and must be followed in addition to International Standards (ISO/IEC)*1), and other safety regulations.

 **Danger :** **Danger** indicates a hazard with a high level of risk which, if not avoided, will result in death or serious injury.

 **Warning:** **Warning** indicates a hazard with a medium level of risk which, if not avoided, could result in death or serious injury.

 **Caution:** **Caution** indicates a hazard with a low level of risk which, if not avoided, could result in minor or moderate injury.

*1) ISO 4414: Pneumatic fluid power - General rules and safety requirements for systems and their components
ISO 4413: Hydraulic fluid power - General rules and safety requirements for systems and their components
IEC 60204-1: Safety of machinery - Electrical equipment of machines - Part 1: General requirements
ISO 10218-1: Robots and robotic devices - Safety requirements for industrial robots - Part 1: Robots etc.

Warning

1. The compatibility of the product is the responsibility of the person who designs the equipment or decides its specifications.

Since the product specified here is used under various operating conditions, its compatibility with specific equipment must be decided by the person who designs the equipment or decides its specifications based on necessary analysis and test results. The expected performance and safety assurance of the equipment will be the responsibility of the person who has determined its compatibility with the product. This person should also continuously review all specifications of the product referring to its latest catalog information, with a view to giving due consideration to any possibility of equipment failure when configuring the equipment.

2. Only personnel with appropriate training should operate machinery and equipment.

The product specified here may become unsafe if handled incorrectly. The assembly, operation and maintenance of machines or equipment including our products must be performed by an operator who is appropriately trained and experienced.

3. Do not service or attempt to remove product and machinery/equipment until safety is confirmed.

1. The inspection and maintenance of machinery/equipment should only be performed after measures to prevent falling or runaway of the driven objects have been confirmed.
2. When the product is to be removed, confirm that the safety measures as mentioned above are implemented and the power from any appropriate source is cut, and read and understand the specific product precautions of all relevant products carefully.
3. Before machinery/equipment is restarted, take measures to prevent unexpected operation and malfunction.

4. Our products cannot be used beyond their specifications. Our products are not developed, designed, and manufactured to be used under the following conditions or environments. Use under such conditions or environments is not covered.

1. Conditions and environments outside of the given specifications, or use outdoors or in a place exposed to direct sunlight.
2. Use for nuclear power, railways, aviation, space equipment, ships, vehicles, military application, equipment affecting human life, body, and property, fuel equipment, entertainment equipment, emergency shut-off circuits, press clutches, brake circuits, safety equipment, etc., and use for applications that do not conform to standard specifications such as catalogs and operation manuals.
3. Use for interlock circuits, except for use with double interlock such as installing a mechanical protection function in case of failure. Please periodically inspect the product to confirm that the product is operating properly.

Caution

We develop, design, and manufacture our products to be used for automatic control equipment, and provide them for peaceful use in manufacturing industries.

Use in non-manufacturing industries is not covered.

Products we manufacture and sell cannot be used for the purpose of transactions or certification specified in the Measurement Act.

The new Measurement Act prohibits use of any unit other than SI units in Japan.

Limited warranty and Disclaimer/ Compliance Requirements

The product used is subject to the following “Limited warranty and Disclaimer” and “Compliance Requirements”.

Read and accept them before using the product.

Limited warranty and Disclaimer

1. The warranty period of the product is 1 year in service or 1.5 years after the product is delivered, whichever is first.*2)
Also, the product may have specified durability, running distance or replacement parts. Please consult your nearest sales branch.
2. For any failure or damage reported within the warranty period which is clearly our responsibility, a replacement product or necessary parts will be provided. This limited warranty applies only to our product independently, and not to any other damage incurred due to the failure of the product.
3. Prior to using SMC products, please read and understand the warranty terms and disclaimers noted in the specified catalog for the particular products.

*2) **Vacuum pads are excluded from this 1 year warranty.**

A vacuum pad is a consumable part, so it is warranted for a year after it is delivered.

Also, even within the warranty period, the wear of a product due to the use of the vacuum pad or failure due to the deterioration of rubber material are not covered by the limited warranty.

Compliance Requirements

1. The use of SMC products with production equipment for the manufacture of weapons of mass destruction (WMD) or any other weapon is strictly prohibited.
2. The exports of SMC products or technology from one country to another are governed by the relevant security laws and regulations of the countries involved in the transaction. Prior to the shipment of a SMC product to another country, assure that all local rules governing that export are known and followed.

Safety Instructions

Be sure to read the “Handling Precautions for SMC Products” (M-E03-3) and “Operation Manual” before use.

SMC Corporation

Akihabara UDX 15F,
4-14-1, Sotokanda, Chiyoda-ku, Tokyo 101-0021, JAPAN
Phone: 03-5207-8249 Fax: 03-5298-5362
<https://www.smcworld.com>
© 2024 SMC Corporation All Rights Reserved

Specifications are subject to change without prior notice and any obligation on the part of the manufacturer.

D-G