

Air Cylinder

ø20, ø25, ø32, ø40

RoHS

Overall length shortened

Approx. **1/3**

New A *foot type* and a *flange type* have been added.

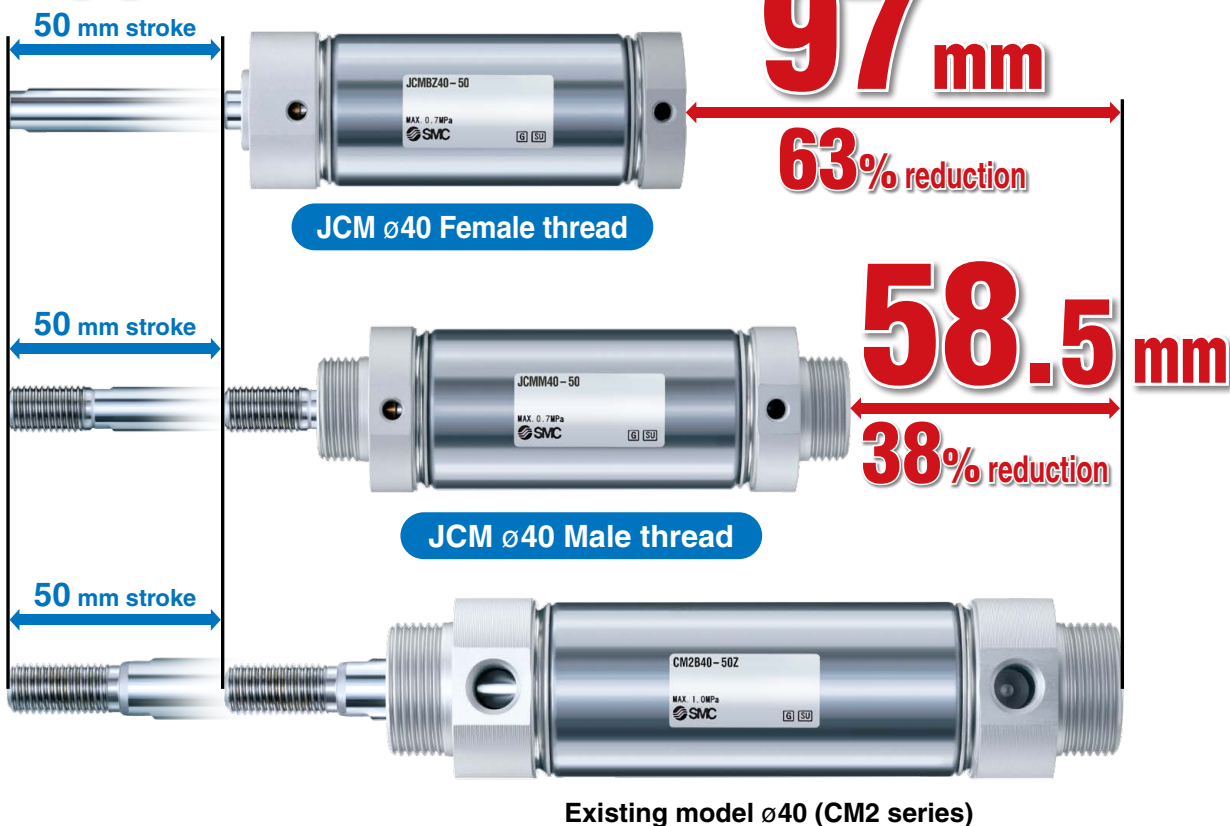

Height shortened

New mounting band for auto switch
Mounting height approx. **8 mm shorter**



Existing model

JCM

Max. **Weight 54% lighter**

0.69 kg → 0.32 kg

(Compared with the existing CM2B series model, ø40, 50 mm stroke)

JCM Series

SMC
CAT.ES20-237D



Various cover types available

Direct mounting is possible.

Basic (Female thread on rod cover)

Basic (Female thread on both covers)

Male thread on both covers

Male thread on rod cover

Mounting bracket

Foot type

Flange type

Examples

Rod side mounting

Head side mounting

Head side mounting

Rod side mounting

Overall length shortened

(Compared with the existing model (CM2 series))

<Basic (Female thread on rod cover), Female rod end>

Bore size [mm]	Existing model [mm]	JCM [mm]
ø20	116	47.5
ø25	120	50
ø32	122	50
ø40	154	57

<Male thread on both covers, Male rod end>

Bore size [mm]	Existing model [mm]	JCM [mm]
ø20	116	78
ø25	120	81.5
ø32	122	82
ø40	154	95.5

Port size: M5 and Rc NPT 1/8 available

With M5 port, the overall length is maximum 13 mm shorter (for ø20).



Weight reduced

(Compared with the existing CM2 series model, at 50 mm stroke (without magnet))

Bore size [mm]	Existing model [kg]	JCM*1 [kg]
ø20	0.18	0.10
ø25	0.27	0.14
ø32	0.36	0.18
ø40	0.69	0.32

*1 For basic type (female thread on rod cover) of the JCM series

Male and female rod ends available

Male and female threads available.

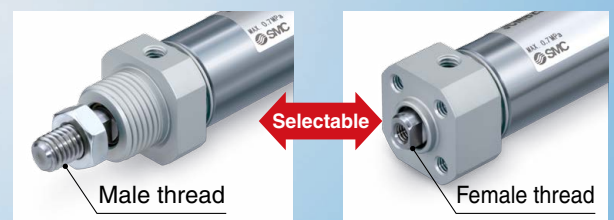

Lightweight and compact

Weight comparison between cylinders with a bracket

Flange bracket

Weight: Max. 37% reduction

Weight comparison (When mounted on the cylinder, 50 mm stroke) [kg]

Bore size [mm]	CM2	JCM	Weight difference	Reduction rate [%]
ø20	0.24	0.18	0.06	26
ø25	0.36	0.24	0.12	33
ø32	0.45	0.3	0.15	33
ø40	0.81	0.51	0.3	37

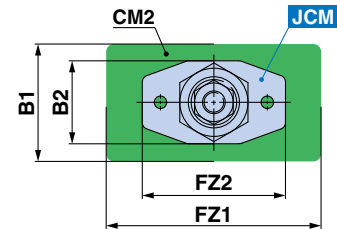

Width: Max. 33% reduction, Height: Max. 30% reduction

Dimension comparison (When mounted on the cylinder) [mm]

Bore size	Width				Height			
	CM2: FZ1	JCM: FZ2	Reduction	Reduction rate [%]	CM2: B1	JCM: B2	Reduction	Reduction rate [%]
ø20	75	50	25	33	34	26	8	24
ø25	75	58	17	23	40	28	12	30
ø32	75	63	12	16	40	36.5	3.5	9
ø40	82	70	12	15	52	44.5	7.5	14

Foot bracket

Weight: Max. 35% reduction

Weight comparison (When mounted on the cylinder, 50 mm stroke) [kg]

Bore size [mm]	CM2	JCM	Weight difference	Reduction rate [%]
ø20	0.33	0.23	0.1	29
ø25	0.43	0.31	0.12	28
ø32	0.52	0.39	0.13	25
ø40	0.96	0.62	0.34	35

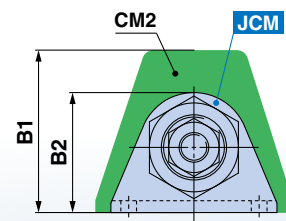
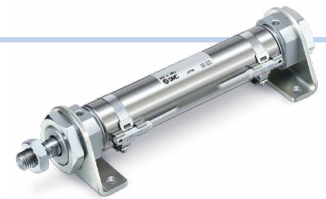

Height: 31% reduction

Dimension comparison (When mounted on the cylinder) [mm]

Bore size	Height			
	CM2: B1	JCM: B2	Reduction	Reduction rate [%]
ø20	40	29.5	10.5	26
ø25	47	32.5	14.5	31
ø32	47	40.5	6.5	14
ø40	54	48	6	11

New Part numbers for products with a rod end bracket are available.

It is not necessary to order a bracket for the applicable cylinder separately.

* Mounting brackets are shipped together with the product but do not come assembled.

Example) **JCDMBZ20-50-W-M9BW**

Rod end bracket	
Nil	No bracket
V	Single knuckle joint
W	Double knuckle joint

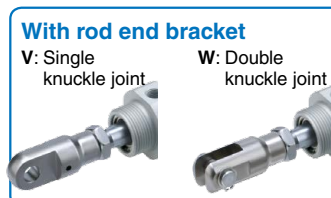

* Rod end brackets are the same as those for the CM2 series.

New mounting band for auto switch

Mounting height shortened

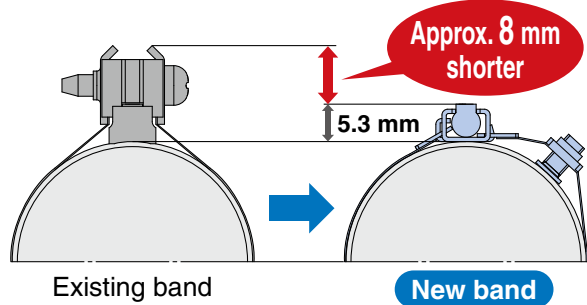

Improved visibility of indicator LED

There are no parts near the indicator LED, so visibility is improved.



Improved mounting workability

To mount the auto switch, simply insert it and position it correctly.

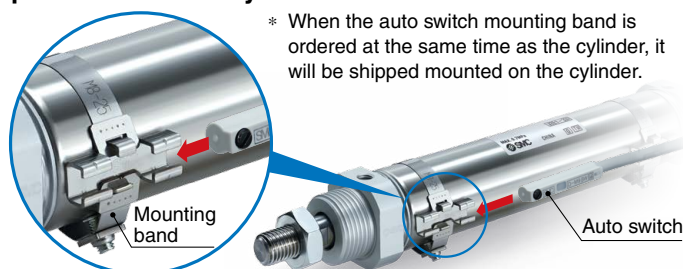

Related components

Floating Joint **JT Series**

A more compact and lightweight combination is possible by using the JCM series with a JT series floating joint.

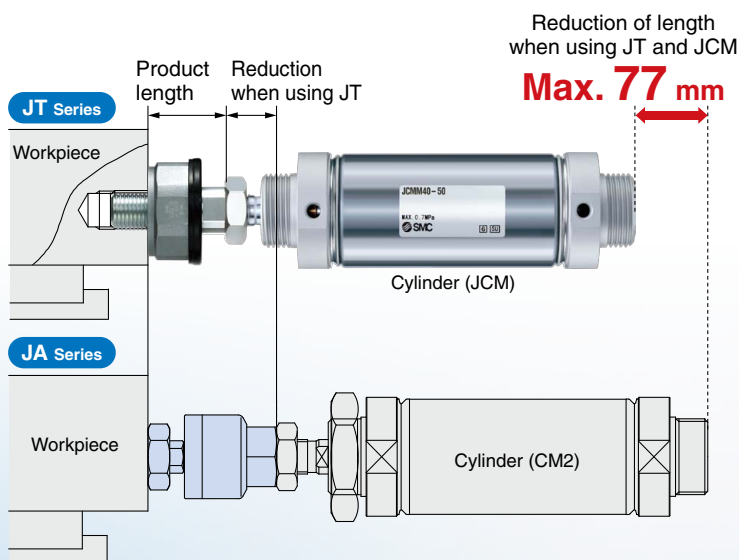

Overall Length Comparison

Size	JA + CM2 Series	JT + JCM Series	Reduction rate
20	139.5 mm	90.2 mm	35%
32	149.0 mm	96.0 mm	36%
40	189.0 mm	112.0 mm	41%

Weight Comparison

Size	JA + CM2 Series	JT + JCM Series	Reduction rate
20	190 g	102 g	46%
32	350 g	188 g	46%
40	720 g	378 g	48%

Refer to page 17 for details.

CONTENTS

How to Order p. 4
 Specifications p. 5
 Dimensions p. 7
 Dimensions of Accessories p. 12
 Auto Switch Mounting p. 13

Prior to Use: Auto Switch Connections and Examples ... p. 16
 Related Components p. 17
 Specific Product Precautions p. 18
 Safety Instructions Back cover

Air Cylinder

Double Acting, Single Rod

JCM Series

∅20, ∅25, ∅32, ∅40



How to Order

Without auto switch

JCM BZ 20 - 100

With auto switch

JCDM BZ 20 - 100 - M9BW

With auto switch
(Built-in magnet)

Mounting, Bracket

Mounting		Mounting, Bracket	
Direct mounting	With mounting bracket		
BZ Basic (Female thread on rod cover) 	L Axial foot 		
B Basic (Female thread on both covers) 	F Rod flange 		
M Male thread on both covers 	FZ Rod flange 		
MZ Male thread on rod cover 	G Head flange 		

Bore size

20	20 mm
25	25 mm
32	32 mm
40	40 mm

Port thread type

Nil	M5
TR	Rc1/8
TN	NPT1/8

Cylinder stroke [mm]
Refer to page 5 for standard strokes.

Rod end thread

Nil	Male thread
F	Female thread

Number of auto switches

Nil	2
S	1
n	n

Auto switch

Nil	Without auto switch
-----	---------------------

* For applicable auto switches, refer to the table below.

Rod end bracket

Nil	No bracket
V	Single knuckle joint
W	Double knuckle joint

* Select option "Nil" for the female rod end.
* A knuckle joint pin is not provided with the single knuckle joint.
* The rod end bracket is shipped together with the product.

Mounting nut*1

Nil	None
D	With mounting nut*2

*1 Only "Nil" can be selected for mounting options "B" and "BZ," and only "D" can be selected for mounting options "L," "F," "FZ," and "G." Either "Nil" or "D" can be selected for mounting options "M" and "MZ."

*2 Mounting option "L" is provided with 2 pcs. Other mounting options are only provided with 1 pc. The mounting nut is shipped together with the product but does not come assembled.

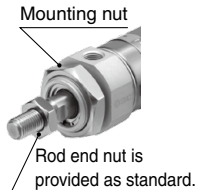

* Foot/flange brackets are shipped together with the product but do not come assembled.

Configuration contents of cylinders with a mounting bracket

Mounting	Bracket-mountable cylinder models	
	M: Male thread on both covers	MZ: Male thread on rod cover
L Axial foot	○ JCMM	×
F Rod flange	○ JCMM	×
FZ Rod flange	×	○ JCMMZ
G Head flange	○ JCMM	×

○...Bracket mountable ×...Not bracket mountable

Configuration contents (e.g.) mounting bracket single unit part number (Refer to page 5)

Example 1) JCML20-100D

- ① Cylinder : JCM20-100 (Male thread on both covers type)
- ② Foot bracket : JCM-L020 x 2 pcs.
- ③ Mounting nut : 2 pcs. (Included in the JCM-L020)

Example 2) JCMFZ20-100D

- ① Cylinder : JCM20-100 (Male thread on rod cover type)
- ② Rod flange : JCM-F020 x 1 pc.
- ③ Mounting nut : 1 pc. (Included in the JCM-F020)

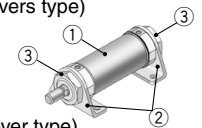

Applicable Auto Switches/Refer to the Web Catalog for further information on auto switches.

Type	Special function	Electrical entry	Indicator light	Wiring (Output)	Load voltage		Auto switch model		Lead wire length [m]				Pre-wired connector	Applicable load	
					DC	AC	Perpendicular	In-line	0.5 (Nil)	1 (M)	3 (L)	5 (Z)			
Solid state auto switch	—	Grommet	Yes	3-wire (NPN)	24 V	—	M9NV	M9N	●	●	●	○	○	IC circuit	
				3-wire (PNP)			M9PV	M9P	●	●	●	○	○		
				2-wire			M9BV	M9B	●	●	●	○	○		
				3-wire (NPN)			M9NWV	M9NW	●	●	●	○	○		
				3-wire (PNP)			M9PWV	M9PW	●	●	●	○	○		
				2-wire			M9B WV	M9B W	●	●	●	○	○		
	Diagnostic indication (2-color indicator)	Grommet	Yes	Yes	3-wire (NPN)	24 V	—	M9NAV*1	M9NA*1	○	○	●	○	○	IC circuit
					3-wire (PNP)			M9PAV*1	M9PA*1	○	○	●	○	○	
					2-wire			M9BAV*1	M9BA*1	○	○	●	○	○	
					2-wire					○	○	●	○	○	

*1 Water-resistant type auto switches can be mounted on the above models, but SMC cannot guarantee water resistance. Please contact SMC regarding water-resistant types with the above model numbers.

* Lead wire length symbols: 0.5 m..... Nil (Example) M9NW
1 m..... M (Example) M9NWM
3 m..... L (Example) M9NWL
5 m..... Z (Example) M9NWX

* Solid state auto switches marked with a "○" are produced upon receipt of order.

* Auto switches are shipped together with the product but do not come assembled. (Only the auto switch mounting brackets are assembled before shipment.)



Symbol

Double acting, Single rod

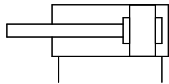

Refer to pages 13 to 15 for cylinders with auto switches.

- Auto Switch Proper Mounting Position (Detection at stroke end) and Mounting Height
- Minimum Stroke for Auto Switch Mounting
- Method of Mounting Two Auto Switches at the Stroke End of a Cylinder for Strokes Less Than 20 mm
- Precautions for Mounting Two D-M9 In-line Entry Type Auto Switches on the Same Surface
- Operating Range
- Auto Switch Mounting Brackets/Part Nos.

Specifications

Bore size [mm]	20	25	32	40	
Type	Pneumatic				
Action	Double acting, Single rod				
Fluid	Air				
Proof pressure	1.0 MPa				
Max. operating pressure	0.7 MPa* ²				
Min. operating pressure	0.05 MPa				
Ambient and fluid temperatures	5 to 60°C (No freezing)				
Lubrication	Not required (Non-lube)				
Stroke length tolerance	$+2.0$ mm				
Piston speed* ¹	50 to 500 mm/s* ²				
Cushion	Rubber bumper				
Allowable kinetic energy [J]	Male thread	0.11	0.18	0.29	0.52
	Female thread	0.11	0.18	0.18	0.52

* Operate the cylinder within the allowable kinetic energy.

*¹ Depending on the system configuration selected, the specified speed may not be satisfied.

*² Max. operating pressure and piston speed are different from those of the existing model (CM2 series).

Standard Strokes

Bore size [mm]	Standard stroke [mm] * ¹
20	25, 50, 75, 100, 125, 150, 200, 250, 300
25	
32	
40	

*¹ Intermediate strokes not listed above are produced upon receipt of order. The minimum stroke is 25 mm.

Mounting Brackets/Part Nos.

Mounting bracket	Minimum order quantity	Bore size [mm]				Contents
		20	25	32	40	
Mounting nut (M18, M22, M27)	1	JSN-020B	JSN-032B		JSN-040B	1 mounting nut
Rod end nut	1	NT-02	NT-03		NT-04	1 rod end nut
Foot bracket* ¹	2	JCM-L020	JCM-L025	JCM-L032	JCM-L040	1 foot bracket, 1 mounting nut
Flange bracket* ²	1	JCM-F020	JCM-F025	JCM-F032	JCM-F040	1 flange bracket, 1 mounting nut
Single knuckle joint	1	I-020B	I-032B		I-040B	1 single knuckle joint
Double knuckle joint	1	Y-020B	Y-032B		Y-040B	1 double knuckle joint, 1 clevis pin, 2 retaining rings

*¹ The foot bracket can only be used with option "M."

Order 2 foot brackets for each cylinder unit.

*² The rod flange can only be used with options "M" and "MZ."

The head flange can only be used with option "M."

* Refer to page 12 for dimensions.

Mounting Brackets/Material, Surface Treatment

Segment	Description	Material	Surface treatment
Mounting brackets	Mounting nut	Carbon steel	Zinc chromating
	Rod end nut	Carbon steel	Zinc chromating
Mounting brackets	Foot bracket	Carbon steel	Zinc chromating
	Flange bracket	Carbon steel	Zinc chromating
Accessories	Single knuckle joint	Carbon steel ø40: Free-cutting steel	Electroless nickel plating
	Double knuckle joint	Carbon steel ø40: Cast iron	Electroless nickel plating Metallic silver color painting for ø40
	Double knuckle joint pin	Carbon steel	(None)

Weight

Male Rod End, Without Magnet

[kg]

Bore size [mm]		20	25	32	40
Basic weight	JCMBZ□-□ (Basic (Female thread on rod cover), M5 port)	0.07	0.11	0.14	0.27
	JCMBZ□□-□ (Basic (Female thread on rod cover), Rc1/8, NPT1/8 port)	0.09	0.12	0.16	0.29
	JCMB□-□ (Basic (Female thread on both covers), M5 port)	0.07	0.11	0.14	0.27
	JCMB□□-□ (Basic (Female thread on both covers), Rc1/8, NPT1/8 port)	0.09	0.12	0.16	0.29
	JCMM□-□ (Male thread on both covers, M5 port)	0.08	0.12	0.15	0.28
	JCMM□□-□ (Male thread on both covers, Rc1/8, NPT1/8 port)	0.10	0.14	0.18	0.32
	JCMMZ□-□ (Male thread on rod cover, M5 port)	0.07	0.11	0.14	0.26
	JCMMZ□□-□ (Male thread on rod cover, Rc1/8, NPT1/8 port)	0.09	0.13	0.17	0.30
Additional weight per 50 mm of stroke		0.04	0.05	0.06	0.10
Additional weight for mounting bracket	Mounting nut (JCMM, JCMMZ only)	0.014	0.022	0.022	0.034
Additional weight for mounting bracket	Foot bracket (JCMM only)	0.03	0.04	0.05	0.06
	Flange bracket (JCMM, JCMMZ only)	0.02	0.03	0.04	0.05
Option Additional bracket weight	Single knuckle joint	0.06	0.06	0.06	0.23
	Double knuckle joint (with pin)	0.07	0.07	0.07	0.20
Additional weight with magnet		0.01	0.02	0.02	0.03

Calculation: (Example) **JCDML32-100D**

- Basic weight.....0.15 (JCMM32-□)
 - Additional weight.....0.06/50 mm stroke
 - Stroke.....100 mm stroke
 - Foot bracket (2 pcs.).....0.05 x 2
 - Mounting nut (2 pcs.)0.022 x 2
 - Additional weight with magnet ..0.02
- $0.15 + (0.06 \times 100/50) + (0.05 \times 2) + (0.022 \times 2) + 0.02 = \mathbf{0.434 \text{ kg}}$

Female Rod End, Without Magnet

[kg]

Bore size [mm]		20	25	32	40
Basic weight	JCMBZ□-□F (Basic (Female thread on rod cover), M5 port)	0.06	0.09	0.12	0.22
	JCMBZ□□-□F (Basic (Female thread on rod cover), Rc1/8, NPT1/8 port)	0.08	0.10	0.14	0.24
	JCMB□-□F (Basic (Female thread on both covers), M5 port)	0.06	0.09	0.12	0.22
	JCMB□□-□F (Basic (Female thread on both covers), Rc1/8, NPT1/8 port)	0.08	0.10	0.14	0.24
	JCMM□-□F (Male thread on both covers, M5 port)	0.07	0.10	0.13	0.24
	JCMM□□-□F (Male thread on both covers, Rc1/8, NPT1/8 port)	0.09	0.12	0.16	0.27
	JCMMZ□-□F (Male thread on rod cover, M5 port)	0.06	0.09	0.12	0.22
	JCMMZ□□-□F (Male thread on rod cover, Rc1/8, NPT1/8 port)	0.08	0.11	0.15	0.26
Additional weight per 50 mm of stroke		0.04	0.05	0.06	0.10
Additional weight for mounting bracket	Mounting nut (JCMM, JCMMZ only)	0.014	0.022	0.022	0.034
Additional weight for mounting bracket	Foot bracket (JCMM only)	0.03	0.04	0.05	0.06
	Flange bracket (JCMM, JCMMZ only)	0.02	0.03	0.04	0.05
Option Additional bracket weight	Single knuckle joint	0.06	0.06	0.06	0.23
	Double knuckle joint (with pin)	0.07	0.07	0.07	0.20
Additional weight with magnet		0.01	0.02	0.02	0.03

Calculation: (Example) **JCMFZ32TR-100FD**

- Basic weight.....0.15 (JCMMZ32TR-□F)
 - Additional weight.....0.06/50 mm stroke
 - Stroke.....100 mm stroke
 - Flange bracket0.04
 - Mounting nut0.022
- $0.15 + (0.06 \times 100/50) + 0.04 + 0.022 = \mathbf{0.352 \text{ kg}}$

Allowable Kinetic Energy

Table (1) Max. Allowable Kinetic Energy

[J]

Bore size [mm]	20	25	32	40
Male rod end	0.11	0.18	0.29	0.52
Female rod end	0.11	0.18	0.18	0.52

Kinetic energy $E [J] = \frac{(m_1 + m_2) V^2}{2}$

m_1 : Mass of cylinder moving parts kg
 m_2 : Load mass kg
 V : Piston speed at the end m/s

Table (2) Mass of Cylinder Moving Parts Without Built-in Magnet/0 Stroke

[kg]

Bore size [mm]		20	25	32	40
BZ	Basic (Female thread on rod cover)	0.02	0.03	0.04	0.07
B	Basic (Female thread on both covers)				
M	Male thread on both covers	0.03	0.04	0.05	0.1
MZ	Male thread on rod cover				

Table (3) Additional Weight

[kg]

Bore size [mm]	20	25	32	40
Additional weight per 50 mm of stroke	0.02	0.03	0.03	0.06

* Do not apply a lateral load over the allowable range to the rod end when it is mounted horizontally.

Allowable Lateral Load at Rod End

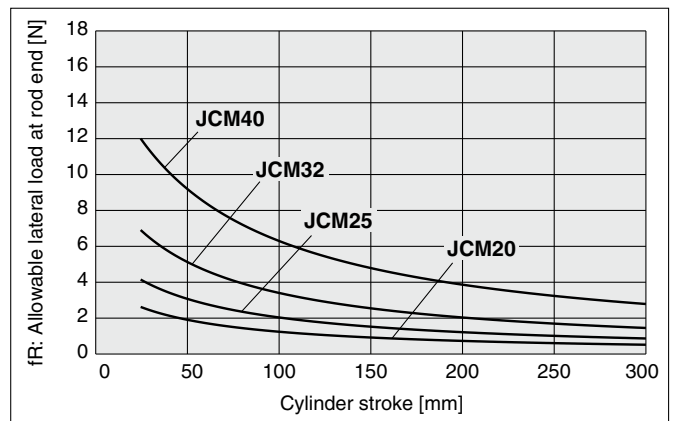
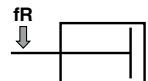

Basic (Female Thread on Rod Cover) (BZ)

JC MBZ —

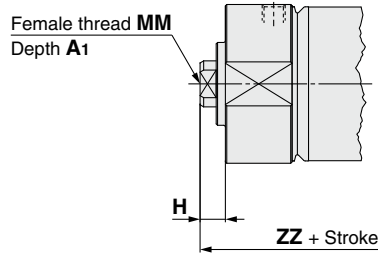
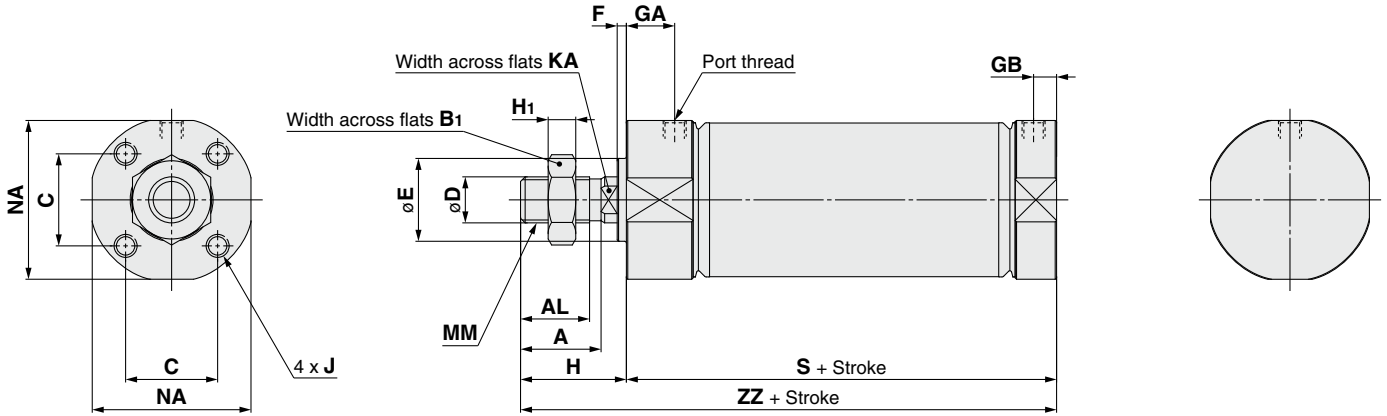

Female rod end

													[mm] Female Rod End [mm]				
Bore size	A	AL	B1	C	D	E	F	H	H1	J	KA	MM	NA	Bore size	A1	H	MM
20	14.5	12	13	15.5	8	14 ⁰ _{-0.1}	2	21	5	M4 x 0.7 depth 7	Width across flats 6 length 3.5	M8 x 1.25	24	20	8	6.5	M4 x 0.7
25	17.5	15	17	16.5	10	14 ⁰ _{-0.1}	2	24	6	M5 x 0.8 depth 7.5	Width across flats 8 length 3.5	M10 x 1.25	27	25	8	6.5	M5 x 0.8
32	17.5	15	17	20	10	18 ⁰ _{-0.1}	2	24	6	M5 x 0.8 depth 8	Width across flats 8 length 3.5	M10 x 1.25	34.5	32	12	6.5	M5 x 0.8
40	23.5	20.5	22	24	14	24 ⁰ _{-0.1}	2	30	8	M6 x 1 depth 10	Width across flats 12 length 3.5	M14 x 1.5	42.5	40	13	6.5	M8 x 1.25

Port Thread: M5 [mm]					Female Rod End [mm]	
Bore size	GA	GB	S	ZZ	Bore size	ZZ
20	9	5	41 (46.5)	62 (67.5)	20	47.5 (53)
25	11	5	43.5 (49)	67.5 (73)	25	50 (55.5)
32	10.5	5	43.5 (49.5)	67.5 (73.5)	32	50 (56)
40	11	5	50.5 (56.5)	80.5 (86.5)	40	57 (63)

Port Thread: Rc1/8, NPT1/8 [mm]						Female Rod End [mm]	
Bore size	GA		GB	S	ZZ	Bore size	ZZ
	Rc1/8	NPT1/8					
20	10.5	11	7.5	54 (59.5)	75 (80.5)	20	60.5 (66)
25	10.5	11	7.5	52.5 (58)	76.5 (82)	25	59 (64.5)
32	10.5	10.5	7.5	53 (59)	77 (83)	32	59.5 (65.5)
40	10.5	10.5	7.5	57.5 (63.5)	87.5 (93.5)	40	64 (70)

* (): Dimensions of built-in magnet type



Basic (Female Thread on Both Covers) (B)

JC MB —

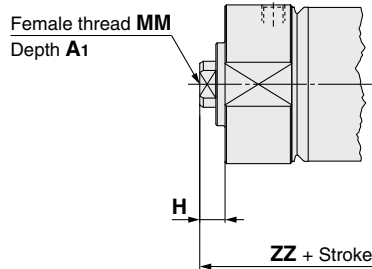
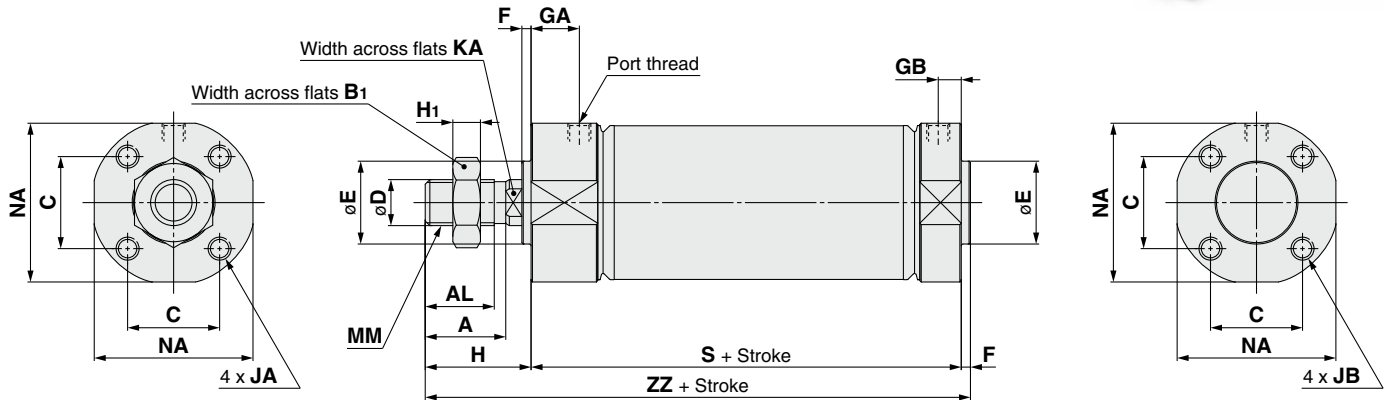

Female rod end

															[mm] Female Rod End [mm]			
Bore size	A	AL	B ₁	C	D	E	F	H	H ₁	JA	JB	KA	MM	NA	Bore size	A ₁	H	MM
20	14.5	12	13	15.5	8	14 ⁰ _{0.1}	2	21	5	M4 x 0.7 depth 7	M4 x 0.7 depth 5.5	Width across flats 6 length 3.5	M8 x 1.25	24	20	8	6.5	M4 x 0.7
25	17.5	15	17	16.5	10	14 ⁰ _{0.1}	2	24	6	M5 x 0.8 depth 7.5	M5 x 0.8 depth 6	Width across flats 8 length 3.5	M10 x 1.25	27	25	8	6.5	M5 x 0.8
32	17.5	15	17	20	10	18 ⁰ _{0.1}	2	24	6	M5 x 0.8 depth 8	M5 x 0.8 depth 6	Width across flats 8 length 3.5	M10 x 1.25	34.5	32	12	6.5	M5 x 0.8
40	23.5	20.5	22	24	14	24 ⁰ _{0.1}	2	30	8	M6 x 1 depth 10	M6 x 1 depth 7	Width across flats 12 length 3.5	M14 x 1.5	42.5	40	13	6.5	M8 x 1.25

Port Thread: M5 [mm]					Female Rod End [mm]	
Bore size	GA	GB	S	ZZ	Bore size	ZZ
20	9	5	41 (46.5)	64 (69.5)	20	49.5 (55)
25	11	5	43.5 (49)	69.5 (75)	25	52 (57.5)
32	10.5	5	43.5 (49.5)	69.5 (75.5)	32	52 (58)
40	11	5	50.5 (56.5)	82.5 (88.5)	40	59 (65)

Port Thread: Rc1/8, NPT1/8 [mm]						Female Rod End [mm]	
Bore size	GA		GB	S	ZZ	Bore size	ZZ
	Rc1/8	NPT1/8					
20	10.5	11	7.5	54 (59.5)	77 (82.5)	20	62.5 (68)
25	10.5	11	7.5	52.5 (58)	78.5 (84)	25	61 (66.5)
32	10.5	10.5	7.5	53 (59)	79 (85)	32	61.5 (67.5)
40	10.5	10.5	7.5	57.5 (63.5)	89.5 (95.5)	40	66 (72)

* (): Dimensions of built-in magnet type

JCM Series

Male Thread on Both Covers (M)

JC MM —

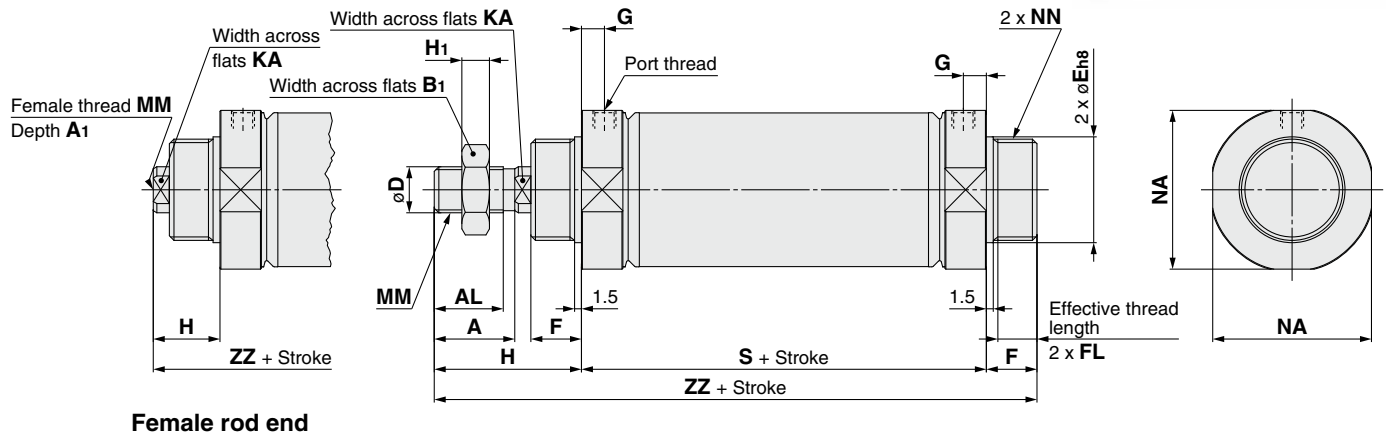

Female rod end

Bore size	A	AL	B ₁	D	E	F	FL	H	H ₁	KA	MM	NA	NN	Female Rod End [mm]			
														Bore size	A ₁	H	MM
20	14.5	12	13	8	18 ⁰ _{-0.033}	11	8.5	30	5	Width across flats 6 length 3.5	M8 x 1.25	24	M18 x 1.5	20	8	15.5	M4 x 0.7
25	17.5	15	17	10	22 ⁰ _{-0.033}	11	8.5	33	6	Width across flats 8 length 3.5	M10 x 1.25	27	M22 x 1.5	25	8	15.5	M5 x 0.8
32	17.5	15	17	10	22 ⁰ _{-0.033}	11	8.5	33	6	Width across flats 8 length 3.5	M10 x 1.25	34.5	M22 x 1.5	32	12	15.5	M5 x 0.8
40	23.5	20.5	22	14	27 ⁰ _{-0.039}	12	9.5	39	8	Width across flats 12 length 3.5	M14 x 1.5	42.5	M27 x 2	40	13	15.5	M8 x 1.25

Port Thread: M5 [mm]				Female Rod End [mm]		Port Thread: Rc1/8, NPT1/8 [mm]				Female Rod End [mm]	
Bore size	G	S	ZZ	Bore size	ZZ	Bore size	G	S	ZZ	Bore size	ZZ
20	5	37 (42.5)	78 (83.5)	20	63.5 (69)	20	7.5	49 (54.5)	90 (95.5)	20	75.5 (81)
25	5	37.5 (43)	81.5 (87)	25	64 (69.5)	25	7.5	49.5 (55)	93.5 (99)	25	76 (81.5)
32	5	38 (44)	82 (88)	32	64.5 (70.5)	32	7.5	50 (56)	94 (100)	32	76.5 (82.5)
40	5	44.5 (50.5)	95.5 (101.5)	40	72 (78)	40	7.5	54.5 (60.5)	105.5 (111.5)	40	82 (88)

* (): Dimensions of built-in magnet type

JCM Series

Flange

Rod flange: JCMF, JCMFZ

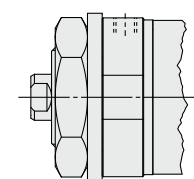

Female rod end

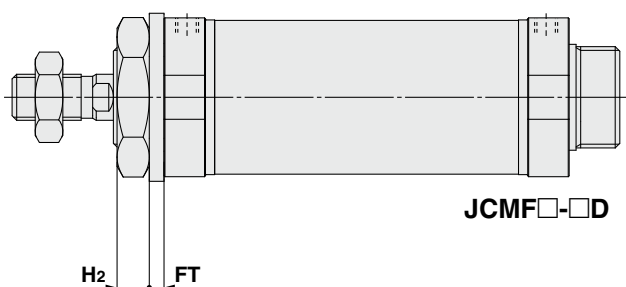

JCMF□-□D

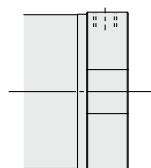
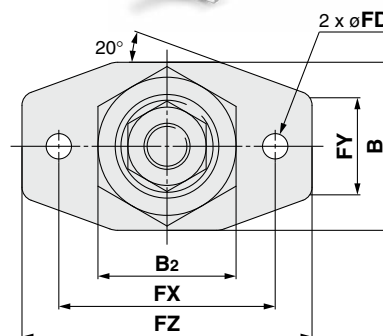

JCMFZ□-□D

Head flange: JCMG

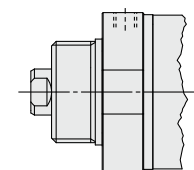

Female rod end

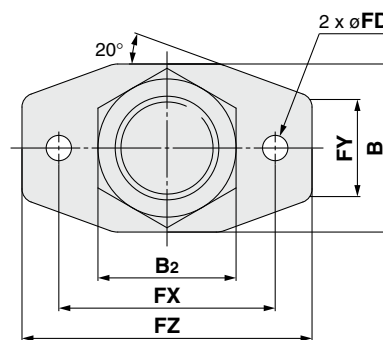
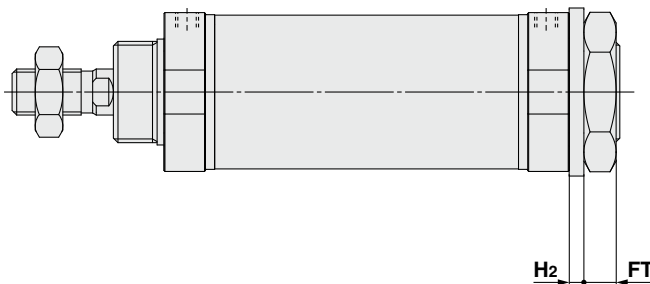

[mm]

Bore size	B	B ₂	FD	FT	FX	FY	FZ	H ₂
20	26	24	4.5	3.2	38	16.5	50	7
25	28	30	4.5	3.2	46	18.5	58	7
32	36.5	30	5.5	3.2	47	22	63	7
40	44.5	36	5.5	3.2	56	28	70	8

JCM Series

Dimensions of Accessories

Single Knuckle Joint

[mm]

I-020B, 032B

Material: Carbon steel

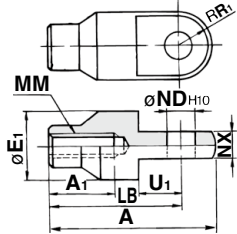

I-040B

Material: Free cutting carbon steel

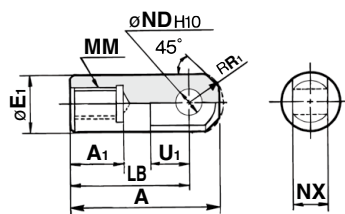

Part no.	Applicable bore size	A	A ₁	E ₁	LB	MM	ND _{H10}	NX	R ₁	U ₁
I-020B	20	46	16	20	36	M8 x 1.25	9 ^{+0.058} ₀	9 ^{-0.1} _{-0.2}	10	14
I-032B	25, 32	48	18	20	38	M10 x 1.25	9 ^{+0.058} ₀	9 ^{-0.1} _{-0.2}	10	14
I-040B	40	69	22	24	55	M14 x 1.5	12 ^{+0.070} ₀	16 ^{-0.1} _{-0.3}	15.5	20

Double Knuckle Joint

[mm]

Y-020B, Y-032B

Material: Carbon steel

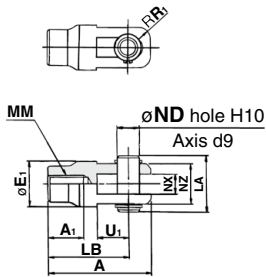

Y-040B

Material: Cast iron

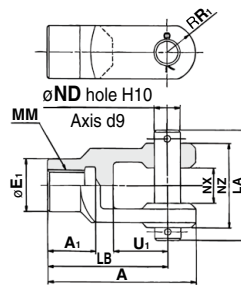

Part no.	Applicable bore size	A	A ₁	E ₁	LA	LB	MM	ND	NX	NZ	R ₁	U ₁	Included pin part number	Retaining ring size Split pin
Y-020B	20	46	16	20	25	36	M8 x 1.25	9	9 ^{+0.2} _{+0.1}	18	5	14	CDP-1	Type C 9 for axis
Y-032B	25, 32	48	18	20	25	38	M10 x 1.25	9	9 ^{+0.2} _{+0.1}	18	5	14	CDP-1	Type C 9 for axis
Y-040B	40	68	22	24	49.7	55	M14 x 1.5	12	16 ^{+0.3} _{+0.1}	38	13	25	CDP-3	ø3 x 18L

* A knuckle pin and retaining rings (split pins for ø40) are included.

Double Clevis Pin

Material: Carbon steel [mm]

Bore size: ø20, ø25, ø32

CDP-1

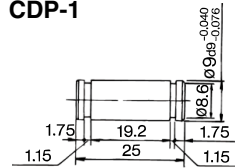

Retaining ring: Type C9 for axis

* Retaining rings (split pins for ø40) are included.

Bore size: ø40

CDP-3

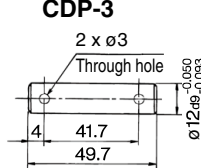

Split pin ø3 x 18L

Rod End Nut (Standard)

Material: Carbon steel [mm]

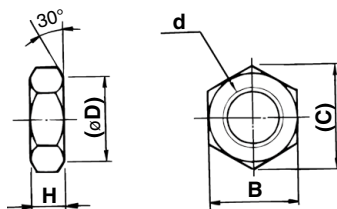

Part no.	Applicable bore size	B	(C)	(D)	d	H
NT-02	20	13	(15.0)	12.5	M8 x 1.25	5
NT-03	25, 32	17	(19.6)	16.5	M10 x 1.25	6
NT-04	40	22	(25.4)	21.0	M14 x 1.5	8

Mounting Nut

Material: Carbon steel [mm]

* For M and MZ only

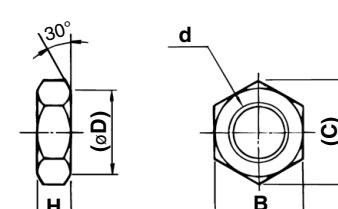

Part no.	Applicable bore size	B	(C)	(D)	d	H
JSN-020B	20	24	(27.7)	24	M18 x 1.5	7
JSN-032B	25, 32	30	(34.6)	30	M22 x 1.5	7
JSN-040B	40	36	(41.6)	36	M27 x 2.0	8

JCM Series Auto Switch Mounting

Auto Switch Proper Mounting Position (Detection at stroke end) and Mounting Height

Solid state auto switch

D-M9□
D-M9□W
D-M9□A

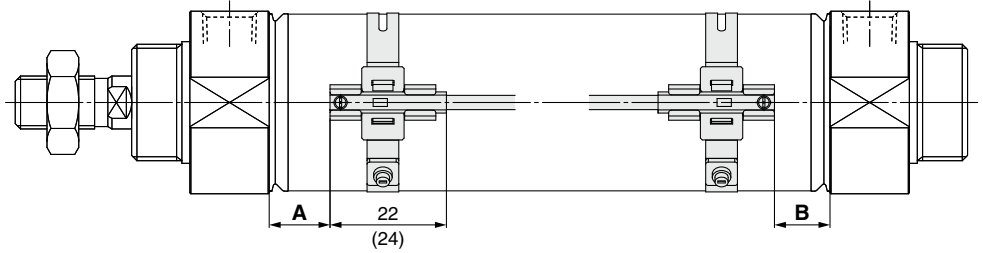
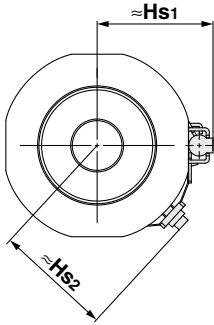

() : Dimension of the D-M9□A
A and B are the dimensions from the end of the head cover/rod cover to the end of the auto switch.

D-M9□V
D-M9□WV
D-M9□AV

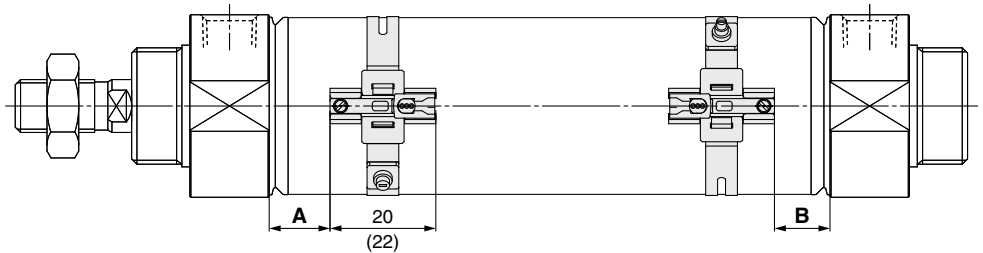
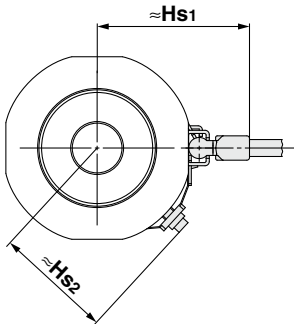

() : Dimension of the D-M9□AV
A and B are the dimensions from the end of the head cover/rod cover to the end of the auto switch.

When the cylinder is shipped from the factory, the set screw of the auto switch mounting band is sometimes mounted facing 180° in the opposite direction of the figure above.

Auto Switch Proper Mounting Position

[mm]

Auto switch model	D-M9□(V) D-M9□W(V) D-M9□A(V)	
	A	B
20	4	8.5
25	4.5	9
32	4.5	9.5
40	7	12

* Adjust the auto switch after confirming the operating condition in the actual setting.

Auto Switch Mounting Height

[mm]

Auto switch model	D-M9□ D-M9□W		D-M9□A	D-M9□V D-M9□WV D-M9□AV	
	Hs1	Hs2	Hs1, Hs2	Hs1	Hs2
20	16.5	17	17	23	17
25	19	19.5	19.5	25.5	19.5
32	22.5	23	23	29	23
40	26.5	27	27	32.5	27

Minimum Stroke for Auto Switch Mounting

n: Number of auto switches [mm]

Auto switch model	Number of auto switches				
	1	2		n	
		Different surfaces	Same surface	Different surfaces	Same surface
D-M9□	25	25	40	$20 + 35 \frac{(n-2)}{2}$ (n = 2, 4, 6...)*1	$55 + 35 (n-2)$ (n = 2, 3, 4, 5...)
D-M9□W	25	25	40	$20 + 35 \frac{(n-2)}{2}$ (n = 2, 4, 6...)*1	$55 + 35 (n-2)$ (n = 2, 3, 4, 5...)
D-M9□A	25	25	40	$25 + 35 \frac{(n-2)}{2}$ (n = 2, 4, 6...)*1	$60 + 35 (n-2)$ (n = 2, 3, 4, 5...)
D-M9□V	25	25	35	$20 + 35 \frac{(n-2)}{2}$ (n = 2, 4, 6...)*1	$35 + 35 (n-2)$ (n = 2, 3, 4, 5...)
D-M9□WV D-M9□AV	25	25	35	$20 + 35 \frac{(n-2)}{2}$ (n = 2, 4, 6...)*1	$35 + 35 (n-2)$ (n = 2, 3, 4, 5...)

*1 When "n" is an odd number, an even number that is one larger than the odd number is to be used for the calculation.

Method of Mounting Two Auto Switches at the Stroke End of a Cylinder for Strokes Less Than 20 mm

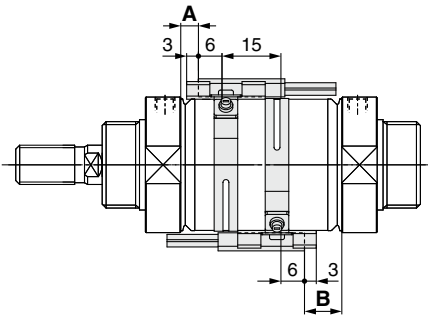
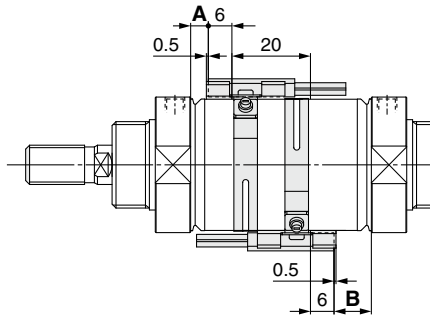
Auto switch model	Applicable strokes	
	15 mm stroke	20 mm stroke
D-M9□(V) D-M9□W(V) D-M9□A(V)	 <p>· The correct mounting position of the D-M9 is 3 mm from the end face of the switch holder (dimensions A and B).</p>	 <p>· The correct mounting position of the D-M9 is 0.5 mm from the end face of the switch holder (dimensions A and B).</p>

Precautions for Mounting Two D-M9 In-line Entry Type Auto Switches on the Same Surface

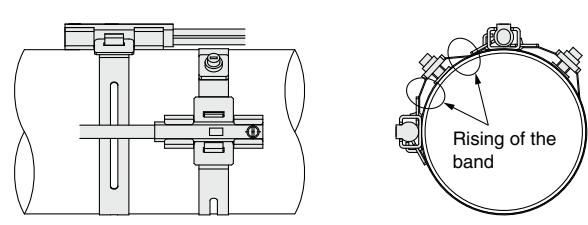
Auto switch model	Applicable strokes	When mounting two auto switches on the same surface at the stroke indicated to the left
D-M9□ D-M9□W	40 to 54	 <p>· The location where the M3 set screw for securing the auto switch mounting band is mounted (nut part) is raised, so it is necessary to adjust the mounting position in the circumferential direction of the cylinder tube to prevent interference with the D-M9 and the lead wires.</p>
D-M9□A	40 to 59	

Operating Range

[mm]

Auto switch model	Bore size			
	20	25	32	40
D-M9□(V) D-M9□W(V) D-M9□A(V)	2.5	2.5	3	3

* Values which include hysteresis are for guideline purposes only, they are not a guarantee (assuming approximately ±30% dispersion) and may change substantially depending on the ambient environment.

* When an auto switch is used, mount it at the center of the operating range.

Auto Switch Mounting Brackets/Part Nos.

Auto switch model	Bore size [mm]			
	ø20	ø25	ø32	ø40
D-M9□(V) D-M9□W(V)	BM8-020 (A set of a, b, c)	BM8-025 (A set of a, b, c)	BM8-032 (A set of a, b, c)	BM8-040 (A set of a, b, c)
D-M9□A(V)	BM8-020S (A set of a, b, c) * S: Stainless steel set screw	BM8-025S (A set of a, b, c) * S: Stainless steel set screw	BM8-032S (A set of a, b, c) * S: Stainless steel set screw	BM8-040S (A set of a, b, c) * S: Stainless steel set screw

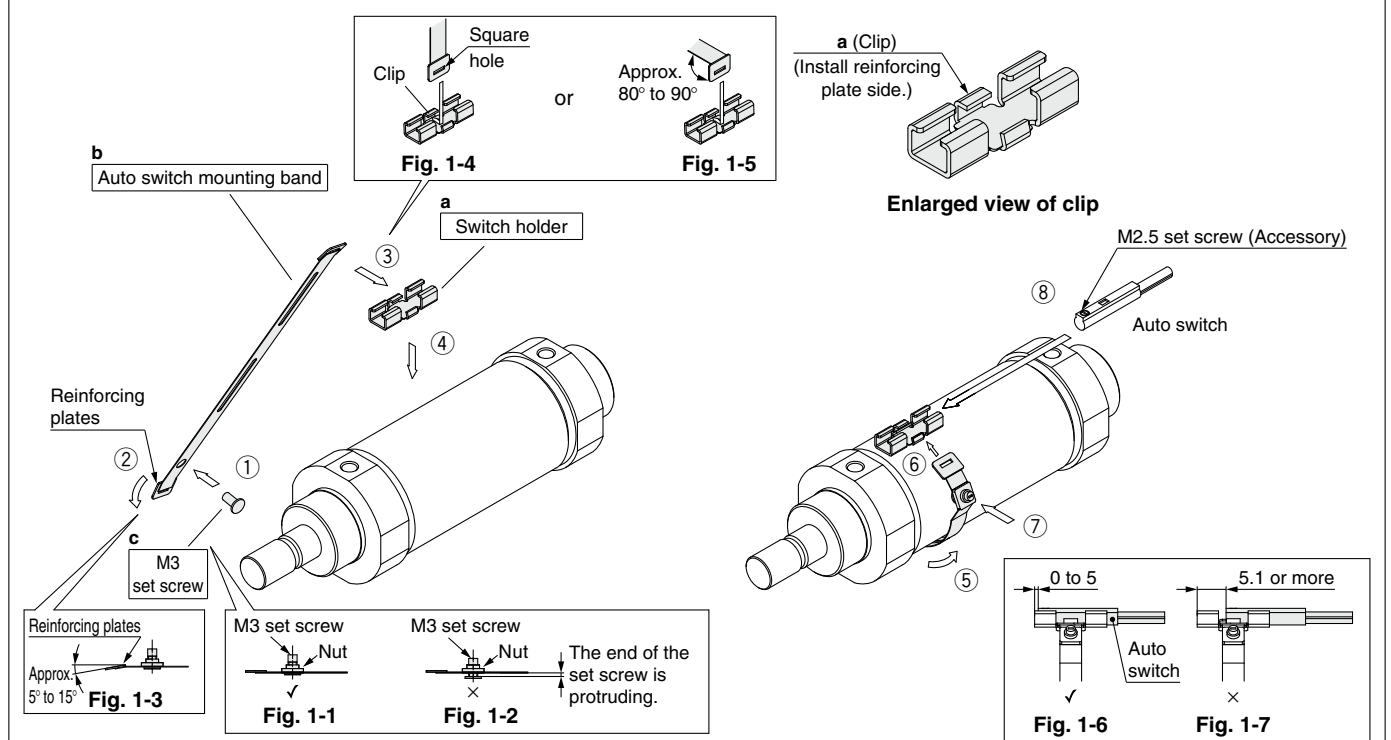

<Mounting the Auto Switch>

* When the cylinder is ordered fitted with an auto switch, it is shipped with the auto switch mounting band installed. In this case, only step ⑧ is necessary. The installation position of the auto switch mounting band serves only as a rough guide, so check the operating condition of the auto switch and then readjust the band.

- ① As shown in Fig. 1-1, turn the set screw (c) into the nut (M3) of the auto switch mounting band (b. Hereafter called "band") in the clockwise direction from the bottom side of the nut.
 - * When mounting the set screw, take care that it does not protrude. (Fig. 1-2)
- ② Bend the reinforcing plate on the nut (M3) side, as shown in Fig. 1-3.
- ③ Pass the clip of the switch holder (a) through the square hole in the side of the reinforcing plate that was not bent in step ②. (Fig. 1-4 and Fig. 1-5)
- ④ Place the switch holder on the cylinder tube in the state of step ③.
- ⑤ Wrap the band around the cylinder tube.
 - It is necessary to press down on the switch holder with your fingers to ensure that it does not move out of position.
- ⑥ Push the other clip of the switch holder into the square hole in the band, and fit these parts together.
 - This can be facilitated by bringing the clip near the square hole in the band.
- ⑦ Set the switch holder of step ⑥ in the approximate mounting position on the cylinder tube, then turn the set screw of step ① in the clockwise direction and secure the band in place.
 - Use a watchmaker's (precision) screwdriver that has a bit diameter of between 1.4 and 1.8 mm.
 - The tightening torque of the M3 set screw is between 0.1 and 0.15 N·m. A tightening condition that is equivalent to this torque is obtained by tightening the set screw until 1.5 to 2 thread ridges remain visible on the head side of the set screw.

* A watchmaker's (precision) screwdriver has a small gripping diameter, so the tightening of the M3 set screw of the band may sometimes be insufficient. To prevent this, check the number of thread ridges that remain visible on the head side of the set screw in step ⑦, and confirm that the band is securely fastened.

- ⑧ Install the auto switch on the switch holder, and secure it in place.

- Install the auto switch in the state of Fig. 1-6.
- The tightening torque for the M2.5 set screw for fixing the auto switch is between 0.02 and 0.05 N·m. As a rough guide, use a precision screwdriver that has a gripping diameter of 5 to 6 mm, and turn 90° from the position in which it comes to feel tight.

<Removing the Auto Switch>

- Turn the M2.5 set screw provided with the auto switch in the counterclockwise direction, and remove the auto switch.

<When Removing the Auto Switch Mounting Band>

- First, remove the auto switch from the switch holder.
- Turn the M3 set screw that was used for securing the band, in the counterclockwise direction, so that the state of Fig. 1-1 is obtained.
 - Press the switch holder against the cylinder tube, then while pushing up the set screw in the state of Fig. 1-1 and the reinforcing plate on the nut side, along the clip (oblique profile side), raise the part of the reinforcing plate that has the square hole, and remove the clip from the square hole.

* Because the auto switch mounting part on the switch holder has only a small clearance, the auto switch may sometimes fail to move when the M2.5 set screw provided is loosened. In such a case, press down on the top part of the auto switch using your fingers.

⚠ Caution

When the band set screw on the cylinder tube and also the mounting face of the D-M9 are located at the bottom of the cylinder mounting face, as shown in the figure to the right, it is conceivable that this may interfere with maintenance. For this reason, when installing the cylinder, be careful of the mounting of the D-M9.

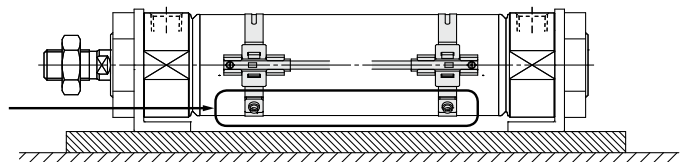

Prior to Use

Auto Switch Connections and Examples

Sink Input Specifications

3-wire, NPN

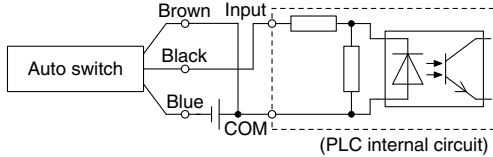

2-wire

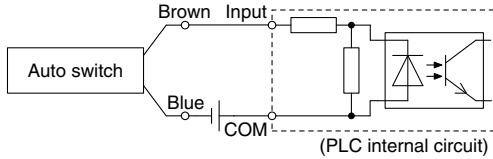

Source Input Specifications

3-wire, PNP

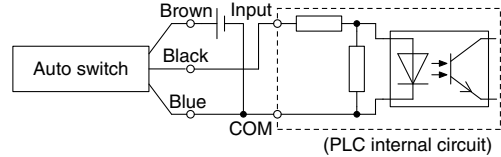

2-wire

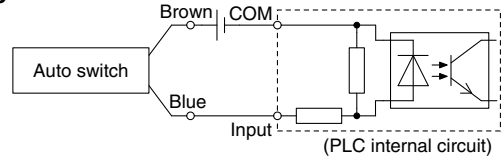

Connect according to the applicable PLC input specifications, as the connection method will vary depending on the PLC input specifications.

Examples of AND (Series) and OR (Parallel) Connections

* When using solid state auto switches, ensure the application is set up so the signals for the first 50 ms are invalid. Depending on the operating environment, the product may not operate properly.

3-wire AND connection for NPN output (Using relays)

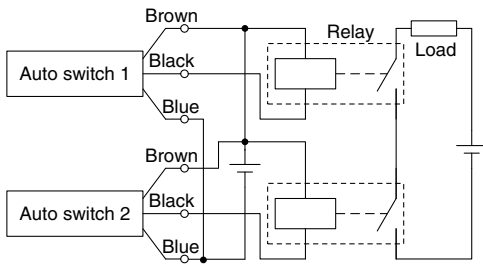

(Performed with auto switches only)

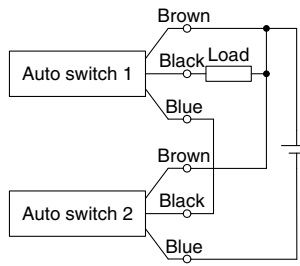

3-wire OR connection for NPN output

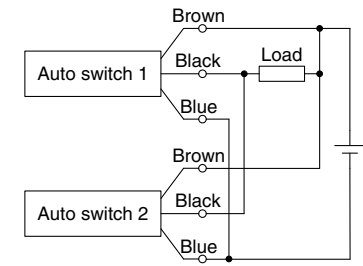

3-wire AND connection for PNP output (Using relays)

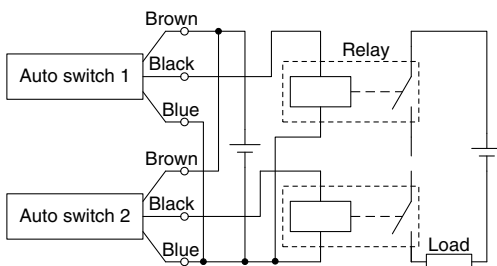

(Performed with auto switches only)

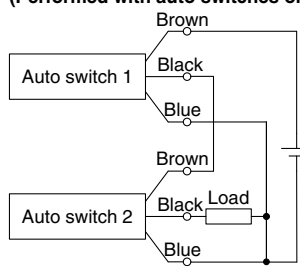

3-wire OR connection for PNP output

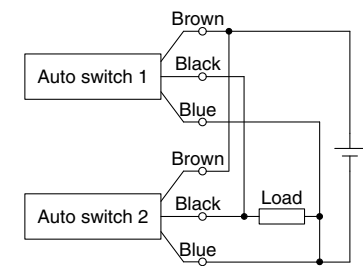

2-wire AND connection

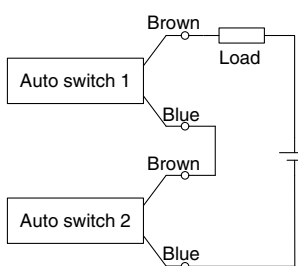

When two auto switches are connected in series, a load may malfunction because the load voltage will decline when in the ON state. The indicator lights will light up when both of the auto switches are in the ON state. Auto switches with a load voltage less than 20 V cannot be used. Please contact SMC if using AND connection for a heat-resistant solid state auto switch or a trimmer switch.

Example) Load voltage at ON
 Power supply voltage: 24 VDC
 Internal voltage drop: 4 V
 Load voltage at ON = Power supply voltage –
 Internal voltage drop x 2 pcs.
 = 24 V – 4 V x 2 pcs.
 = 16 V

2-wire OR connection

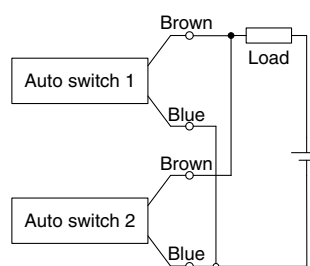

(Solid state)
 When two auto switches are connected in parallel, malfunction may occur because the load voltage will increase when in the OFF state.

(Reed)
 Because there is no current leakage, the load voltage will not increase when turned OFF. However, depending on the number of auto switches in the ON state, the indicator lights may sometimes grow dim or not light up, due to the dispersion and reduction of the current flowing to the auto switches.

Example) Load voltage at OFF
 Leakage current: 1 mA
 Load impedance: 3 kΩ
 Load voltage at OFF = Leakage current x 2 pcs. x
 Load impedance
 = 1 mA x 2 pcs. x 3 kΩ
 = 6 V

JCM Series Related Components



Standard/Lightweight and Compact Type Floating Joint JT Series

A more compact and lightweight combination is possible by using the JCM series with a JT series floating joint, standard/lightweight and compact type. (Refer to page 3 for details.)

Specifications

Model	Nominal thread size	Allowable axial force [N]	Allowable eccentricity U [mm]	Rotating angle [°]	Operating temperature range
JT20	M8 x 1.25	220	0.5	±2	-10 to 70°C
JT32	M10 x 1.25	560	0.5	±2	
JT40	M14 x 1.5	880	0.75	±2	

Operating range

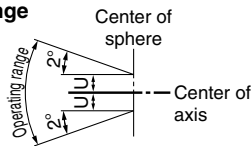

Applicable Cylinder

Model	Applicable cylinder*1		Recommended cylinder
	Bore size	Operating pressure	
JT20	ø20	0.7 MPa or less	JC□M20 (Rod end male thread type)
JT32	ø25		JC□M25 (Rod end male thread type)
	ø32		JC□M32 (Rod end male thread type)
JT40	ø40		JC□M40 (Rod end male thread type)

*1 Make sure to use a cylinder with a built-in cushion mechanism.

How to Order

JT **20**

Size	Applicable cylinder	Nominal thread size
20	For ø20	M8 x 1.25
32	For ø25	M10 x 1.25
	For ø32	M10 x 1.25
40	For ø40	M14 x 1.5

Operating conditions

Operating pressure	Pneumatic cylinder: 0.7 MPa or less
Mounting	Basic
Operating temperature	-10 to 70°C

Dimensions

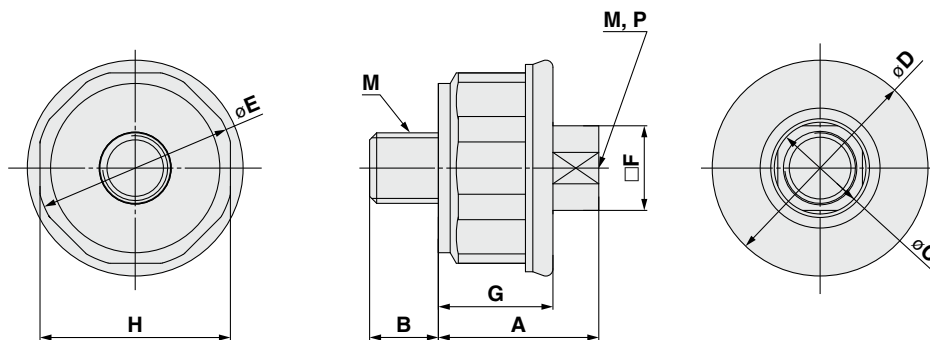

Standard Pneumatic: Up to 0.7 MPa

Model	Connection thread M	A	B	øC	øD	øE	□F	G	Width across flats H	Maximum thread depth P	Weight
JT20	M8 x 1.25	19.2	8	11	(25.4)	23	10	13.6	22	9.5	22 g
JT32	M10 x 1.25	23	10	13.4	(30.6)	28	12	16.3	27	11.5	38 g
JT40	M14 x 1.5	29	14	19	(40.4)	37.4	17	20.3	36	15.5	98 g

* Value in () is the dimension when the dust cover is used.

For details other than the above, and specific product precautions, refer to the **Web Catalog** for the JT series.



JCM Series

Specific Product Precautions

Be sure to read this before handling the products. Refer to the back cover for safety instructions. For actuator and auto switch precautions, refer to “Handling Precautions for SMC Products” and the “Operation Manual” on the SMC website: <https://www.smcworld.com>

Handling

Warning

1. Do not rotate the cover.

If a cover is rotated when installing a cylinder or screwing a fitting into the port, it is likely to damage the joint of the cover.

2. Operate the cylinder within the specified cylinder speed, kinetic energy, and lateral load at the rod end.

3. The allowable kinetic energy is different between the cylinders with male rod ends and with female rod ends due to the different thread sizes. Refer to page 6.

4. When a female rod end is used, depending on the material of the workpiece, use a washer etc. to prevent the contact part at the rod end from being deformed.

5. Do not apply excessive lateral loads to the piston rod.

Easy checking method

Minimum operating pressure after the cylinder is mounted to the equipment (MPa) = Minimum operating pressure of cylinder (MPa) + {Load mass (kg) x Friction coefficient of guide/Sectional area of cylinder (mm²)}

If smooth operation is confirmed within the above value, the load on the cylinder is the resistance of the thrust only and it can be judged as having no lateral load.

6. Do not apply any torque to the cover joint.

The rod cover and head cover have wrench flats with sufficient width. Apply an appropriate tightening force during mounting. Avoid working in a way such that one cover is secured and torque is applied to the other cover.

7. Do not hit or grasp the sliding parts of the cylinder tube and piston rod with other objects.

Cylinder bores are manufactured to precise tolerances, so that even a slight deformation may cause a malfunction.

Moreover, scratches, dents, etc. in the piston rod may lead to damaged seals and cause air leakage.

8. Tighten the mounting bracket within the recommended tightening torque range.

When mounting the bracket, tighten the mounting nut within the recommended tightening torque range shown in the table below.

Bore size [mm]	Tightening torque [N·m]
20	10.21 to 12.48
25, 32	20.66 to 25.25
40	35.54 to 43.44

Caution

1. Cannot be disassembled.

Cover and cylinder tube are connected to each other by caulking method, thus making it impossible to disassemble. Seals cannot be replaced.

2. Do not touch the cylinder during operation.

Use caution when handling a cylinder, which is running at a high speed and a high frequency, because the surface of the cylinder tube could get hot enough to burn you.

3. Do not use the air cylinder as an air-hydro cylinder.

The use of turbine oil as a fluid for an air cylinder may result in oil leakage.

4. The oil stuck to the cylinder is grease.

5. The base oil of the grease may seep out.

The base oil of the grease in the cylinder may seep out of the tube, cover, crimped part, or rod bushing depending on the operating conditions (ambient temperature 40°C or more, pressurized condition, low frequency operation).

6. Use a thin wrench when tightening the piston rod.

7. Depending on the system configuration selected, the specified speed may not be satisfied.

Safety Instructions

These safety instructions are intended to prevent hazardous situations and/or equipment damage. These instructions indicate the level of potential hazard with the labels of “**Caution**,” “**Warning**” or “**Danger**.” They are all important notes for safety and must be followed in addition to International Standards (ISO/IEC)*1), and other safety regulations.

 **Caution:** **Caution** indicates a hazard with a low level of risk which, if not avoided, could result in minor or moderate injury.

 **Warning:** **Warning** indicates a hazard with a medium level of risk which, if not avoided, could result in death or serious injury.

 **Danger :** **Danger** indicates a hazard with a high level of risk which, if not avoided, will result in death or serious injury.

*1) ISO 4414: Pneumatic fluid power – General rules relating to systems.
ISO 4413: Hydraulic fluid power – General rules relating to systems.
IEC 60204-1: Safety of machinery – Electrical equipment of machines.
(Part 1: General requirements)
ISO 10218-1: Manipulating industrial robots – Safety.
etc.

Warning

1. The compatibility of the product is the responsibility of the person who designs the equipment or decides its specifications.

Since the product specified here is used under various operating conditions, its compatibility with specific equipment must be decided by the person who designs the equipment or decides its specifications based on necessary analysis and test results. The expected performance and safety assurance of the equipment will be the responsibility of the person who has determined its compatibility with the product. This person should also continuously review all specifications of the product referring to its latest catalog information, with a view to giving due consideration to any possibility of equipment failure when configuring the equipment.

2. Only personnel with appropriate training should operate machinery and equipment.

The product specified here may become unsafe if handled incorrectly. The assembly, operation and maintenance of machines or equipment including our products must be performed by an operator who is appropriately trained and experienced.

3. Do not service or attempt to remove product and machinery/equipment until safety is confirmed.

1. The inspection and maintenance of machinery/equipment should only be performed after measures to prevent falling or runaway of the driven objects have been confirmed.
2. When the product is to be removed, confirm that the safety measures as mentioned above are implemented and the power from any appropriate source is cut, and read and understand the specific product precautions of all relevant products carefully.
3. Before machinery/equipment is restarted, take measures to prevent unexpected operation and malfunction.

4. Contact SMC beforehand and take special consideration of safety measures if the product is to be used in any of the following conditions.

1. Conditions and environments outside of the given specifications, or use outdoors or in a place exposed to direct sunlight.
2. Installation on equipment in conjunction with atomic energy, railways, air navigation, space, shipping, vehicles, military, medical treatment, combustion and recreation, or equipment in contact with food and beverages, emergency stop circuits, clutch and brake circuits in press applications, safety equipment or other applications unsuitable for the standard specifications described in the product catalog.
3. An application which could have negative effects on people, property, or animals requiring special safety analysis.
4. Use in an interlock circuit, which requires the provision of double interlock for possible failure by using a mechanical protective function, and periodical checks to confirm proper operation.

Caution

1. The product is provided for use in manufacturing industries.

The product herein described is basically provided for peaceful use in manufacturing industries.
If considering using the product in other industries, consult SMC beforehand and exchange specifications or a contract if necessary.
If anything is unclear, contact your nearest sales branch.

Limited warranty and Disclaimer/ Compliance Requirements

The product used is subject to the following “Limited warranty and Disclaimer” and “Compliance Requirements”.

Read and accept them before using the product.

Limited warranty and Disclaimer

1. The warranty period of the product is 1 year in service or 1.5 years after the product is delivered, whichever is first.*2)
Also, the product may have specified durability, running distance or replacement parts. Please consult your nearest sales branch.
2. For any failure or damage reported within the warranty period which is clearly our responsibility, a replacement product or necessary parts will be provided.
This limited warranty applies only to our product independently, and not to any other damage incurred due to the failure of the product.
3. Prior to using SMC products, please read and understand the warranty terms and disclaimers noted in the specified catalog for the particular products.

*2) Vacuum pads are excluded from this 1 year warranty.

A vacuum pad is a consumable part, so it is warranted for a year after it is delivered.
Also, even within the warranty period, the wear of a product due to the use of the vacuum pad or failure due to the deterioration of rubber material are not covered by the limited warranty.

Compliance Requirements

1. The use of SMC products with production equipment for the manufacture of weapons of mass destruction (WMD) or any other weapon is strictly prohibited.
2. The exports of SMC products or technology from one country to another are governed by the relevant security laws and regulations of the countries involved in the transaction. Prior to the shipment of a SMC product to another country, assure that all local rules governing that export are known and followed.

Caution

SMC products are not intended for use as instruments for legal metrology.

Measurement instruments that SMC manufactures or sells have not been qualified by type approval tests relevant to the metrology (measurement) laws of each country. Therefore, SMC products cannot be used for business or certification ordained by the metrology (measurement) laws of each country.

Revision History

Edition B	* Port thread NPT1/8 has been added.	UR
Edition C	* Changed to the new type auto switch mounting bracket. * Floating joints of related components have been added. * Number of pages has been increased from 16 to 20.	UX
Edition D	* An axial foot type and a flange type have been added to mounting brackets.	ZT

Safety Instructions

Be sure to read the “Handling Precautions for SMC Products” (M-E03-3) and “Operation Manual” before use.