

Cylinder with Lock

RoHS

∅32, ∅40, ∅50, ∅63, ∅80, ∅100

Lock can be manually operated with a hexagon wrench.

Can be easily mounted onto equipment

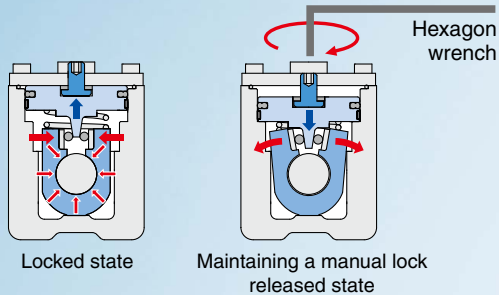

- Bore sizes ∅80 and ∅100 have been added.
- Lock units 80 and 100 have been added.
(Applicable rod size: ∅25, ∅30)

○ Separable construction for improved ease of maintenance

The lock unit and the cylinder can be separated.
This allows for easier maintenance.



○ Holding force improved by **15%**

(MNB, ∅50: 1370 N → **MWB: 1570 N**)

○ High stopping accuracy within **±1 mm**

(With ∅50 and 30 kg of load)

○ Overall length reduced by **18 mm max.**

(Compared with an MNB, ∅80, 100 mm stroke)

Lock Unit

Applicable for rod sizes ∅12 to ∅30



MWB Series

SMC

CAT.ES20-246D

A locking cylinder ideal for intermediate stops, emergency stops, and drop prevention

- Built-in manual lock release holding mechanism
- It is possible to release the locked state with a hexagon wrench and hold the released state without pressurizing the unlock port.
- Simple construction
- The condition of the lock release bolt allows for visual confirmation of whether the cylinder is in a locked or manual lock released state.

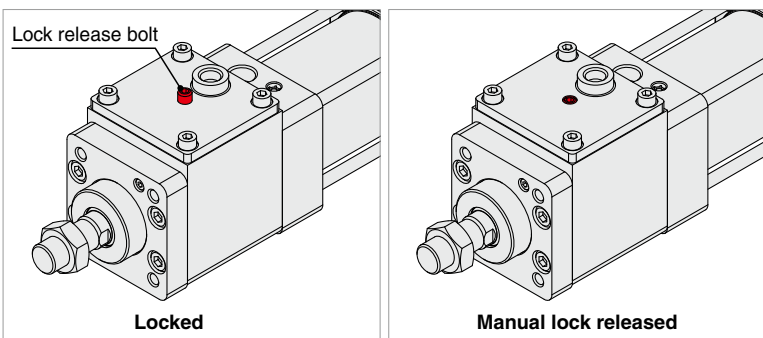
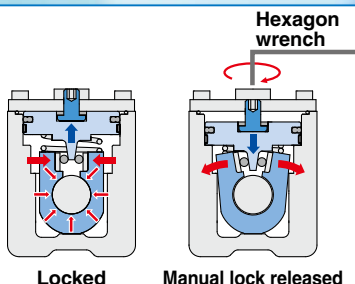

Refer to page 41 for the manual lock release.

Overall length reduced by **18 mm max.**

Up to 18 mm shorter compared with the MNB series

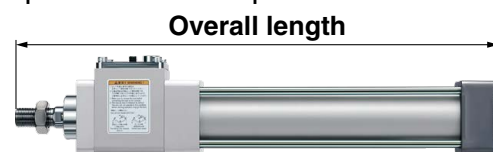

Overall length reduced [mm]			
Bore size [mm]	MWB	MNB	Reduction
32	194	205	11
40	212	216	4
50	234	245	11
63	246	259	13
80	303	321	18
100	323	341	18

* For basic type dimensions

Cylinders dimensionally compatible with the MNB series are available.

(Made to order individual specifications: -X3000)

Refer to page 35 for details.

Unlock port

When pressurized: Unlocked
When exhausted: Locked



Improved holding force
Improved by up to **15%** compared with the MNB series

Improved holding force [N]			
Bore size [mm]	MWB	MNB	Increase rate [%]
32	630	552	14
40	980	882	11
50	1570	1370	15
63	2450	2160	13
80	3920	3430	14
100	6080	5390	13

Compact auto switches are mountable.

- Solid state auto switch: D-M9□
- Reed auto switch: D-A9□
- Magnetic field-resistant auto switch: D-P3DWA, D-P4DW



The lock unit and the cylinder are separable in order to improve maintainability.



Lock Unit (page 32)

Can be used in combination with an actuator



Part numbers for products with a rod end bracket and/or a pivot bracket are available.

It is not necessary to order a bracket for the applicable cylinder separately.

* Rod end brackets and pivot brackets are shipped together with the product, but not assembled.

Example) **MDWB** **D** 40-100- **N** **V** -M9BW

• Mounting

Pivot bracket

Nil	No bracket
N	Pivot bracket is shipped together with the product, but not assembled.

* Applicable only to D (Double clevis) and T (Center trunnion) mounting types

Double clevis



Center trunnion



Rod end bracket

Nil	No bracket
V	Single knuckle joint
W	Double knuckle joint

With rod end bracket

V: Single knuckle joint **W:** Double knuckle joint



Series Variations

Cylinder with Lock

	Bore size [mm]	Lock holding force [N]	Cushion	Rod boot	Made to order
Single rod 	32	630 to 6080	• Air cushion • Rubber bumper	• Nylon tarpaulin • Heat-resistant tarpaulin	• Change of rod end shape (Single rod only) • With coil scraper • Made of stainless steel • Dimensionally compatible with the MNB series (Air cushion only)
	40				
	50				
	63				
	80				
Double rod 	100				

Lock Unit

A safety mechanism can be designed if required.
It can also be combined with a wide variety of actuators.

- Prevents the workpiece from falling
- Retains the workpiece position even when the air supply is shut off due to power failure, etc.



Lock unit model	MWB□32-UT	MWB□40-UT	MWB□50-UT	MWB□63-UT	MWB□80-UT	MWB□100-UT
Applicable rod size [mm]*1	ø12 f8	ø16 f8	ø20 f8	ø20 f8	ø25 f8	ø30 f8
Bore size of combinable cylinder [mm]	ø32	ø40	ø50	ø63	ø80	ø100
Lock holding force*2 (Max. static load) [N]	630	980	1,570	2,450	3,920	6,080
Made to order common specifications	Change of rod end shape (-XA), With coil scraper (-XC35), Made of stainless steel (-XC68)					

*1 The applicable rod size affects the holding force, so use a rod with the rod size tolerance shown in the table above.

*2 The holding force (max. static load) shows the maximum capability and does not show the normal holding capability. Be sure to select a cylinder using the method described in Model Selection (page 5).

* When inserting the rod into the lock unit, be sure to avoid damaging the seal and inner periphery of the product. For details, refer to page 44.

Part numbers for lock units with an applicable rod are now available.

It is not necessary to order a rod for the lock unit separately.

* Rod is shipped together with the product.

Example) **MWB B 40 - UT - 500**

Lock unit

Rod length

* Refer to page 32 for details on rod lengths.

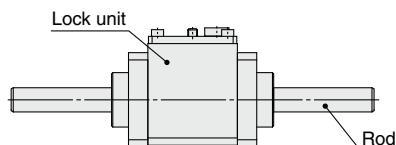

Application Example

Example of combination with a rodless cylinder

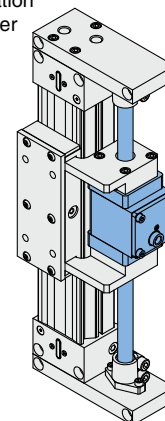

CONTENTS

Cylinder with Lock *MWB Series*

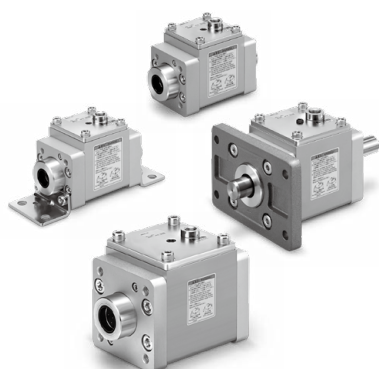
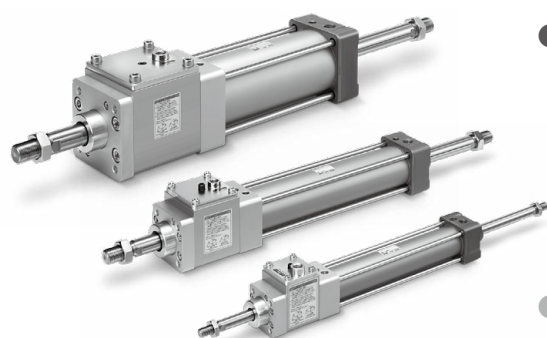
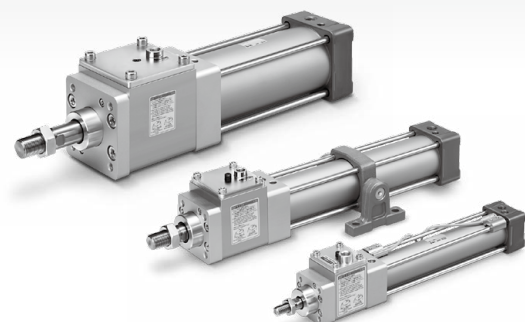

Model Selection	p. 5
● MWB Series/Single Rod	
How to Order	p. 7
Specifications	p. 8
Working Principle	p. 10
Construction	p. 11
Dimensions	p. 12
● MWBW Series/Double Rod	
How to Order	p. 17
Specifications	p. 18
Construction	p. 20
Dimensions	p. 21
● Auto Switch Mounting	
p. 24	
● MWB-UT Series/Lock Unit	
How to Order/Specifications	p. 32
Construction	p. 33
Dimensions	p. 34
● Made to Order Individual Specifications	
Dimensionally Compatible with the MNB Series (-X3000)	p. 35
With Lock Status Indication (-X3030□)	p. 35-1
● Simple Specials	
p. 36	
Change of Rod End Shape (-XA0 to XA30)	
● Made to Order Common Specifications	
p. 38	
With Coil Scraper (-XC35)	
Made of Stainless Steel	
(For Lock Unit, With Hard Chrome Plating) (-XC68)	
● Specific Product Precautions	
p. 39	

Model Selection

Double Acting, Single Rod
MWB

Double Acting, Double Rod
MWBW

Lock Unit
MWB-UT

Auto Switch

Made to Order

MWB Series Model Selection

Precautions on Model Selection

⚠ Caution

1. In order that the originally selected maximum speed shall not be exceeded, be certain to use a speed controller to adjust the total movement distance of the load so that movement takes place in no less than the applicable movement time. The movement time is the time that is necessary for the load to travel the total movement distance from the start without any intermediate stops.
2. In cases where the cylinder stroke and the movement distance of the load are different (double speed mechanism etc.), use the movement distance of the load for selection purposes.

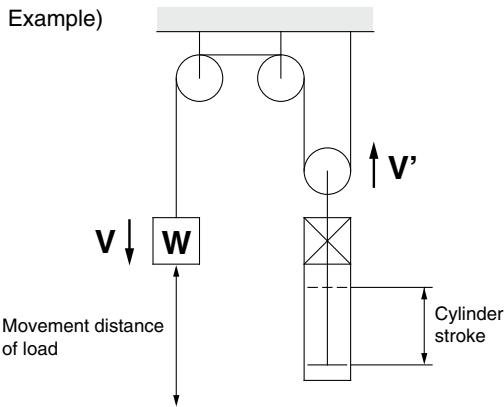

3. The following selection example and procedures are based on use at the intermediate stop (including emergency stops during operation). However, when the cylinder is in a locked state, kinetic energy does not act upon it. Under these conditions, use the load mass at the maximum speed (V) of 100 mm/s shown in graphs [5] to [7] on page 6 depending on the operating pressure and select models.

Selection Example

- Load mass : $m = 50 \text{ kg}$
- Movement distance : $st = 500 \text{ mm}$
- Movement time : $t = 2 \text{ s}$
- Load condition : Vertical downward = Load in direction of rod extension
- Operating pressure : $P = 0.4 \text{ MPa}$

Step 1: From graph [1], find the maximum movement speed of the load
 \therefore Maximum speed : $V \approx 350 \text{ mm/s}$.

Step 2: Select graph [6] based upon the load conditions and operating pressure, and then from the intersection of the maximum speed $V = 350 \text{ mm/s}$ found in Step 1, and the load mass $m = 50 \text{ kg}$.
 $\therefore \phi 63 \rightarrow$ Select an MWB63 or larger bore size.

Step 1 Find the maximum load speed V .

Find the maximum load speed: V [mm/s] from the load movement time: t [s] and the movement distance: st [mm].

Graph [1]

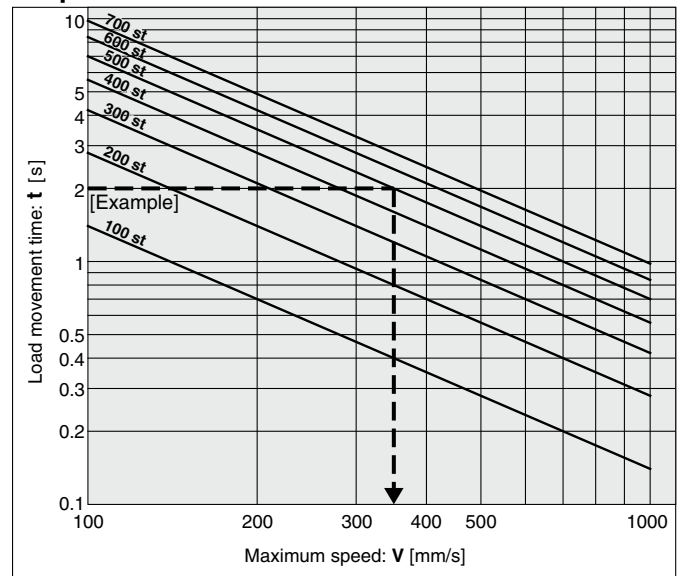

Step 2 Find the bore size.

Select a graph based upon the load condition and operating pressure, and then find the point of intersection for the maximum speed found in Step 1 and the load mass. Select the bore size on the above the point of intersection.

Load Condition

Operating Pressure

Load in the direction at the right angle to rod

(* Being held by a guide)

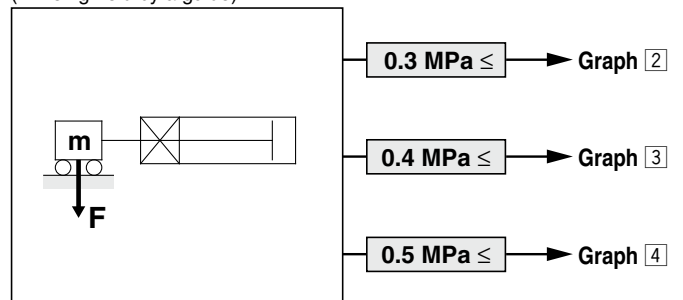

Load in the direction of rod extension

Load in the direction of rod retraction

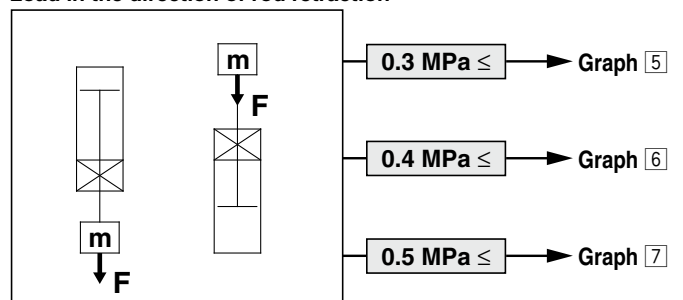

Selection Graph

Graph 2 $0.3 \text{ MPa} \leq P < 0.4 \text{ MPa}$

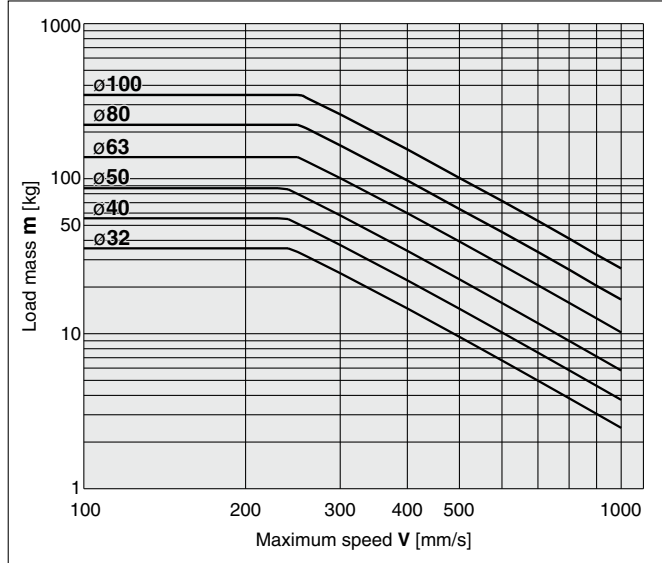

Graph 5 $0.3 \text{ MPa} \leq P < 0.4 \text{ MPa}$

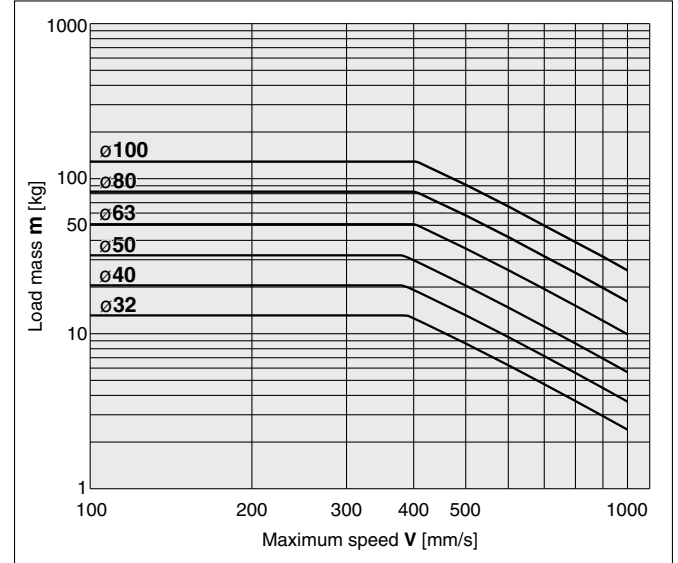

Graph 3 $0.4 \text{ MPa} \leq P < 0.5 \text{ MPa}$

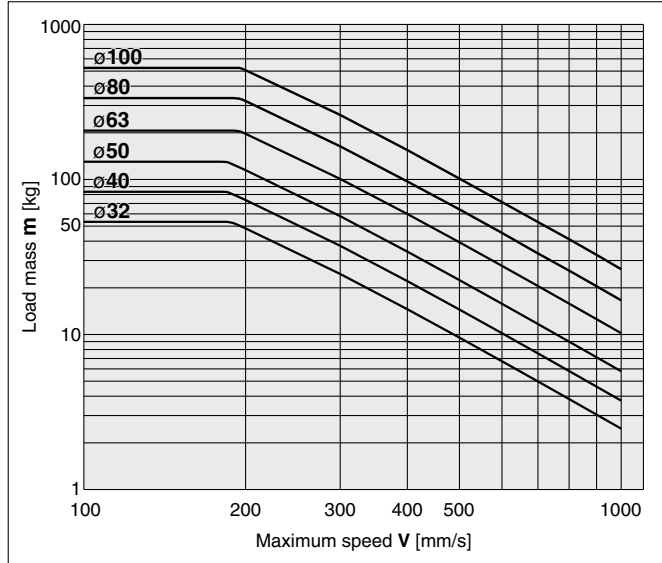

Graph 6 $0.4 \text{ MPa} \leq P < 0.5 \text{ MPa}$

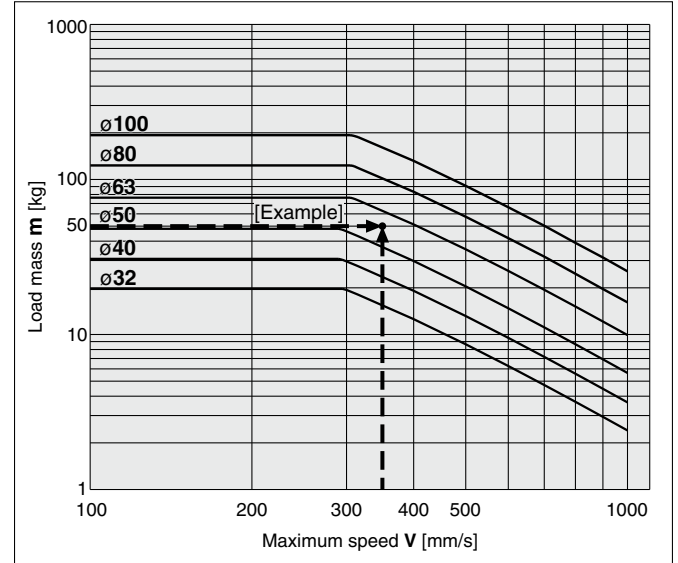

Graph 4 $0.5 \text{ MPa} \leq P$

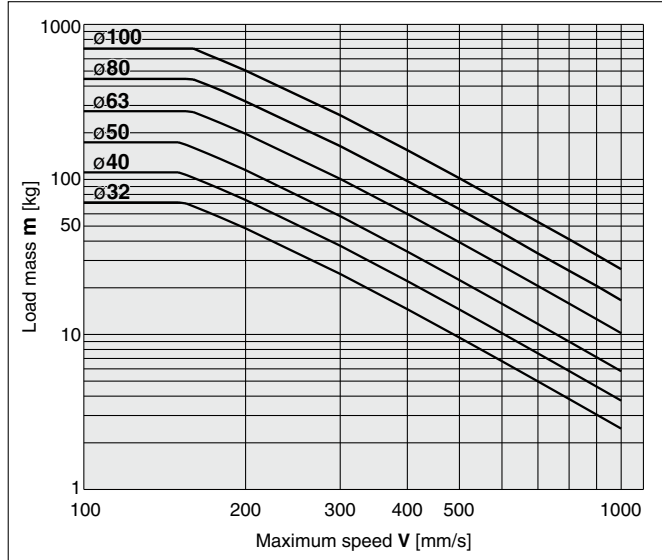

Graph 7 $0.5 \text{ MPa} \leq P$

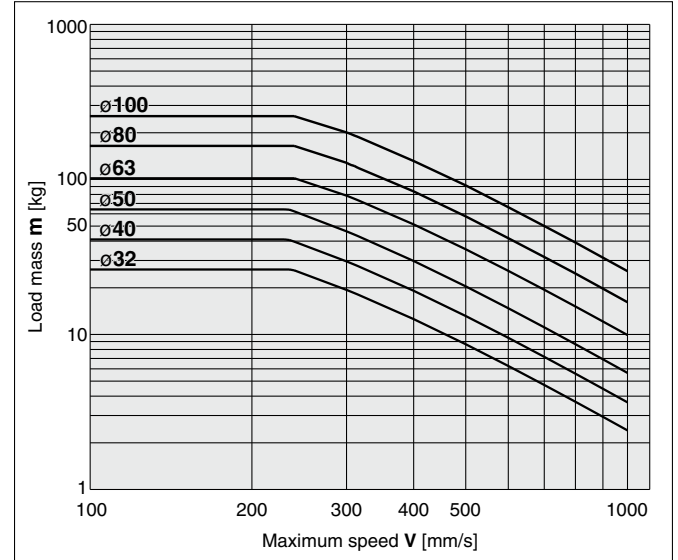

Model Selection

Double Acting, Single Rod

MWB

Double Acting, Double Rod

MWBW

Lock Unit

MWB-UT

Auto Switch

Made to Order

Cylinder with Lock

Double Acting, Single Rod

MWB Series

∅32, ∅40, ∅50, ∅63, ∅80, ∅100



How to Order

MWB B 40 [] - **50** [] [] - [] [] - [] []

With auto switch MDWB B 40 [] - **50** [] [] - [] [] - **M9BW** [] - [] []

With auto switch (Built-in magnet)

Mounting

B	Basic
L	Axial foot
F	Rod flange
G	Head flange
C	Single clevis
D	Double clevis
T	Center trunnion

* Mounting brackets other than center trunnion type are shipped together.

Bore size

32	32 mm
40	40 mm
50	50 mm
63	63 mm
80	80 mm
100	100 mm

Port thread type

Nil	Rc
TN	NPT
TF	G

Cylinder stroke [mm]

Refer to page 8 for standard strokes.

Suffix (Rod boot)

Nil	None
J	Nylon tarpaulin
K	Heat-resistant tarpaulin

Pivot bracket

Nil	No bracket
N	Pivot bracket

* Only for D and T mounting types.
* Pivot bracket is shipped together with the product.
* For details, refer to page 15.

Suffix (Cushion)

Nil	Air cushion
N*1	Rubber bumper

*1 Since the bumpers are attached to the both sides of the piston for rubber bumper type, the overall length is longer than the cylinder with air cushion as follows: ∅32, ∅40: +6 mm, ∅50, ∅63: +8 mm, ∅80, ∅100: +10 mm.

Auto switch

Nil	Without auto switch
-----	---------------------

* For applicable auto switches, refer to the table below.

Number of auto switches

Nil	2
S	1
3	3
n	n

Rod end bracket

Nil	No bracket
V	Single knuckle joint
W	Double knuckle joint

* A knuckle joint pin is not provided with the single knuckle joint.
* Rod end bracket is shipped together with the product.
* Excludes made to order -XA□.

Made to order

For details, refer to page 8.

Refer to the Ordering Example of Cylinder Assembly on page 8.

Applicable Auto Switches/Refer to the Web Catalog for further information on auto switches.

Type	Special function	Electrical entry	Indicator light	Wiring (Output)	Load voltage		Auto switch model		Lead wire length [m]				Pre-wired connector	Applicable load			
					DC	AC	Tie-rod mounting	Band mounting	0.5 (Nil)	1 (M)	3 (L)	5 (Z)					
Solid state auto switch	—	Grommet	—	3-wire (NPN)	24 V	5 V, 12 V	—	M9N	●	●	●	○	—	IC circuit	Relay, PLC		
				3-wire (PNP)				M9P	●	●	●	○					
		2-wire		M9B	●	●	●	○	○								
		Terminal conduit		3-wire (NPN)	24 V	5 V, 12 V	—	—	G39	—	—	—	—	—		—	
	2-wire	—	K39	—				—	—	—	—						
	Diagnostic indication (2-color indicator)	Grommet	Yes	3-wire (NPN)	24 V	5 V, 12 V	—	M9NW	●	●	●	○	○	—		IC circuit	
				3-wire (PNP)				M9PW	●	●	●	○	○	—			
	Water-resistant (2-color indicator)	Grommet	—	3-wire (NPN)	24 V	5 V, 12 V	—	M9NA*1	○	○	●	○	○	—		IC circuit	
				3-wire (PNP)				M9PA*1	○	○	●	○	○	—			
	With diagnostic output (2-color indicator)	Grommet	—	2-wire	24 V	12 V	—	M9BW	●	●	●	○	○	—		—	
3-wire (NPN)				M9NA*1				○	○	●	○	○	—				
Magnetic field-resistant (2-color indicator)	Grommet	—	3-wire (PNP)	24 V	5 V, 12 V	—	M9BA*1	○	○	●	○	○	—	—			
			2-wire				F59F	●	—	●	○	○	—	IC circuit			
Reed auto switch	—	Grommet	Yes	3-wire (NPN equivalent)	24 V	5 V	—	A96	●	—	●	—	—	—	IC circuit		
				No				100 V	A93	●	●	●	●	—	—		
				Yes				100 V or less	A90	●	—	●	—	—	—	IC circuit	
				No				100 V, 200 V	A54	●	—	●	●	—	—		
		Terminal conduit	Yes	2-wire	24 V	12 V	—	—	A64	●	—	●	—	—	—	—	
									—	A33	—	—	—	—	—	—	
		DIN terminal	Yes	2-wire	24 V	12 V	—	100 V, 200 V	—	A34	—	—	—	—	—	—	
									—	A44	—	—	—	—	—	—	
		Diagnostic indication (2-color indicator)	Grommet	—	—	24 V	—	—	—	A59W	●	—	●	—	—	—	—
										—	—	—	—	—	—	—	—

*1 Water-resistant type auto switches can be mounted on the above models, but SMC cannot guarantee water resistance. A water-resistant type cylinder is recommended for use in an environment which requires water resistance.

* Lead wire length symbols: 0.5 m.....Nil (Example) M9NW 3 m.....L (Example) M9NWL
1 m.....M (Example) M9NWM 5 m.....Z (Example) M9NWZ

* Solid state auto switches marked with "○" are produced upon receipt of order.

* Since there are applicable auto switches other than those listed above, refer to page 30 for details.

* The D-A9□/M9□/P3DWA□ auto switches are shipped together, but not assembled. (Only the auto switch mounting brackets are assembled for the D-A9□/M9□ before shipment.)

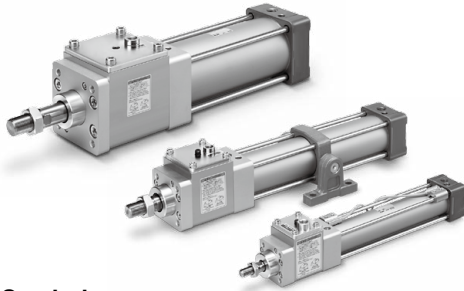

Symbol

Rubber bumper

Air cushion

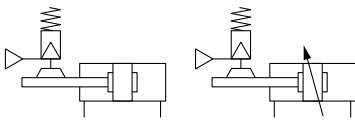

Made to Order Individual Specifications (For details, refer to pages 35 to 35-4.)

Symbol	Specifications
-X3000	Dimensionally compatible with the MNB series
-X3030	With lock status indication
-X3075	ISO 13849-1 safety standard compliant product / Cylinder with brake/lock unit

Made to Order Common Specifications [Click here for details.](#)

Symbol	Specifications
-XA	Change of rod end shape
-XC35	With coil scraper

For details of **cylinders with auto switches**
⇒ pages 24 to 30

- Auto Switch Proper Mounting Position (Detection at stroke end) and Mounting Height
- Minimum Stroke for Auto Switch Mounting
- Auto Switch Mounting Brackets/Part Nos.
- Operating Range

Ordering Example of Cylinder Assembly

Cylinder model: MDWBD32-50-NW-M9BW

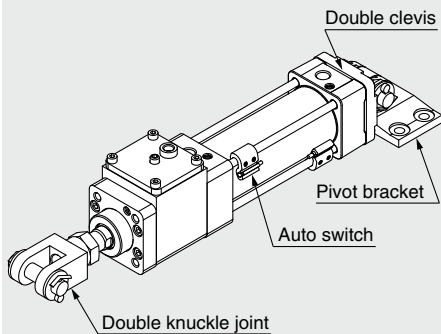

Mounting D: Double clevis
Pivot bracket N: Yes
Rod end bracket W: Double knuckle joint
Auto switch D-M9BW: 2 pcs.

* Pivot bracket, double knuckle joint, and auto switch are shipped together with the product, but not assembled.

Cylinder Specifications

Bore size [mm]	32	40	50	63	80	100
Action	Double acting, Single rod					
Fluid	Air					
Proof pressure	1.5 MPa					
Max. operating pressure	1.0 MPa					
Min. operating pressure	0.08 MPa					
Ambient and fluid temperatures	Without auto switch: -10°C to 70°C With auto switch: -10°C to 60°C (No freezing)					
Lubricant	Not required (Non-lube)					
Piston speed	50 to 1000 mm/s*1					
Stroke length tolerance	Up to 250 st: $^{+1.0}_0$, 251 to 1000 st: $^{+1.4}_0$, 1001 to 1500 st: $^{+1.8}_0$, 1501 to 2000 st: $^{+2.2}_0$					
Cushion	Air cushion or Rubber bumper					
Port size (Rc, NPT, G)	1/8	1/4	3/8		1/2	
Mounting	Basic, Axial foot, Rod flange, Head flange Single clevis, Double clevis, Center trunnion					

*1 Load limits exist depending upon the piston speed when locked, mounting direction, and operating pressure.

Lock Unit Specifications

Bore size [mm]	32	40	50	63	80	100
Locking action	Exhaust locking					
Max. operating pressure	1.0 MPa					
Min. operating pressure	0.3 MPa					
Locking direction	Both directions					
Holding force (Max. static load) [N]*1	630	980	1570	2450	3920	6080

*1 The holding force (max. static load) shows the maximum capability and does not show the normal holding capability. Be sure to select a cylinder using the method described in Model Selection (page 5).

Standard Strokes

* When using with auto switches, refer to the Minimum Stroke for Auto Switch Mounting table on pages 26 to 28.

Bore size	Standard stroke		Max. manufacturable stroke
	Stroke range ①	Stroke range ②	
32	25, 50, 75, 100, 125, 150, 175, 200, 250, 300, 350, 400, 450, 500	Up to 1000	Up to 2500
40	25, 50, 75, 100, 125, 150, 175, 200, 250, 300, 350, 400, 450, 500	Up to 1800	
50	25, 50, 75, 100, 125, 150, 175, 200, 250, 300, 350, 400, 450, 500, 600		
63	25, 50, 75, 100, 125, 150, 175, 200, 250, 300, 350, 400, 450, 500, 600		
80	25, 50, 75, 100, 125, 150, 175, 200, 250, 300, 350, 400, 450, 500, 600, 700, 800		
100	25, 50, 75, 100, 125, 150, 175, 200, 250, 300, 350, 400, 450, 500, 600, 700, 800		

- * The manufacturing of intermediate strokes is possible. (Spacers are not used.)
- * Applicable strokes should be confirmed according to the usage. For details, refer to the Air Cylinders Model Selection in the **Web Catalog**. In addition, products that exceed the stroke range ① might not be able to fulfill the specifications due to deflection, etc.
- * Please consult with SMC for details on manufacturability and for part numbers when exceeding the stroke range ②.
- * When using a rod boot, a stroke range of up to 1000 mm is available. Please consult with SMC when exceeding a 1000 mm stroke.

Stopping Accuracy

Bore size [mm]	32	40	50	63	80	100
Lock type	Exhaust locking					
Stopping accuracy [mm]	±1.0					
Conditions	<ul style="list-style-type: none"> · Mounting orientation: Horizontal · Supply pressure: 0.5 MPa · Piston speed: 300 mm/s · Load condition: Upper limit of allowed value Solenoid valve for locking is mounted on the unlock port. Maximum value of stopping position dispersion from 100 measurements					

MWB Series

Accessories

Mounting		Basic	Axial foot	Rod flange	Head flange	Single clevis	Double clevis	Center trunnion
Standard	Rod end nut	●	●	●	●	●	●	●
	Clevis pin	—	—	—	—	—	●	—
Option	Single knuckle joint	●	●	●	●	●	●	●
	Double knuckle joint (with pin)	●	●	●	●	●	●	●
	Rod boot	●	●	●	●	●	●	●

* Refer to page 16 for dimensions and part numbers of the accessories. (Except rod boot)

Mounting Brackets/Part Nos.

Bore size [mm]	32	40	50	63	80	100
Axial foot*1	MB-L03	MB-L04	MB-L05	MNB-L06*	MB-L08	MB-L10
Rod/Head flange	MNB-F03*	MNB-F04*	MNB-F05*	MNB-F06*	MB-F08	MB-F10
Single clevis	MB-C03	MB-C04	MB-C05	MB-C06	MB-C08	MB-C10
Double clevis	MB-D03	MB-D04	MB-D05	MB-D06	MB-D08	MB-D10

*1 Order two foot brackets per cylinder.

* Accessories for each mounting bracket are as follows.

Axial foot, Rod/Head flange, Single clevis: Body mounting bolt

Double clevis: Clevis pin, Split pins, Flat washers and Body mounting bolt

* All are common to the MB series air cylinders, except the sections marked with a “*”.

Theoretical Output



(Unit: N)

Bore size [mm]	Rod size [mm]	Operating direction	Piston area [mm ²]	Operating pressure [MPa]								
				0.2	0.3	0.4	0.5	0.6	0.7	0.8	0.9	1.0
32	12	OUT	804	161	241	322	402	482	563	643	724	804
		IN	691	138	207	276	346	415	484	553	622	691
40	16	OUT	1257	251	377	503	629	754	880	1006	1131	1257
		IN	1056	211	317	422	528	634	739	845	950	1056
50	20	OUT	1963	393	589	785	982	1178	1374	1570	1767	1963
		IN	1649	330	495	660	825	989	1154	1319	1484	1649
63	20	OUT	3117	623	935	1247	1559	1870	2182	2494	2805	3117
		IN	2803	561	841	1121	1402	1682	1962	2242	2523	2803
80	25	OUT	5027	1005	1508	2011	2514	3016	3519	4022	4524	5027
		IN	4536	907	1361	1814	2268	2722	3175	3629	4082	4536
100	30	OUT	7854	1571	2356	3142	3927	4712	5498	6283	7069	7854
		IN	7147	1429	2144	2859	3574	4288	5003	5718	6432	7147

* Theoretical output [N] = Pressure [MPa] x Piston area [mm²]

Weight

Bore size [mm]		32	40	50	63	80	100
Basic weight (at 0 stroke)	Basic						
	Lock unit	0.42	0.83	1.15	1.79	2.81	5.44
	Cylinder (at 0 stroke)	0.43	0.70	1.16	1.51	2.80	4.36
Total		0.85	1.53	2.31	3.30	5.61	9.80
Mounting bracket weight (including bracket mounting bolts)	Foot bracket (2 pcs.)	0.12	0.14	0.22	0.26	0.50	0.66
	Rod/Head flange	0.24	0.32	0.53	0.74	1.45	1.83
	Single clevis bracket	0.25	0.23	0.34	0.63	1.11	1.58
	Double clevis bracket	0.26	0.27	0.43	0.79	1.40	1.85
	Trunnion bracket	0.29	0.36	0.48	0.80	1.55	1.69
Additional weight per 50 mm of stroke		0.11	0.16	0.26	0.27	0.42	0.56
Accessories	Single knuckle joint	0.15	0.23	0.26	0.26	0.60	0.83
	Double knuckle joint (with pin)	0.22	0.37	0.43	0.43	0.87	1.27

Rod Boot Material

Symbol	Material	Max. ambient temp.
J	Nylon tarpaulin	70°C
K	Heat-resistant tarpaulin	110°C*1

*1 Max. ambient temperature for rod boot itself

Allowable Kinetic Energy of the Cylinder*1

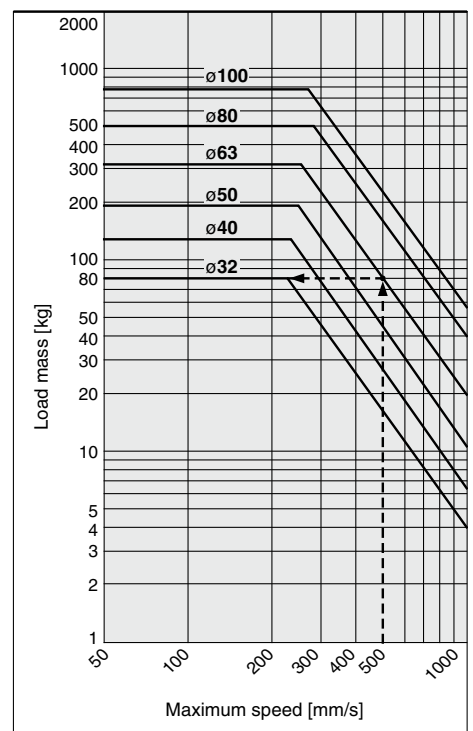

Example) Load limit at rod end when the air cylinder ø63 is actuated at 500 mm/s.

Extend upward from 500 mm/s on the horizontal axis of the graph to the intersection point with the line for a tube bore size of 63 mm, and then extend leftward from this point to find the load of 80 kg.

*1 The allowable kinetic energy of the cylinder is shown without the intermediate stop or emergency stop. Refer to page 5 or 6 for the kinetic energy with intermediate or emergency stop.

Calculation example)

MWBL32-100 (Axial foot, ø32, 100 mm stroke)

● Basic weight...0.42 (Lock unit, ø32)

● Basic weight...0.43 (Cylinder, ø32)

● Additional weight...0.11/50 mm stroke

● Cylinder stroke...100 mm stroke

● Foot bracket...0.12

0.42 + 0.43 + (0.11/50) x 100 + 0.12 = 1.19 kg

Working Principle

Normal operation (Operation pressurized by air)

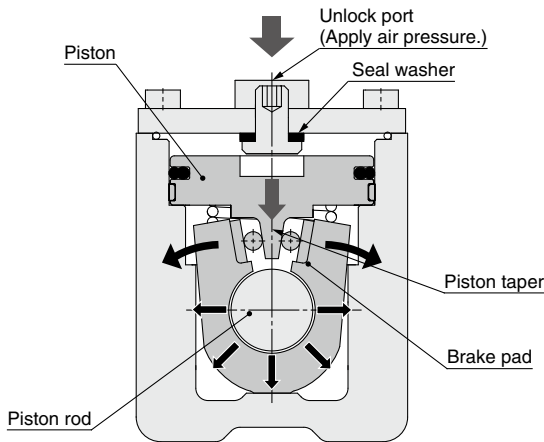

Unlocked (when air pressure is applied)

When air is supplied to the unlock port, the piston moves downward, the brake pad is opened by the tapered portion at the bottom of the piston and the piston rod will be free to move. This is the lock released state.

* Check that there is no air leakage from the unlock port.

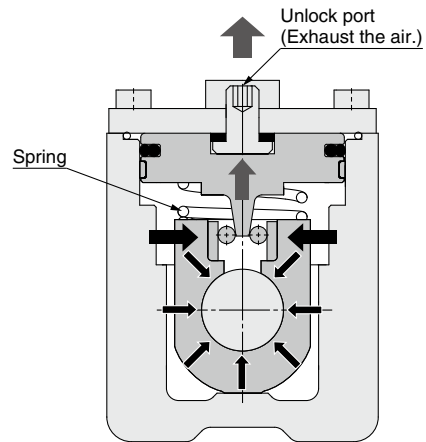

Locked (when air is exhausted)

When the air supplied to the unlock port is exhausted, the piston moves upward due to the spring force at the bottom of the piston and rigidity of the brake pad. Then, the brake pad is closed and holds the piston rod, locking its movement. This is the locked state.

Manual lock release

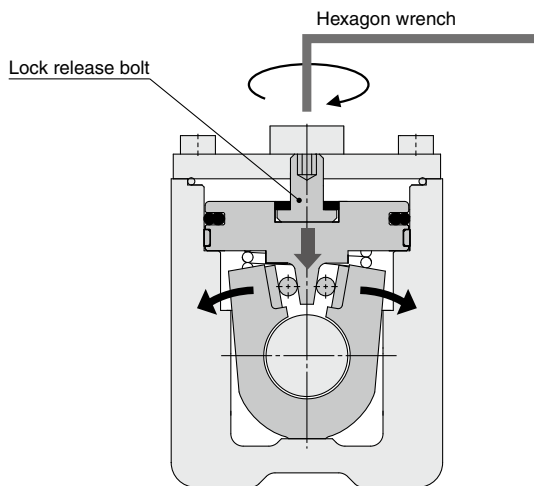

Manual lock released

When the lock release bolt is screwed-in, the piston moves downward, the brake pad is opened by the tapered portion of the piston and the piston rod will be freed. This holds the lock in the released state. Refer to page 41 for how to return to the locked state.

Model Selection

Double Acting, Single Rod
MWB

Double Acting, Double Rod
MWBW

Lock Unit
MWB-UT

Auto Switch

Made to Order

MWB Series

Construction

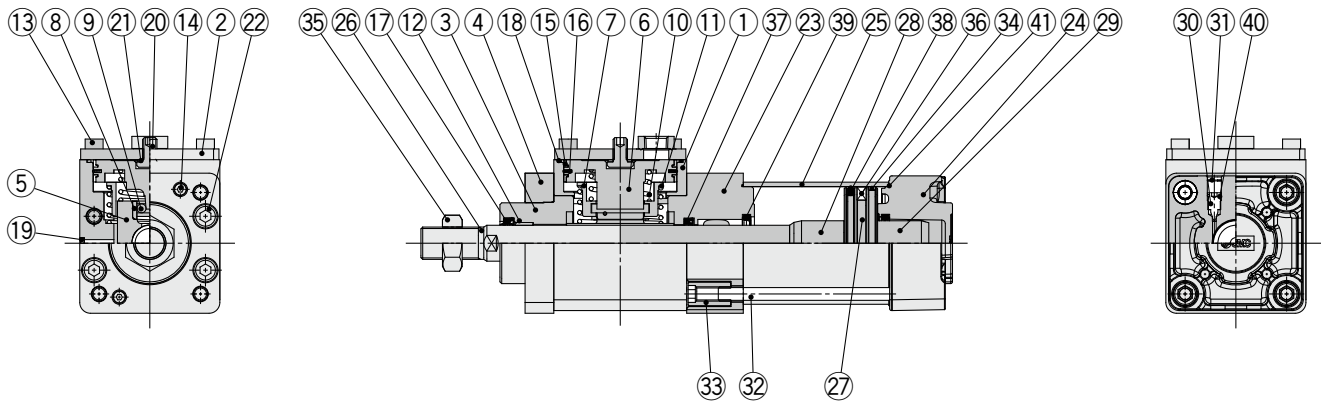

Component Parts

No.	Description	Material	Qty.	Note
1	Brake unit	Aluminum alloy	1	Hard anodized
2	Cap	Rolled steel	1	Zinc chromated
3	Collar	Aluminum alloy	1	Chromated
4	Retaining plate	Aluminum alloy	1	Anodized
5	Brake pad	Cast iron	1	
6	Piston A	Aluminum alloy	1	
7	Roller holder	Carbon steel	1	
8	Roller receiver	Stainless steel	2	Heat treated
9	Needle roller	Carbon steel	2	Heat treated
10	Piston spring	Spring steel	1	Zinc chromated
11	Roller spring	Spring steel	1	Zinc chromated
12	Bushing	Bearing alloy	1	
13	Hexagon socket head cap screw	Alloy steel	4	
14	Hexagon socket head cap screw	Alloy steel	2	
15	Wear ring A	Resin	2	
16	Piston seal A	NBR	1	
17	Rod seal A	NBR	1	
18	Gasket	NBR	1	
19	Element	Bronze	1	
20	Release bolt	Alloy steel	1	
21	Seal washer	NBR + Stainless steel	1	
22	Hexagon socket head cap screw	Alloy steel	4	
23	Rod cover	Aluminum alloy	1	Anodized
24	Head cover	Aluminum die-cast	1	Chromated
25	Cylinder tube	Aluminum alloy	1	Hard anodized
26	Piston rod	Carbon steel	1	Hard chrome plating
27	Piston B	Aluminum alloy	1	
28	Cushion ring	Aluminum alloy	1	Anodized
29	Cushion ring B	Aluminum alloy	1	Anodized

Component Parts

No.	Description	Material	Qty.	Note
30	Cushion valve	Steel wire	2	Zinc chromated
31	Retaining ring	Spring steel	2	ø40 to ø100
32	Tie-rod	Carbon steel	4	Zinc chromated
33	Tie-rod nut	Carbon steel	8	Zinc chromated
34	Wear ring B	Resin	1	
35	Rod end nut	Carbon steel	1	Zinc chromated
36	Magnet	—	(1)	
37	Rod seal B	NBR	1	
38	Piston seal B	NBR	1	
39	Cushion seal	Urethane	2	
40	Cushion valve seal	NBR	2	
41	Cylinder tube gasket	NBR	2	

Replacement Parts/Seal Kit

Bore size [mm]	Kit no.	Contents
32	MWB32-PS	A set of ⑰ Rod seal A, ⑳ Rod seal B, ㉑ Piston seal B, ㉒ Cushion seal, and ㉓ Cylinder tube gasket
40	MWB40-PS	
50	MWB50-PS	
63	MWB63-PS	
80	MWB80-PS	
100	MWB100-PS	

* Never disassemble the lock unit. It should be replaced as a unit. Refer to page 42 for the part numbers for placing an order. The seal kit shown above contains the rod seal for the cylinder and lock unit. Order the seal kit suitable for the cylinder bore size.

* The seal kit shown above includes a grease pack.
 (ø32, ø40, ø50: 10 g, ø63, ø80: 20 g, ø100: 30 g)
 Order with the following part number when only the grease pack is needed.
Grease pack part number: GR-S-010 (10 g), GR-S-020 (20 g)

Cylinder with Lock Double Acting, Single Rod **MWB Series**

Dimensions

Basic: MWBB

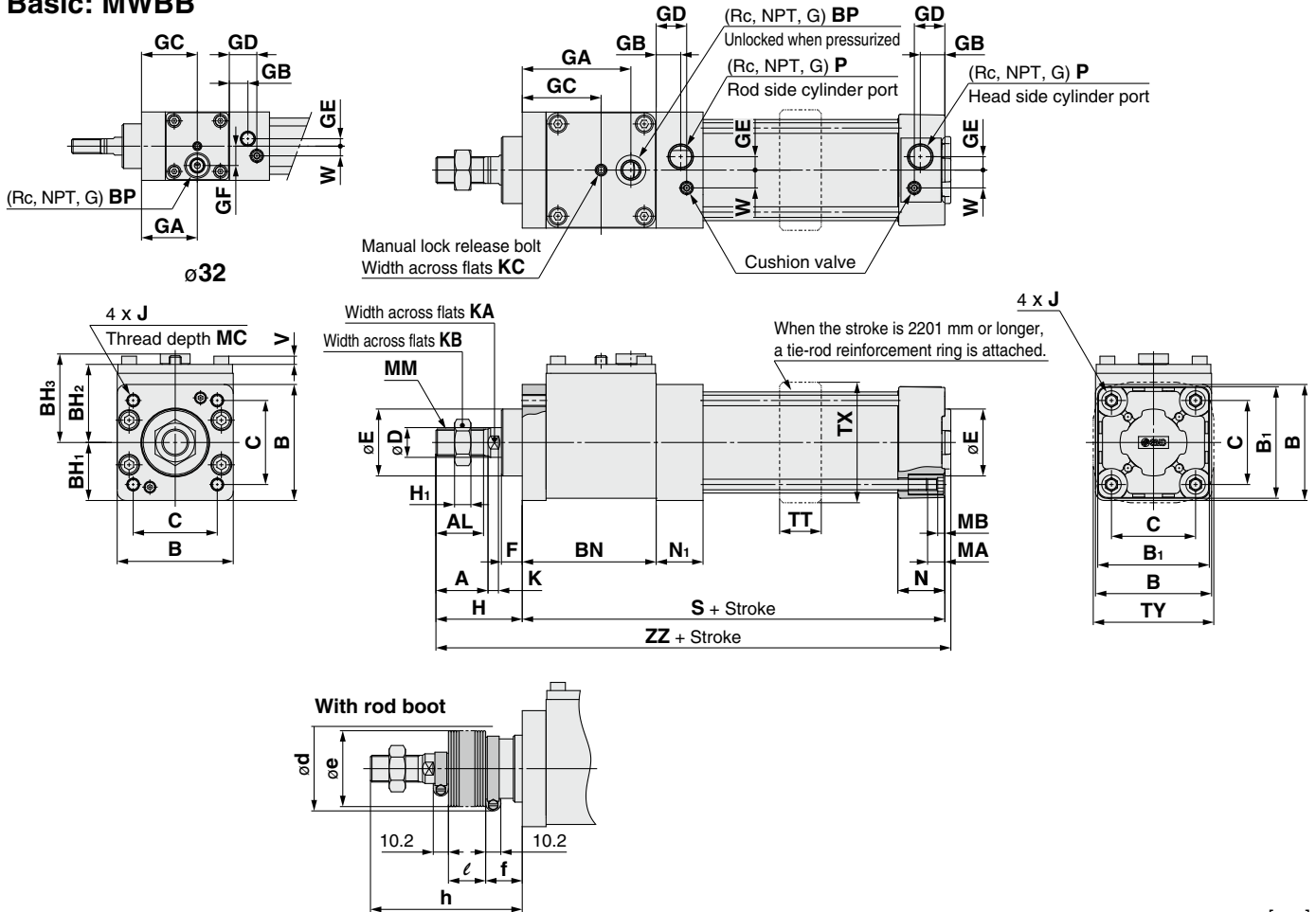

Bore size	A	AL	B	B ₁	BH ₁	BH ₂	BH ₃	BN	BP	C	D	E	F	GA	GB	GC	GD	GE	GF	H	H ₁	J
32	22	19.5	46	46	23	38.5	46.5	59	1/8	32.5	12	30	13	37.5	13	37.5	18.5	4	13	47	6	M6 x 1.0
40	30	27	57	52	28.5	42.5	48.5	73	1/8	38	16	35	13	59.5	14	44.5	19.5	4	—	51	8	M6 x 1.0
50	35	32	66	65	33	49	55.5	78	1/8	46.5	20	40	14	64	15.5	47	23	5	—	58	11	M8 x 1.25
63	35	32	78	75	39	52.5	59.5	90	1/4	56.5	20	45	14	73	16.5	53	20.5	9	—	58	11	M8 x 1.25
80	40	37	98	95	49	64.5	71.5	113	1/4	72	25	45	20	92	19	65	26	11.5	—	72	13	M10 x 1.5
100	40	37	116	114	58	73.5	80.5	131	1/4	89	30	55	20	109	19	74	26	17	—	72	16	M10 x 1.5

Bore size	K	KA	KB	KC	MA	MB	MC	MM	N	N ₁	P	S	TT	TX	TY	V	W	ZZ	With Rubber Bumper		
																			Bore size	S	ZZ
32	6	10	17	3	16	4	16	M10 x 1.25	27	27	1/8	143	17	48	49	3.5	6.5	194	32	149	200
40	6	14	22	3	16	4	16	M14 x 1.5	27	27	1/4	157	22	55	58	4.5	9	212	40	163	218
50	7	18	27	4	16	5	16	M18 x 1.5	31.5	31.5	1/4	172	22	68	71	4.5	10.5	234	50	180	242
63	7	18	27	4	16	5	16	M18 x 1.5	31.5	31.5	3/8	184	28	81	81	5.5	12	246	63	192	254
80	10	22	32	5	16	5	17	M22 x 1.5	38	38	3/8	227	34	102	102	7.5	14	303	80	237	313
100	10	26	41	5	16	5	17	M26 x 1.5	38	40	1/2	247	40	124	124	9.5	15	323	100	257	333

With Rod Boot

Bore size	d	e	f	ℓ											
				1 to 50	51 to 100	101 to 150	151 to 200	201 to 300	301 to 400	401 to 500	501 to 600	601 to 700	701 to 800	801 to 900	901 to 1000
32	54	36	23	12.5	25	37.5	50	75	100	125	150	175	—	—	—
40	56	41	23	12.5	25	37.5	50	75	100	125	150	175	200	—	—
50	64	51	25	12.5	25	37.5	50	75	100	125	150	175	200	225	250
63	64	51	25	12.5	25	37.5	50	75	100	125	150	175	200	225	250
80	68	56	29	12.5	25	37.5	50	75	100	125	150	175	200	225	250
100	76	61	29	12.5	25	37.5	50	75	100	125	150	175	200	225	250

Bore size	h											
	1 to 50	51 to 100	101 to 150	151 to 200	201 to 300	301 to 400	401 to 500	501 to 600	601 to 700	701 to 800	801 to 900	901 to 1000
32	73	86	98	111	136	161	186	211	236	—	—	—
40	81	94	106	119	144	169	194	219	244	269	—	—
50	89	102	114	127	152	177	202	227	252	277	302	327
63	89	102	114	127	152	177	202	227	252	277	302	327
80	101	114	126	139	164	189	214	239	264	289	314	339
100	101	114	126	139	164	189	214	239	264	289	314	339

Model Selection

Double Acting, Single Rod **MWB**

Double Acting, Double Rod **MWBW**

Lock Unit **MWB-U**

Auto Switch

Made to Order

MWB Series

Dimensions: With Mounting Bracket

* Refer to Basic (B) for other dimensions.

Axial foot: MWBL

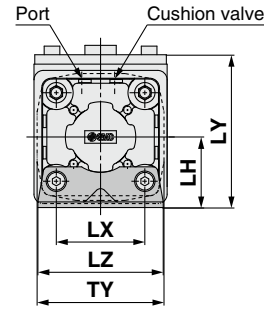
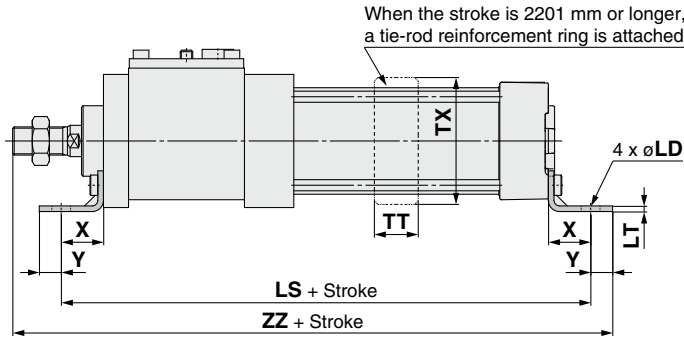

Bore size	LD	LH	LS	LT	LX	LY	LZ	TT	TX	TY	X	Y	ZZ
32	7	30	187	3.2	32	68.5	50	17	48	49	22	9	221
40	9	33	205	3.2	38	75.5	55	22	55	58	24	11	243
50	9	40	226	3.2	46	89	70	22	68	71	27	11	268
63	12	48	238	3.6	56	100.5	80	28	81	81	27	14	283
80	12	55	287	4.5	72	119.5	100	34	102	102	30	14	343
100	14	65	311	4.5	89	138.5	120	40	124	124	32	16	367

Bore size	LS	ZZ
32	193	227
40	211	249
50	234	276
63	246	291
80	297	353
100	321	377

Rod flange: MWBF

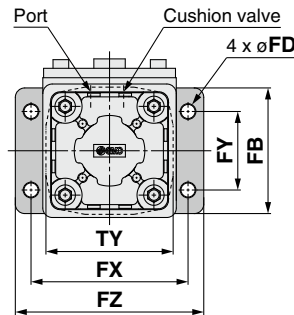
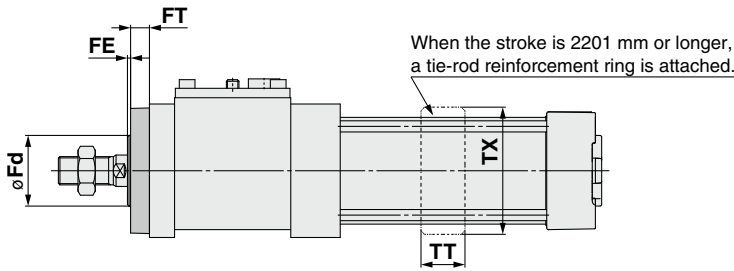

Bore size	FB	FD	Fd	FE	FT	FX	FY	FZ	TT	TX	TY
32	56	7	30	3	10	72	38	87	17	48	49
40	65	9	35	3	10	83	46	101	22	55	58
50	77	9	40	2	12	100	52	120	22	68	71
63	92	9	45	2	12	115	62	135	28	81	81
80	100	12	45	4	16	126	63	153	34	102	102
100	120	14	55	4	16	150	75	178	40	124	124

Head flange: MWBG

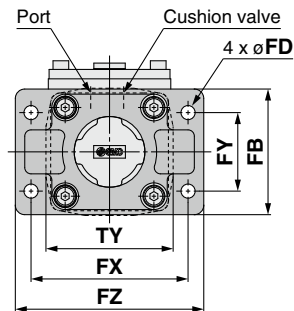
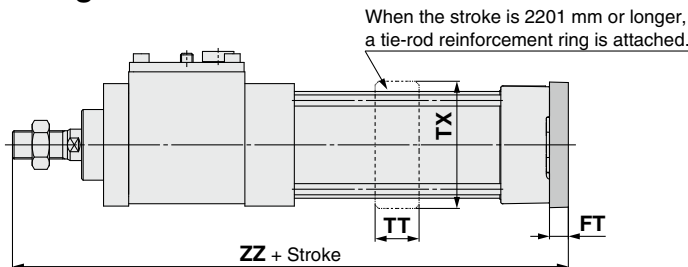

Bore size	FB	FD	FT	FX	FY	FZ	TT	TX	TY	ZZ
32	56	7	10	72	38	87	17	48	49	200
40	65	9	10	83	46	101	22	55	58	218
50	77	9	12	100	52	120	22	68	71	242
63	92	9	12	115	62	135	28	81	81	254
80	100	12	16	126	63	153	34	102	102	315
100	120	14	16	150	75	178	40	124	124	335

Bore size	ZZ
32	206
40	224
50	250
63	262
80	325
100	345

Dimensions: With Mounting Bracket

* Refer to Basic (B) for other dimensions.

Single clevis: MWBC

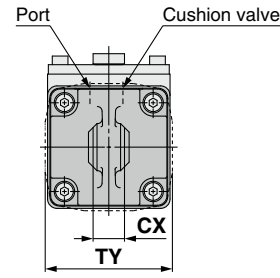
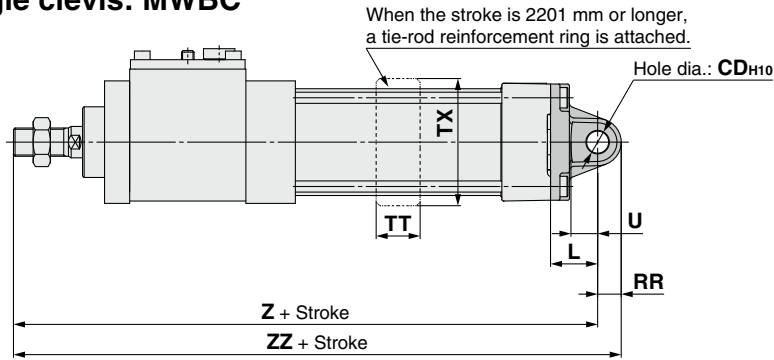

Bore size	CDH10	CX	L	RR	U	TT	TX	TY	Z	ZZ
32	10 ^{+0.058} ₀	14 ^{-0.1} _{-0.3}	23	10.5	13	17	48	49	213	223.5
40	10 ^{+0.058} ₀	14 ^{-0.1} _{-0.3}	23	11	13	22	55	58	231	242
50	14 ^{+0.070} ₀	20 ^{-0.1} _{-0.3}	30	15	17	22	68	71	260	275
63	14 ^{+0.070} ₀	20 ^{-0.1} _{-0.3}	30	15	17	28	81	81	272	287
80	22 ^{+0.084} ₀	30 ^{-0.1} _{-0.3}	42	23	26	34	102	102	341	364
100	22 ^{+0.084} ₀	30 ^{-0.1} _{-0.3}	42	23	26	40	124	124	361	384

With Rubber Bumper [mm]

Bore size	Z	ZZ
32	219	229.5
40	237	248
50	268	283
63	280	295
80	351	374
100	371	394

Double clevis: MWBD

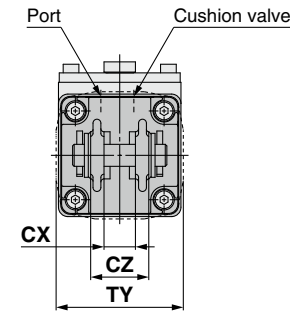
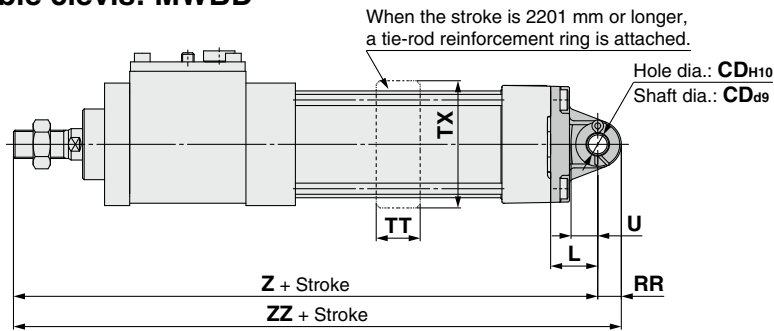

Bore size	CDH10	CDa9	CX	CZ	L	RR	U	TT	TX	TY	Z	ZZ
32	10 ^{+0.058} ₀	10 ^{-0.040} _{-0.076}	14 ^{+0.3} _{+0.1}	28	23	10.5	13	17	48	49	213	223.5
40	10 ^{+0.058} ₀	10 ^{-0.040} _{-0.076}	14 ^{+0.3} _{+0.1}	28	23	11	13	22	55	58	231	242
50	14 ^{+0.070} ₀	14 ^{-0.050} _{-0.093}	20 ^{+0.3} _{+0.1}	40	30	15	17	22	68	71	260	275
63	14 ^{+0.070} ₀	14 ^{-0.050} _{-0.093}	20 ^{+0.3} _{+0.1}	40	30	15	17	28	81	81	272	287
80	22 ^{+0.084} ₀	22 ^{-0.065} _{-0.117}	30 ^{+0.3} _{+0.1}	60	42	23	26	34	102	102	341	364
100	22 ^{+0.084} ₀	22 ^{-0.065} _{-0.117}	30 ^{+0.3} _{+0.1}	60	42	23	26	40	124	124	361	384

With Rubber Bumper [mm]

Bore size	Z	ZZ
32	219	229.5
40	237	248
50	268	283
63	280	295
80	351	374
100	371	394

Center trunnion: MWBT

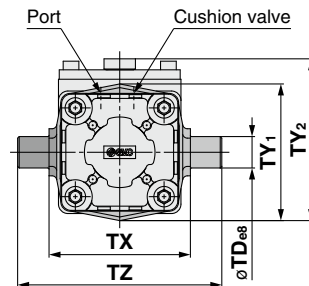
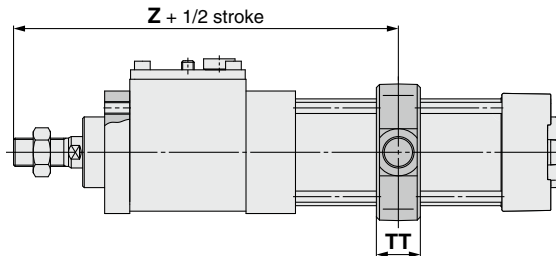

Bore size	TDø8	TT	TX	TY ₁	TY ₂	TZ	Z
32	12 ^{-0.032} _{-0.059}	17	50	49	71	74	148
40	16 ^{-0.032} _{-0.059}	22	63	58	77.5	95	166
50	16 ^{-0.032} _{-0.059}	22	75	71	91	107	183
63	20 ^{-0.040} _{-0.073}	28	90	87	103	130	195
80	20 ^{-0.040} _{-0.073}	34	110	110	126.5	150	242
100	25 ^{-0.040} _{-0.073}	40	132	136	148.5	182	262

With Rubber Bumper [mm]

Bore size	Z
32	151
40	169
50	187
63	199
80	247
100	267

MWB Series

Pivot Bracket: Trunnion and Double Clevis Pivot Bracket

Part No.

Bore size [mm]	32	40	50	63	80	100
Trunnion pivot bracket*1	MB-S03	MB-S04	MB-S04	MB-S06	MB-S06	MB-S10
Double clevis pivot bracket	MB-B03	MB-B03	MB-B05	MB-B05	MB-B08	MB-B08

*1 Order 2 trunnion pivot brackets per cylinder.

Trunnion pivot bracket

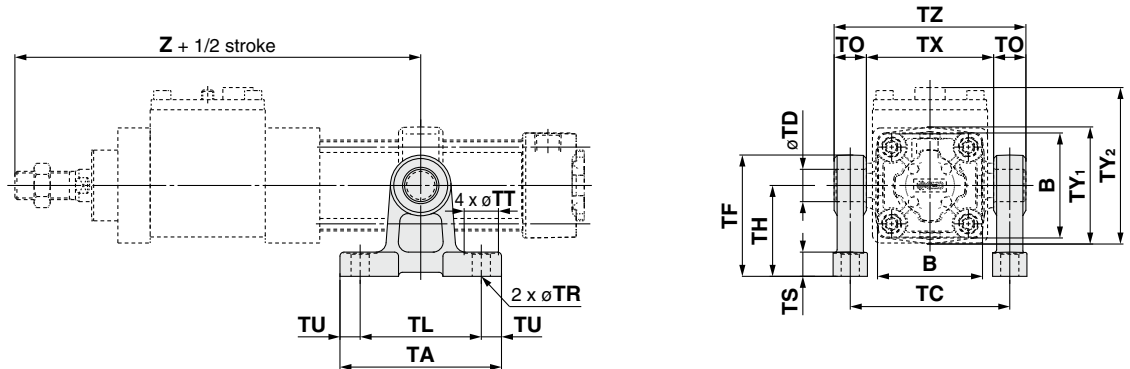

Part no.	Bore size	[mm]															With Rubber Bumper [mm]			
		B	TA	TL	TU	TC	TX	TZ	TO	TR	TT	TS	TH	TF	TY ₁	TY ₂	Z	TD _{H10}	Bore size	Z
MB-S03	32	46	62	45	8.5	62	50	74	12	7	13	10	35	47	49	71	148	12 ^{+0.070} ₀	32	151
	40	52	80	60	10	80	63	97	17	9	17	12	45	60	58	77.5	166	16 ^{+0.070} ₀		
MB-S04	50	65	80	60	10	92	75	109	17	9	17	12	45	60	71	91	183	16 ^{+0.070} ₀	50	187
	63	75	100	70	15	110	90	130	20	11	22	14	60	80	87	103	195	20 ^{+0.084} ₀		
MB-S06	80	95	100	70	15	130	110	150	20	11	22	14	60	80	110	126.5	242	20 ^{+0.084} ₀	80	247
	100	114	120	90	15	158	132	184	26	13.5	24	17	75	100	136	148.5	262	25 ^{+0.084} ₀		

Double clevis pivot bracket

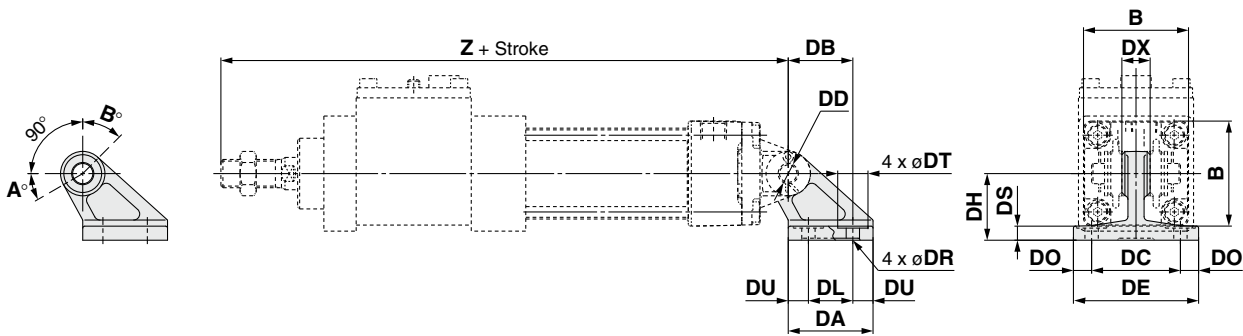

Part no.	Bore size	[mm]														With Rubber Bumper [mm]		
		B	DA	DB	DL	DU	DC	DX	DE	DO	DR	DT	DS	DH	Z	DD _{H10}	Bore size	Z
MB-B03	32	46	42	32	22	10	44	14	62	9	6.6	15	7	33	213	10 ^{+0.058} ₀	32	219
	40	52	42	32	22	10	44	14	62	9	6.6	15	7	33	231	10 ^{+0.058} ₀		
MB-B05	50	65	53	43	30	11.5	60	20	81	10.5	9	18	8	45	260	14 ^{+0.070} ₀	50	268
	63	75	53	43	30	11.5	60	20	81	10.5	9	18	8	45	272	14 ^{+0.070} ₀		
MB-B08	80	95	73	64	45	14	86	30	111	12.5	11	22	10	65	341	22 ^{+0.084} ₀	80	351
	100	114	73	64	45	14	86	30	111	12.5	11	22	10	65	361	22 ^{+0.084} ₀		

Rotating Angle

Bore size [mm]	A°	B°	A° + B° + 90°
32, 40	25°	45°	160°
50, 63	40°	60°	190°
80, 100	30°	55°	175°

Dimensions of Accessories

Rod end nut
(Standard)

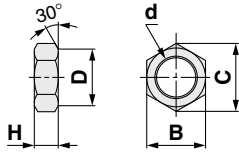

Part no.	Bore size	d	H	B	C	D
NT-03	32	M10 x 1.25	6	17	19.6	16.5
NT-04	40	M14 x 1.5	8	22	25.4	21
NT-05	50, 63	M18 x 1.5	11	27	31.2	26
NT-08	80	M22 x 1.5	13	32	37	31
NT-10	100	M26 x 1.5	16	41	47.3	39

I type
Single knuckle joint

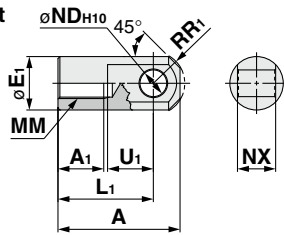

Part no.	Bore size	A	A ₁	E ₁	L ₁	MM	R ₁	U ₁	NDH ₁₀	NX
I-03M	32	40	14	20	30	M10 x 1.25	12	16	10 ^{+0.058} ₀	14 ^{-0.10} _{-0.30}
I-04M	40	50	19	22	40	M14 x 1.5	12.5	19	10 ^{+0.058} ₀	14 ^{-0.10} _{-0.30}
I-05M	50, 63	64	24	28	50	M18 x 1.5	16.5	24	14 ^{+0.070} ₀	20 ^{-0.10} _{-0.30}
I-08M	80	80	26	40	60	M22 x 1.5	23.5	34	22 ^{+0.084} ₀	30 ^{-0.10} _{-0.30}
I-10M	100	80	26	40	60	M26 x 1.5	23.5	34	22 ^{+0.084} ₀	30 ^{-0.10} _{-0.30}

Knuckle joint pin
Clevis pin

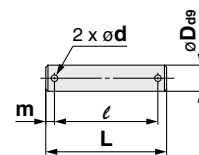

Part no.	Bore size	D _{d9}	L	l	m	d	Applicable split pin
CD-M03*1	32, 40	10 ^{-0.040} _{-0.076}	44	36	4	3	ø3 x 18L
CD-M05*1	50, 63	14 ^{-0.050} _{-0.093}	60	51	4.5	4	ø4 x 25L
CD-M08*1	80, 100	22 ^{-0.065} _{-0.117}	82	72	5	4	ø4 x 35L

*1 Split pins and flat washers are included.

Y type
Double knuckle joint

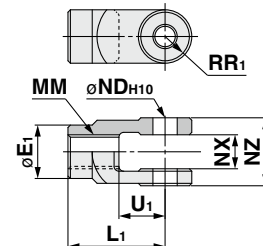

Part no.	Bore size	E ₁	L ₁	MM	R ₁	U ₁	NDH ₁₀	NX	NZ
Y-03M*1	32	20	30	M10 x 1.25	10	16	10 ^{+0.058} ₀	14 ^{+0.30} _{+0.10}	28 ^{-0.10} _{-0.30}
Y-04M*1	40	22	40	M14 x 1.5	11	19	10 ^{+0.058} ₀	14 ^{+0.30} _{+0.10}	28 ^{-0.10} _{-0.30}
Y-05M*1	50, 63	28	50	M18 x 1.5	14	24	14 ^{+0.070} ₀	20 ^{+0.30} _{+0.10}	40 ^{-0.10} _{-0.30}
Y-08M*1	80	40	65	M22 x 1.5	20	34	22 ^{+0.084} ₀	30 ^{+0.30} _{+0.10}	60 ^{-0.10} _{-0.30}
Y-10M*1	100	40	65	M26 x 1.5	20	34	22 ^{+0.084} ₀	30 ^{+0.30} _{+0.10}	60 ^{-0.10} _{-0.30}

*1 A pin, split pins and flat washers are included.

Bracket Combinations

Bracket combination available Refer to the figure below.

Bracket for workpiece	Single clevis	Double clevis	Single knuckle joint	Double knuckle joint	Clevis pivot bracket
Single clevis	—	1	—	2	—
Double clevis	3	—	4	—	9
Single knuckle joint	—	5	—	6	—
Double knuckle joint	7	—	8	—	10

No.	Appearance	No.	Appearance
1	Single clevis + Double clevis	6	Single knuckle joint + Double knuckle joint
2	Single clevis + Double knuckle joint	7	Double knuckle joint + Single clevis
3	Double clevis + Single clevis	8	Double knuckle joint + Single knuckle joint
4	Double clevis + Single knuckle joint	9	Double clevis + Clevis pivot bracket
5	Single knuckle joint + Double clevis	10	Double knuckle joint + Clevis pivot bracket

Cylinder with Lock

Double Acting, Double Rod

MWBW Series

∅32, ∅40, ∅50, ∅63, ∅80, ∅100



How to Order

MWBW B 40 - 50 - - - -

With auto switch MDWBW B 40 - 50 - - - - M9BW

With auto switch (Built-in magnet)

Double rod

Mounting

B	Basic
L	Axial foot
F	Rod flange
G	Head flange
T	Center trunnion

* Mounting brackets other than center trunnion type are shipped together.

Bore size

32	32 mm
40	40 mm
50	50 mm
63	63 mm
80	80 mm
100	100 mm

Port thread type

Nil	Rc
TN	NPT
TF	G

Cylinder stroke [mm]

Refer to page 18 for standard strokes.

Pivot bracket

Nil	No bracket
N	Pivot bracket

* Only for T mounting type.
* Pivot bracket is shipped together with the product.

Suffix (Cushion)

Nil	Air cushion
N*1	Rubber bumper

*1 Since the bumpers are attached to the both sides of the piston for rubber bumper type, the overall length is longer than the cylinder with air cushion as follows: ∅32, ∅40: +6 mm, ∅50, ∅63: +8 mm, ∅80, ∅100: +10 mm.

Suffix (Rod boot)

Nil	None
J	Nylon tarpaulin (Lock unit side)
JJ	Nylon tarpaulin (Both sides)
K	Heat-resistant tarpaulin (Lock unit side)
KK	Heat-resistant tarpaulin (Both sides)

Auto switch

Nil	Without auto switch
------------	---------------------

* For applicable auto switches, refer to the table below.

Number of auto switches

Nil	2
S	1
3	3
n	n

Rod end bracket

Nil	No bracket
V	Single knuckle joint
W	Double knuckle joint

* Only one rod end bracket is attached.
* A knuckle joint pin is not provided with the single knuckle joint.
* Rod end bracket is shipped together with the product.

Applicable Auto Switches/Refer to the Web Catalog for further information on auto switches.

Type	Special function	Electrical entry	Indicator light	Wiring (Output)	Load voltage		Auto switch model		Lead wire length [m]				Pre-wired connector	Applicable load		
					DC	AC	Tie-rod mounting	Band mounting	0.5 (Nil)	1 (M)	3 (L)	5 (Z)		IC circuit	Relay, PLC	
Solid state auto switch	—	Grommet	Yes	3-wire (NPN)	24 V	5 V, 12 V	—	M9N	●	●	●	○	○			—
				3-wire (PNP)				M9P	●	●	●	○	○			
		2-wire		M9B	●	●	●	○	○	—	—					
		3-wire (NPN)		Terminal conduit	24 V	5 V, 12 V	—	G39	—			—	—	—	—	—
	2-wire	K39	—					—	—	—	—	—				
	Diagnostic indication (2-color indicator)	Grommet	Yes	3-wire (NPN)	24 V	5 V, 12 V	—	M9NW	●	●			●	○	○	—
				3-wire (PNP)				M9PW	●	●	●	○	○			
				2-wire				M9BW	●	●	●	○	○	—	—	
				3-wire (NPN)				M9NA*1	—	○	○	●	○			○
				3-wire (PNP)				M9PA*1	—	○	○	●	○	○	—	—
2-wire				M9BA*1				—	○	○	●	○	○	—		
4-wire (NPN)	F59F	—	●	—	●	○	○	—	—							
2-wire (Non-polar)	P3DWA	—	●	—	●	●	○			—	—					
With diagnostic output (2-color indicator)	Terminal conduit	Yes	3-wire (NPN equivalent)	24 V	5 V	—	A96	●	—			●	—	—	—	—
Magnetic field-resistant (2-color indicator)							DIN terminal	Yes	2-wire	24 V	12 V	—	A93	●		
	100 V	A90	—	●	—	●							—	—	—	
	100 V or less	A54	—	●	—	●							●			—
	100 V, 200 V	A64	—	●	—	●							—	—	—	
	200 V or less	A33	—	—	—	—							—			—
	—	A34	—	—	—	—							—	—	—	
100 V, 200 V	A44	—	—	—	—	—	—	—								
Diagnostic indication (2-color indicator)	Grommet	Yes	3-wire (NPN equivalent)	24 V	—	—			A59W	●	—	●	—	—	—	—

*1 Water-resistant type auto switches can be mounted on the above models, but SMC cannot guarantee water resistance. Please contact SMC regarding water-resistant types with the above model numbers.

* Lead wire length symbols: 0.5 m.....Nil (Example) M9NW 3 m.....L (Example) M9NWL
1 m.....M (Example) M9NWM 5 m.....Z (Example) M9NWM

* Solid state auto switches marked with "○" are produced upon receipt of order.

* Since there are applicable auto switches other than those listed above, refer to page 30 for details.

* The D-A9□/M9□/P3DWA□ auto switches are shipped together, but not assembled. (Only the auto switch mounting brackets are assembled for the D-A9□/M9□ before shipment.)

Cylinder with Lock Double Acting, Double Rod **MWBW Series**



Made to Order Individual Specifications (For details, refer to page 35.)

Symbol	Specifications
-X3000	Dimensionally compatible with the MNB series
-X3030□	With lock status indication

Made to Order Common Specifications [Click here for details](#)

Symbol	Specifications
-XC35	With coil scraper

For details of **cylinders with auto switches**
⇨ pages 24 to 30

- Auto Switch Proper Mounting Position (Detection at stroke end) and Mounting Height
- Minimum Stroke for Auto Switch Mounting
- Auto Switch Mounting Brackets/Part Nos.
- Operating Range

Cylinder Specifications

Bore size [mm]	32	40	50	63	80	100
Action	Double acting, Double rod					
Fluid	Air					
Proof pressure	1.5 MPa					
Max. operating pressure	1.0 MPa					
Min. operating pressure	0.08 MPa					
Ambient and fluid temperatures	Without auto switch: -10°C to 70°C With auto switch: -10°C to 60°C (No freezing)					
Lubricant	Not required (Non-lube)					
Piston speed	50 to 1000 mm/s*1					
Stroke length tolerance	Up to 250 st: ${}^{+1.0}_0$, 251 to 1000 st: ${}^{+1.4}_0$, 1001 to 1500 st: ${}^{+1.8}_0$					
Cushion	Air cushion or Rubber bumper					
Port size (Rc, NPT, G)	1/8	1/4	3/8	1/2		
Mounting	Basic, Axial foot, Rod flange, Head flange, Center trunnion					

- *1 Load limits exist depending upon the piston speed when locked, mounting direction, and operating pressure.
* Kinetic energy absorbable by the cushion mechanism is identical to that of the double acting, single rod type.

Lock Unit Specifications

Bore size [mm]	32	40	50	63	80	100
Locking action	Exhaust locking					
Max. operating pressure	1.0 MPa					
Min. operating pressure	0.3 MPa					
Locking direction	Both directions					
Holding force (Max. static load) [N]*1	630	980	1570	2450	3920	6080

- *1 The holding force (max. static load) shows the maximum capability and does not show the normal holding capability. Be sure to select a cylinder using the method described in Model Selection (page 5).

Standard Strokes

- * When using with auto switches, refer to the Minimum Stroke for Auto Switch Mounting table on pages 26 to 28.

Bore size	Standard stroke		Max. manufacturable stroke
	Stroke range ①	Stroke range ②	
32	25, 50, 75, 100, 125, 150, 175, 200, 250, 300, 350, 400, 450, 500	Up to 1000	Up to 1800
40	25, 50, 75, 100, 125, 150, 175, 200, 250, 300, 350, 400, 450, 500		
50	25, 50, 75, 100, 125, 150, 175, 200, 250, 300, 350, 400, 450, 500, 600	Up to 1200	
63	25, 50, 75, 100, 125, 150, 175, 200, 250, 300, 350, 400, 450, 500, 600		
80	25, 50, 75, 100, 125, 150, 175, 200, 250, 300, 350, 400, 450, 500, 600, 700, 800	Up to 1500	
100	25, 50, 75, 100, 125, 150, 175, 200, 250, 300, 350, 400, 450, 500, 600, 700, 800		

- * The manufacturing of intermediate strokes is possible. (Spacers are not used.)
* Applicable strokes should be confirmed according to the usage. For details, refer to the Air Cylinders Model Selection in the **Web Catalog**. In addition, products that exceed the stroke range ① might not be able to fulfill the specifications due to deflection, etc.
* Please consult with SMC for details on manufacturability and for part numbers when exceeding the stroke range ②.
* When using a rod boot, a stroke range of up to 1000 mm is available. Please consult with SMC when exceeding a 1000 mm stroke.

Stopping Accuracy

Bore size [mm]	32	40	50	63	80	100
Lock type	Exhaust locking					
Stopping accuracy [mm]	±1.0					
Conditions	<ul style="list-style-type: none"> · Mounting orientation: Horizontal · Supply pressure: 0.5 MPa · Piston speed: 300 mm/s · Load condition: Upper limit of allowed value Solenoid valve for locking is mounted on the unlock port. Maximum value of stopping position dispersion from 100 measurements					

MWBW Series

Accessories

Mounting		Basic	Axial foot	Rod flange	Head flange	Center trunnion
Standard	Rod end nut	●	●	●	●	●
Option	Single knuckle joint	●	●	●	●	●
	Double knuckle joint (with pin)	●	●	●	●	●
	Rod boot	●	●	●	●	●

* Refer to page 16 for dimensions and part numbers of the accessories. (Except rod boot)

Mounting Brackets/Part Nos.

Bore size [mm]	32	40	50	63	80	100
Axial foot*1	MB-L03	MB-L04	MB-L05	MNB-L06*	MB-L08	MB-L10
Rod/Head flange	MNB-F03*	MNB-F04*	MNB-F05*	MNB-F06*	MB-F08	MB-F10

*1 Order two foot brackets per cylinder.

* Accessories for each mounting bracket are as follows.

Axial foot, Rod/Head flange: Body mounting bolt

* All are common to the MB series air cylinders, except the sections marked with a “*”.

Theoretical Output

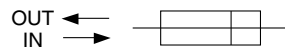

(Unit: N)

Bore size [mm]	Rod size [mm]	Operating direction	Piston area [mm ²]	Operating pressure [MPa]									
				0.2	0.3	0.4	0.5	0.6	0.7	0.8	0.9	1.0	
32	12	IN/OUT	691	138	207	276	346	415	484	553	622	691	
40	16	IN/OUT	1056	211	317	422	528	634	739	845	950	1056	
50	20	IN/OUT	1649	330	495	660	825	989	1154	1319	1484	1649	
63	20	IN/OUT	2803	561	841	1121	1402	1682	1962	2242	2523	2803	
80	25	IN/OUT	4536	907	1361	1814	2268	2722	3175	3629	4082	4536	
100	30	IN/OUT	7147	1429	2144	2859	3574	4288	5003	5718	6432	7147	

* Theoretical output [N] = Pressure [MPa] x Piston area [mm²]

Weight

[kg]

Bore size [mm]		32	40	50	63	80	100
Basic weight (at 0 stroke)	Basic						
	Lock unit	0.42	0.83	1.15	1.79	2.81	5.44
	Cylinder (at 0 stroke)	0.51	0.86	1.44	1.79	3.97	5.09
	Total	0.93	1.69	2.59	3.58	6.78	10.53
Mounting bracket weight (including bracket mounting bolts)	Foot bracket (2 pcs.)	0.12	0.14	0.22	0.26	0.50	0.66
	Rod/Head flange	0.24	0.32	0.53	0.74	1.45	1.83
	Trunnion bracket	0.29	0.36	0.48	0.80	1.55	1.69
Additional weight per 50 mm of stroke		0.15	0.24	0.37	0.38	0.61	0.82
Accessories	Single knuckle joint	0.15	0.23	0.26	0.26	0.60	0.83
	Double knuckle joint (with pin)	0.22	0.37	0.43	0.43	0.87	1.27

Rod Boot Material

Symbol	Material	Max. ambient temp.
J	Nylon tarpaulin	70°C
K	Heat-resistant tarpaulin	110°C*1

*1 Max. ambient temperature for rod boot itself

Calculation example)

MWBWL32-100 (Axial foot, ø32, 100 mm stroke)

● Basic weight...0.42 (Lock unit, ø32)

● Basic weight...0.51 (Cylinder, ø32)

● Additional weight...0.15/50 mm stroke

● Cylinder stroke...100 mm stroke

● Foot bracket...0.12

$$0.42 + 0.51 + (0.15/50) \times 100 + 0.12 = 1.35 \text{ kg}$$

Construction

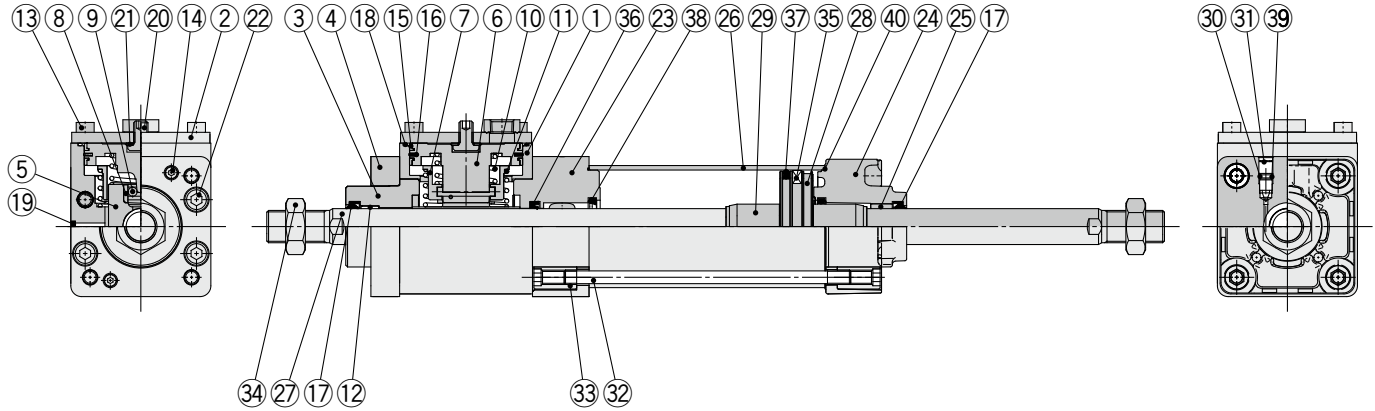

Component Parts

No.	Description	Material	Qty.	Note
1	Brake unit	Aluminum alloy	1	Hard anodized
2	Cap	Rolled steel	1	Zinc chromated
3	Collar	Aluminum alloy	1	Chromated
4	Retaining plate	Aluminum alloy	1	Anodized
5	Brake pad	Cast iron	1	
6	Piston A	Aluminum alloy	1	
7	Roller holder	Carbon steel	1	
8	Roller receiver	Stainless steel	2	Heat treated
9	Needle roller	Carbon steel	2	Heat treated
10	Piston spring	Spring steel	1	Zinc chromated
11	Roller spring	Spring steel	1	Zinc chromated
12	Bushing A	Bearing alloy	1	
13	Hexagon socket head cap screw	Alloy steel	4	
14	Hexagon socket head cap screw	Alloy steel	2	
15	Wear ring A	Resin	2	
16	Piston seal A	NBR	1	
17	Rod seal A	NBR	2	
18	Gasket	NBR	1	
19	Element	Bronze	1	
20	Release bolt	Alloy steel	1	
21	Seal washer	NBR + Stainless steel	1	
22	Hexagon socket head cap screw	Alloy steel	4	
23	Rod cover A	Aluminum alloy	1	Anodized
24	Rod cover B	Aluminum die-cast	1	Chromated
25	Bushing B	Bearing alloy	1	
26	Cylinder tube	Aluminum alloy	1	Hard anodized
27	Piston rod	Carbon steel	1	Hard chrome plating
28	Piston B	Aluminum alloy	1	

Component Parts

No.	Description	Material	Qty.	Note
29	Cushion ring	Aluminum alloy	2	Anodized
30	Cushion valve	Steel wire	2	Zinc chromated
31	Retaining ring	Spring steel	2	ø40 to ø100
32	Tie-rod	Carbon steel	4	Zinc chromated
33	Tie-rod nut	Carbon steel	8	Zinc chromated
34	Rod end nut	Carbon steel	2	Zinc chromated
35	Magnet	—	(1)	
36	Rod seal B	NBR	1	
37	Piston seal B	NBR	1	
38	Cushion seal	Urethane	2	
39	Cushion valve seal	NBR	2	
40	Cylinder tube gasket	NBR	2	

Replacement Parts/Seal Kit

Bore size [mm]	Kit no.	Contents
32	MWBW32-PS	A set of 17 Rod seal A, 36 Rod seal B, 37 Piston seal B, 38 Cushion seal, and 40 Cylinder tube gasket
40	MWBW40-PS	
50	MWBW50-PS	
63	MWBW63-PS	
80	MWBW80-PS	
100	MWBW100-PS	

* Never disassemble the lock unit. It should be replaced as a unit. Refer to page 42 for the part numbers for placing an order. The seal kit shown above contains the rod seal for the cylinder and lock unit. Order the seal kit suitable for the cylinder bore size.

* The seal kit shown above includes a grease pack.
(ø32, ø40, ø50: 10 g, ø63, ø80: 20 g, ø100: 30 g)
Order with the following part number when only the grease pack is needed.
Grease pack part number: GR-S-010 (10 g), GR-S-020 (20 g)

MWBW Series

Dimensions

Basic: MWBWB

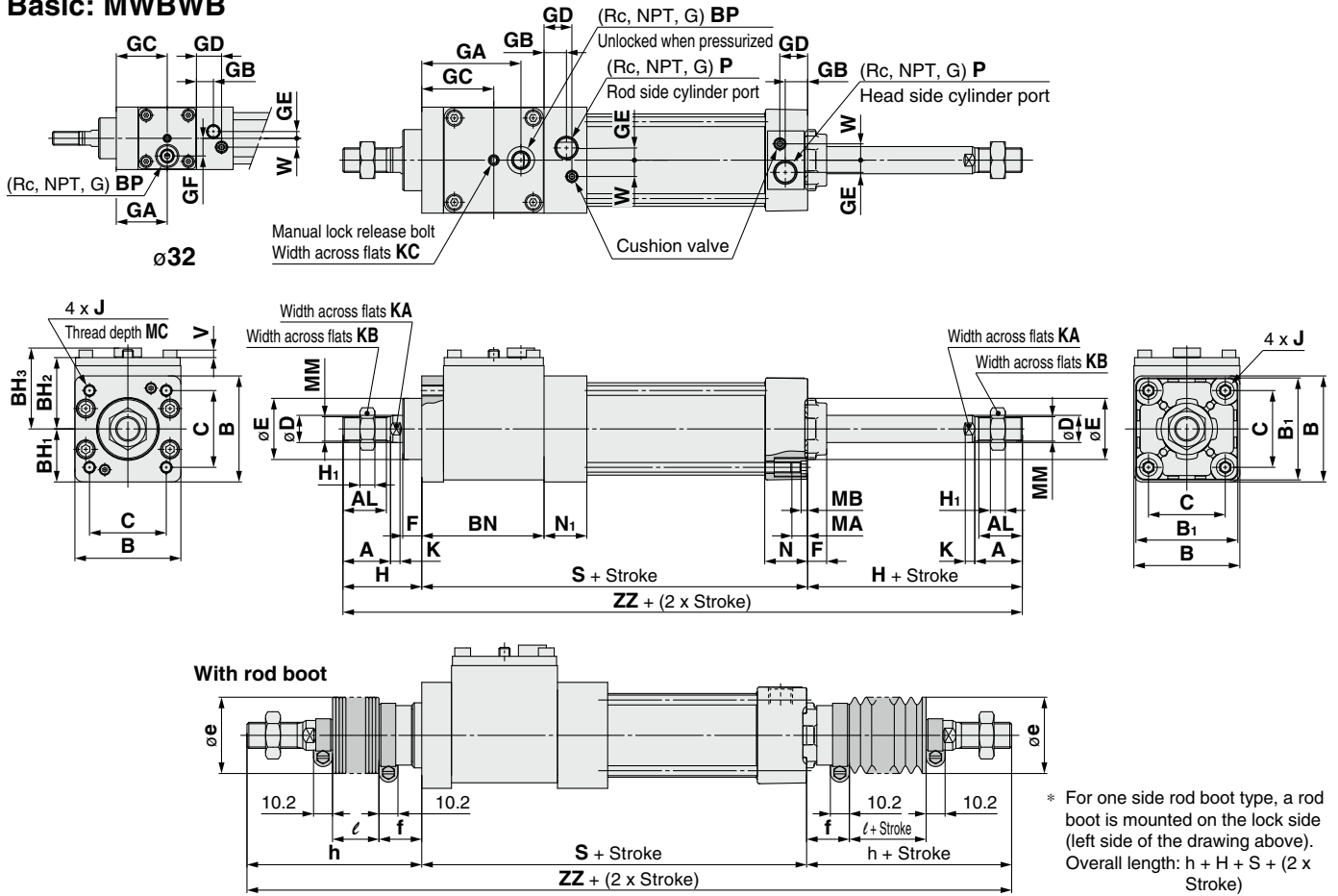

Bore size	A	AL	B	B ₁	BH ₁	BH ₂	BH ₃	BN	BP	C	D	E	F	GA	GB	GC	GD	GE	GF	H	H ₁	J
32	22	19.5	46	46	23	38.5	46.5	59	1/8	32.5	12	30	13	37.5	13	37.5	18.5	4	13	47	6	M6 x 1.0
40	30	27	57	52	28.5	42.5	48.5	73	1/8	38	16	35	13	59.5	14	44.5	19.5	4	—	51	8	M6 x 1.0
50	35	32	66	65	33	49	55.5	78	1/8	46.5	20	40	14	64	15.5	47	23	5	—	58	11	M8 x 1.25
63	35	32	78	75	39	52.5	59.5	90	1/4	56.5	20	45	14	73	16.5	53	20.5	9	—	58	11	M8 x 1.25
80	40	37	98	95	49	64.5	71.5	113	1/4	72	25	45	20	92	19	65	26	11.5	—	72	13	M10 x 1.5
100	40	37	116	114	58	73.5	80.5	131	1/4	89	30	55	20	109	19	74	26	17	—	72	16	M10 x 1.5

Bore size	K	KA	KB	KC	MA	MB	MC	MM	N	N ₁	P	S	V	W	ZZ	With Rubber Bumper		
																Bore size	With Rubber Bumper	
32	6	10	17	3	16	4	16	M10 x 1.25	27	27	1/8	143	3.5	6.5	237	32	149	243
40	6	14	22	3	16	4	16	M14 x 1.5	27	27	1/4	157	4.5	9	259	40	163	265
50	7	18	27	4	16	5	16	M18 x 1.5	31.5	31.5	1/4	172	4.5	10.5	288	50	180	296
63	7	18	27	4	16	5	16	M18 x 1.5	31.5	31.5	3/8	184	5.5	12	300	63	192	308
80	10	22	32	5	16	5	17	M22 x 1.5	38	38	3/8	227	7.5	14	371	80	237	381
100	10	26	41	5	16	5	17	M26 x 1.5	38	40	1/2	247	9.5	15	391	100	257	401

With Rod Boot

Bore size	d	e	f	ℓ												h											
				1 to 50	51 to 100	101 to 150	151 to 200	201 to 300	301 to 400	401 to 500	501 to 600	601 to 700	701 to 800	1 to 50	51 to 100	101 to 150	151 to 200	201 to 300	301 to 400	401 to 500	501 to 600	601 to 700	701 to 800				
32	54	36	23	12.5	25	37.5	50	75	100	125	—	—	—	73	86	98	111	136	161	186	—	—	—				
40	56	41	23	12.5	25	37.5	50	75	100	125	—	—	—	81	94	106	119	144	169	194	—	—	—				
50	64	51	25	12.5	25	37.5	50	75	100	125	150	—	—	89	102	114	127	152	177	202	227	—	—				
63	64	51	25	12.5	25	37.5	50	75	100	125	150	—	—	89	102	114	127	152	177	202	227	—	—				
80	68	56	29	12.5	25	37.5	50	75	100	125	150	175	200	101	114	126	139	164	189	214	239	264	289				
100	76	61	29	12.5	25	37.5	50	75	100	125	150	175	200	101	114	126	139	164	189	214	239	264	289				

Bore size	ZZ									
	1 to 50	51 to 100	101 to 150	151 to 200	201 to 300	301 to 400	401 to 500	501 to 600	601 to 700	701 to 800
32	289	315	339	365	415	465	515	—	—	—
40	319	345	369	395	445	495	545	—	—	—
50	350	376	400	426	476	526	576	626	—	—
63	362	388	412	438	488	538	588	638	—	—
80	429	455	479	505	555	605	655	705	755	805
100	449	475	499	525	575	625	675	725	775	825

Bore size	ZZ									
	1 to 50	51 to 100	101 to 150	151 to 200	201 to 300	301 to 400	401 to 500	501 to 600	601 to 700	701 to 800
32	295	321	345	371	421	471	521	—	—	—
40	325	351	375	401	451	501	551	—	—	—
50	358	384	408	434	484	534	584	634	—	—
63	370	396	420	446	496	546	596	646	—	—
80	439	465	489	515	565	615	665	715	765	815
100	459	485	509	535	585	635	685	735	785	835

* ZZ indicates dimensions for double side rod boot.

Dimensions: With Mounting Bracket

* Refer to Basic (B) for other dimensions.

Axial foot: MWBWL

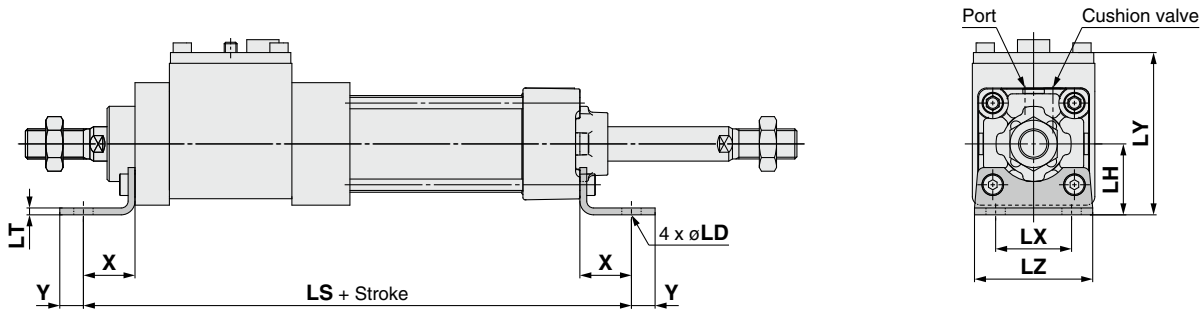

Bore size	LD	LH	LS	LT	LX	LY	LZ	X	Y
32	7	30	187	3.2	32	68.5	50	22	9
40	9	33	205	3.2	38	75.5	55	24	11
50	9	40	226	3.2	46	89	70	27	11
63	12	48	238	3.6	56	100.5	80	27	14
80	12	55	287	4.5	72	119.5	100	30	14
100	14	65	311	4.5	89	138.5	120	32	16

With Rubber Bumper [mm]	
Bore size	LS
32	193
40	211
50	234
63	246
80	297
100	321

Rod flange: MWBWF

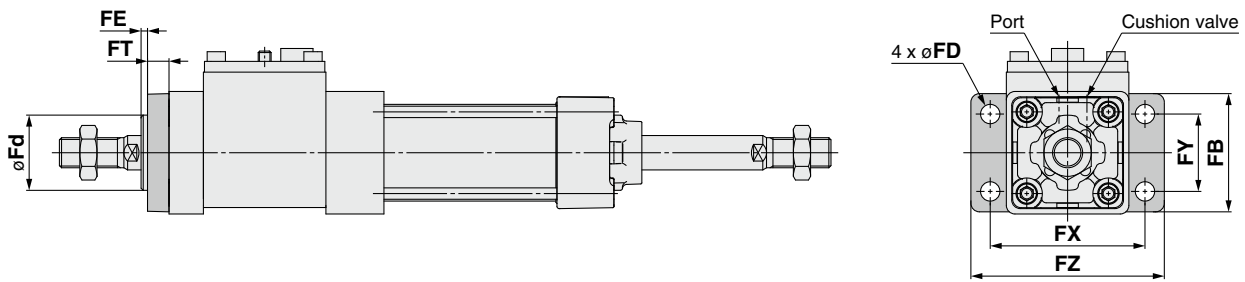

[mm]								
Bore size	FB	FD	Fd	FE	FT	FX	FY	FZ
32	56	7	30	3	10	72	38	87
40	65	9	35	3	10	83	46	101
50	77	9	40	2	12	100	52	120
63	92	9	45	2	12	115	62	135
80	100	12	45	4	16	126	63	153
100	120	14	55	4	16	150	75	178

Model Selection

Double Acting, Single Rod
MWB

Double Acting, Double Rod
MWBW

Lock Unit
MWB-UT

Auto Switch

Made to Order

MWBW Series

Dimensions: With Mounting Bracket

* Refer to Basic (B) for other dimensions.

Head flange: MWBWG

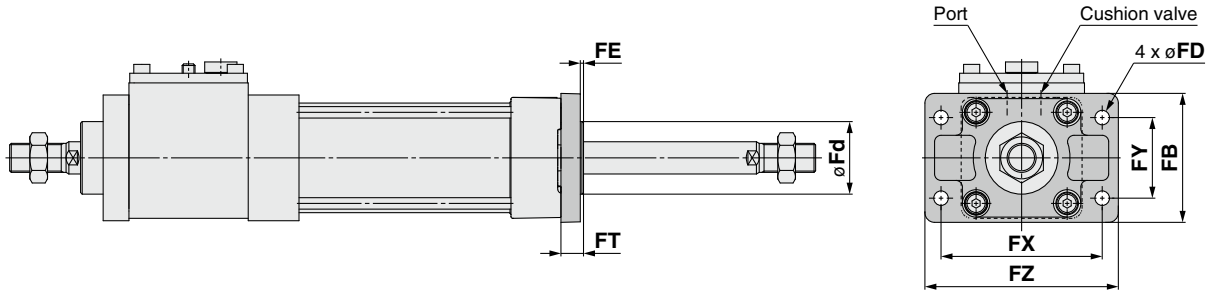

Bore size	FB	FD	Fd	FE	FT	FX	FY	FZ
32	56	7	24.5	3	10	72	38	87
40	65	9	29.5	3	10	83	46	101
50	77	9	35.5	2	12	100	52	120
63	92	9	38.5	2	12	115	62	135
80	100	12	41	4	16	126	63	153
100	120	14	46	4	16	150	75	178

Center trunnion: MWBWT

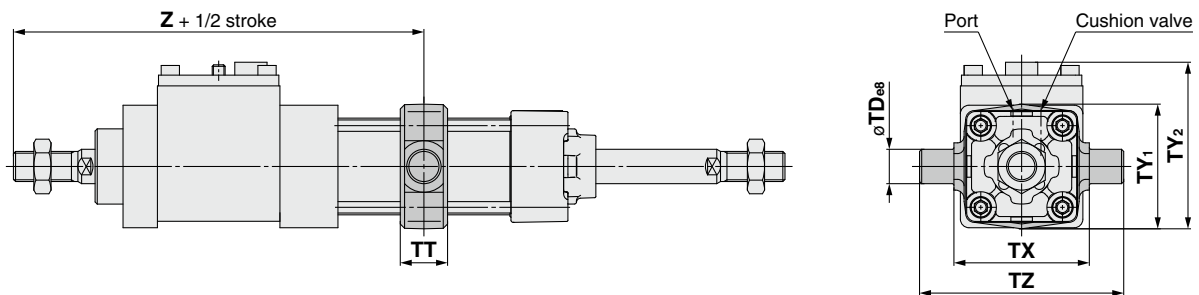

Bore size	TD _{ø8}	TT	TX	TY ₁	TY ₂	TZ	Z
32	12 ^{+0.032} _{-0.059}	17	50	49	71	74	148
40	16 ^{+0.032} _{-0.059}	22	63	58	77.5	95	166
50	16 ^{+0.032} _{-0.059}	22	75	71	91	107	183
63	20 ^{+0.040} _{-0.073}	28	90	87	103	130	195
80	20 ^{+0.040} _{-0.073}	34	110	110	126.5	150	242
100	25 ^{+0.040} _{-0.073}	40	132	136	148.5	182	262

With Rubber Bumper [mm]

Bore size	Z
32	151
40	169
50	187
63	199
80	247
100	267

MWB Series Auto Switch Mounting

Auto Switch Proper Mounting Position (Detection at stroke end) and Mounting Height

<Tie-rod mounting>

D-M9□/M9□V D-Y59□/Y69□/Y7P/Y7PV
 D-M9□W/M9□WV D-Y7□W/Y7□WV/Y7BA
 D-M9□A/M9□AV D-Z7□/Z80
 D-A9□/A9□V

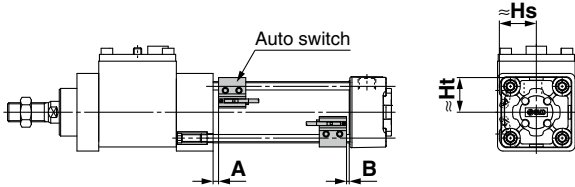

D-A5□/A6□
 D-A59W

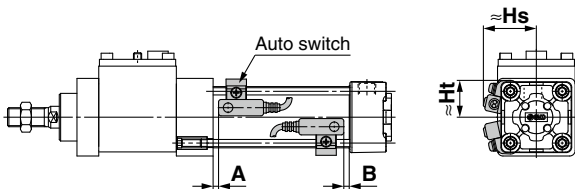

D-F5□/J5□
 D-F5□W/J59W/F5BA
 D-F59F/F5NT

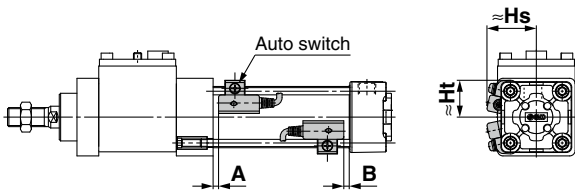

D-P3DWA

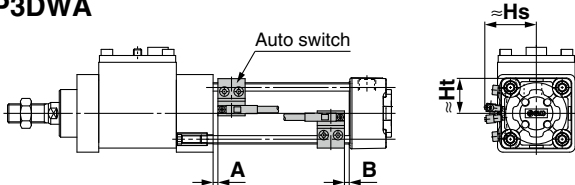

D-P4DW

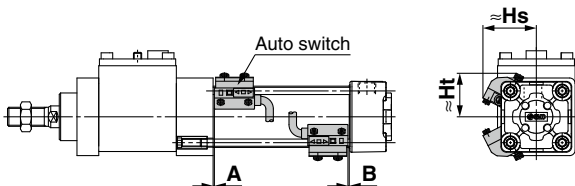

<Band mounting>

D-G39/K39/A3□

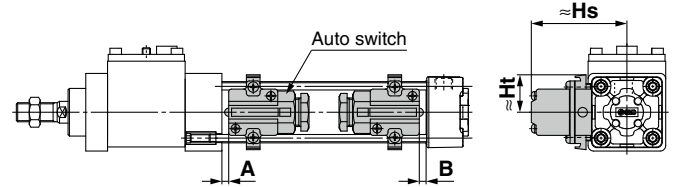

D-A44

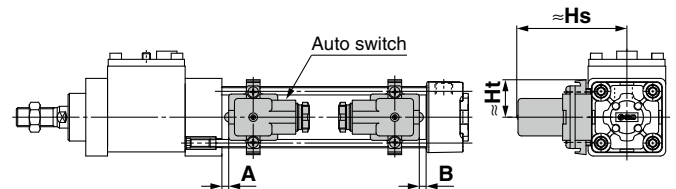

Model Selection

Double Acting, Single Rod

MWB

Double Acting, Double Rod

MWBW

Lock Unit

MWB-UT

Auto Switch

Made to Order

Auto Switch Proper Mounting Position (Detection at stroke end) and Mounting Height

Auto Switch Proper Mounting Position

[mm]

Auto switch model	D-M9□ D-M9□V D-M9□W D-M9□WV D-M9□A D-M9□AV		D-A9□ D-A9□V		D-F5□ D-J59 D-F59F		D-F5NT		D-A5□ D-A6□		D-A59W		D-G39 D-K39 D-A3□ D-A44		D-Y59□ D-Y69□ D-Y7P D-Y7PV D-Y7H D-Y7□W D-Y7□WV D-Z7□ D-Z8□		D-P3DWA		D-P4DW	
	A	B	A	B	A	B	A	B	A	B	A	B	A	B	A	B	A	B	A	B
32	10	8	6	4	6.5	4.5	11.5	9.5	0	0	4	2	0	0	3.5	1.5	5.5	3.5	3	1
40	9	9	5	5	5.5	5.5	10.5	10.5	0	0	3	3	0	0	2.5	2.5	4.5	4.5	2	2
50	10	9	6	5	6.5	5.5	11.5	10.5	0	0	4	3	0	0	3.5	2.5	5.5	4.5	3	2
63	10	9	6	5	6.5	5.5	11.5	10.5	0	0	4	3	0	0	3.5	2.5	5.5	4.5	3	2
80	14.5	11.5	10.5	7.5	11	8	16	13	4.5	1.5	8.5	5.5	4.5	1.5	8	5	10	7	7.5	4.5
100	14	12	10	8	10.5	8.5	15.5	13.5	4	2	8	6	4	2	7.5	5.5	9.5	7.5	7	5

* Models with rubber bumper have different dimensions for auto switch proper mounting positions (A and B). Add the following values to both A and B: 3 mm (ø32 and 40), 4 mm (ø50 and 63), 5 mm (ø80 and 100).

* Adjust the auto switch after confirming the operating conditions in the actual setting.

Auto Switch Mounting Height

[mm]

Auto switch model	D-M9□ D-M9□W D-M9□A D-A9□		D-A9□V		D-M9□V D-M9□WV D-M9□AV		D-F5□ D-J59 D-F59F D-F5□W D-J59W D-F5BA D-F5NT		D-A5□ D-A6□ D-A59W		D-G39 D-K39 D-A3□		D-A44		D-Y59□ D-Y7P D-Y7□W D-Y7BA D-Z7□ D-Z80		D-Y69□ D-Y7PV D-Y7□WV		D-P3DWA		D-P4DW	
	Hs	Ht	Hs	Ht	Hs	Ht	Hs	Ht	Hs	Ht	Hs	Ht	Hs	Ht	Hs	Ht	Hs	Ht	Hs	Ht	Hs	Ht
32	24.5	23	27.5	23	30.5	23	32.5	25	35	24.5	67	27.5	77	27.5	25.5	23	26.5	23	38	31	38	31
40	28.5	25.5	31.5	25.5	34	25.5	36.5	27.5	38.5	27.5	71.5	27.5	81.5	27.5	29.5	26	30	26	39	25.5	42	33
50	33.5	31	36	31	38.5	31	41	34	43.5	34.5	77	—	87	—	33.5	31	34.5	31	43	31	46.5	39
63	38.5	36	40.5	36	43	36	46	39	48.5	39.5	83.5	—	93.5	—	39	36	40	36	48	36	51.5	44
80	46.5	45	49	45	52	45	52.5	46.5	55	46.5	92.5	—	103	—	47.5	45	48.5	45	56.5	45	58	51.5
100	54	53.5	57	53.5	59.5	53.5	59.5	55	62	55	103	—	113.5	—	55.5	53.5	56.5	53.5	64.5	53.5	65.5	60.5

Minimum Stroke for Auto Switch Mounting

Mounting Brackets except Center Trunnion

n: Number of auto switches [mm]

Auto switch model	Number of auto switches	ø32, ø40, ø50, ø63	ø80, ø100
D-M9□ D-M9□W	2 (Different surfaces, same surface)	15	
	1	15	
D-M9□V D-M9□WV	2 (Different surfaces, same surface)	10	
	1	10	
D-M9□A	2 (Different surfaces, same surface)	15	
	1	15	
D-M9□AV	2 (Different surfaces, same surface)	15	
	1	15	
D-A9□	2 (Different surfaces, same surface)	15	
	1	15	
D-A9□V	2 (Different surfaces, same surface)	10	
	1	10	
D-G39 D-K39 D-A3□	2 (Different surfaces)	35	
	2 (Same surface)	100	
	n (Different surfaces)	35 + 30 (n - 2) (n = 2, 3, 4...)	
	n (Same surface)	100 + 100 (n - 2) (n = 2, 3, 4...)	
	1	10	
D-A44	2 (Different surfaces)	35	
	2 (Same surface)	55	
	n (Different surfaces)	35 + 30 (n - 2) (n = 2, 3, 4...)	
	n (Same surface)	55 + 50 (n - 2) (n = 2, 3, 4...)	
	1	10	
D-F5□ D-J59 D-F5□W D-J59W D-F5BA D-F59F	2 (Different surfaces, same surface)	15	25
	n (Same surface)	15 + 55 $\frac{(n-2)}{2}$ (n = 2, 4, 6, 8...)*1	25 + 55 $\frac{(n-2)}{2}$ (n = 2, 4, 6, 8...)*1
	1	10	25
D-A5□ D-A6□	2 (Different surfaces, same surface)	15	20
	1	15	20
D-A59W	2 (Different surfaces, same surface)	20	25
	n (Same surface)	20 + 55 $\frac{(n-2)}{2}$ (n = 2, 4, 6, 8...)*1	25 + 55 $\frac{(n-2)}{2}$ (n = 2, 4, 6, 8...)*1
D-F5NT	2 (Different surfaces, same surface)	15	25
	n (Same surface)	15 + 55 $\frac{(n-2)}{2}$ (n = 2, 4, 6, 8...)*1	25 + 55 $\frac{(n-2)}{2}$ (n = 2, 4, 6, 8...)*1
	1	10	25
D-Y59□ D-Y7P D-Y7□W D-Z7□ D-Z80	2 (Different surfaces, same surface)	15	
	1	15	
	n	15 + 40 $\frac{(n-2)}{2}$ (n = 2, 4, 6, 8...)*1	

*1 When "n" is an odd number, an even number that is one larger than the odd number is to be used for the calculation.

Model Selection
 Double Acting, Single Rod **MWB**
 Double Acting, Double Rod **MWBW**
 Lock Unit **MWB-UT**
 Auto Switch
 Made to Order

Minimum Stroke for Auto Switch Mounting

Mounting Brackets except Center Trunnion

n: Number of auto switches [mm]

Auto switch model	Number of auto switches	$\phi 32, \phi 40, \phi 50, \phi 63, \phi 80, \phi 100$
D-Y69□ D-Y7PV D-Y7□WV	2 (Different surfaces, same surface) 1	10
	n	$10 + 30 \frac{(n-2)}{2}$ (n = 2, 4, 6, 8...)*1
D-Y7BA	2 (Different surfaces, same surface) 1	20
	n	$20 + 45 \frac{(n-2)}{2}$ (n = 2, 4, 6, 8...)*1
D-P3DWA	2 (Different surfaces, same surface) 1	15
	n	$15 + 50 \frac{(n-2)}{2}$ (n = 2, 4, 6, 8...)*1
D-P4DW	2 (Different surfaces, same surface) 1	15
	n	$15 + 65 \frac{(n-2)}{2}$ (n = 2, 4, 6, 8...)*1

*1 When "n" is an odd number, an even number that is one larger than the odd number is to be used for the calculation.

Center Trunnion

n: Number of auto switches [mm]

Auto switch model	Number of auto switches	$\phi 32$	$\phi 40$	$\phi 50$	$\phi 63$	$\phi 80$	$\phi 100$
D-M9□ D-M9□W	2 (Different surfaces, same surface) 1	75	80	85	90	95	
	n	$75 + 40 \frac{(n-4)}{2}$ (n = 4, 8, 12, 16...)*2	$80 + 40 \frac{(n-4)}{2}$ (n = 4, 8, 12, 16...)*2	$85 + 40 \frac{(n-4)}{2}$ (n = 4, 8, 12, 16...)*2	$90 + 40 \frac{(n-4)}{2}$ (n = 4, 8, 12, 16...)*2	$95 + 40 \frac{(n-4)}{2}$ (n = 4, 8, 12, 16...)*2	
D-M9□V D-M9□WV	2 (Different surfaces, same surface) 1	50	55	60	65	70	
	n	$50 + 30 \frac{(n-4)}{2}$ (n = 4, 8, 12, 16...)*2	$55 + 30 \frac{(n-4)}{2}$ (n = 4, 8, 12, 16...)*2	$60 + 30 \frac{(n-4)}{2}$ (n = 4, 8, 12, 16...)*2	$65 + 30 \frac{(n-4)}{2}$ (n = 4, 8, 12, 16...)*2	$70 + 30 \frac{(n-4)}{2}$ (n = 4, 8, 12, 16...)*2	
D-M9□A	2 (Different surfaces, same surface) 1	80	85	90	95	100	
	n	$80 + 40 \frac{(n-4)}{2}$ (n = 4, 8, 12, 16...)*2	$85 + 40 \frac{(n-4)}{2}$ (n = 4, 8, 12, 16...)*2	$90 + 40 \frac{(n-4)}{2}$ (n = 4, 8, 12, 16...)*2	$95 + 40 \frac{(n-4)}{2}$ (n = 4, 8, 12, 16...)*2	$100 + 40 \frac{(n-4)}{2}$ (n = 4, 8, 12, 16...)*2	
D-M9□AV	2 (Different surfaces, same surface) 1	55	60	65	70	75	
	n	$55 + 30 \frac{(n-4)}{2}$ (n = 4, 8, 12, 16...)*2	$60 + 30 \frac{(n-4)}{2}$ (n = 4, 8, 12, 16...)*2	$65 + 30 \frac{(n-4)}{2}$ (n = 4, 8, 12, 16...)*2	$70 + 30 \frac{(n-4)}{2}$ (n = 4, 8, 12, 16...)*2	$75 + 30 \frac{(n-4)}{2}$ (n = 4, 8, 12, 16...)*2	
D-A9□	2 (Different surfaces, same surface) 1	70	75	80	85	90	
	n	$70 + 40 \frac{(n-4)}{2}$ (n = 4, 8, 12, 16...)*2	$75 + 40 \frac{(n-4)}{2}$ (n = 4, 8, 12, 16...)*2	$80 + 40 \frac{(n-4)}{2}$ (n = 4, 8, 12, 16...)*2	$85 + 40 \frac{(n-4)}{2}$ (n = 4, 8, 12, 16...)*2	$90 + 40 \frac{(n-4)}{2}$ (n = 4, 8, 12, 16...)*2	
D-A9□V	2 (Different surfaces, same surface) 1	45	50	55	60	70	
	n	$45 + 30 \frac{(n-4)}{2}$ (n = 4, 8, 12, 16...)*2	$50 + 30 \frac{(n-4)}{2}$ (n = 4, 8, 12, 16...)*2	$55 + 30 \frac{(n-4)}{2}$ (n = 4, 8, 12, 16...)*2	$60 + 30 \frac{(n-4)}{2}$ (n = 4, 8, 12, 16...)*2	$70 + 30 \frac{(n-4)}{2}$ (n = 4, 8, 12, 16...)*2	

*2 When "n" is an odd number, a multiple of 4 that is larger than the odd number is to be used for the calculation.

Minimum Stroke for Auto Switch Mounting

Center Trunnion

n: Number of auto switches [mm]

Auto switch model	Number of auto switches	ø32	ø40	ø50	ø63	ø80	ø100
D-G39 D-K39 D-A3 □	2 (Different surfaces)	60	65	75	80	85	
	2 (Same surface)	90	95	100	105	110	
	n (Different surfaces)	$60 + 30(n-2)$ (n = 2, 4, 6, 8...)*1	$65 + 30(n-2)$ (n = 2, 4, 6, 8...)*1	$75 + 30(n-2)$ (n = 2, 4, 6, 8...)*1	$80 + 30(n-2)$ (n = 2, 4, 6, 8...)*1	$85 + 30(n-2)$ (n = 2, 4, 6, 8...)*1	
	n (Same surface)	$90 + 100(n-2)$ (n = 2, 4, 6, 8...)*1	$95 + 100(n-2)$ (n = 2, 4, 6, 8...)*1	$100 + 100(n-2)$ (n = 2, 4, 6, 8...)*1	$105 + 100(n-2)$ (n = 2, 4, 6, 8...)*1	$110 + 100(n-2)$ (n = 2, 4, 6, 8...)*1	
	1	60	65	75	80	85	
D-A44	2 (Different surfaces)	70	75	80	85		
	2 (Same surface)						
	n (Different surfaces)	$70 + 30(n-2)$ (n = 2, 4, 6, 8...)*1	$75 + 30(n-2)$ (n = 2, 4, 6, 8...)*1	$80 + 30(n-2)$ (n = 2, 4, 6, 8...)*1	$85 + 30(n-2)$ (n = 2, 4, 6, 8...)*1		
	n (Same surface)	$70 + 50(n-2)$ (n = 2, 4, 6, 8...)*1	$75 + 50(n-2)$ (n = 2, 4, 6, 8...)*1	$80 + 50(n-2)$ (n = 2, 4, 6, 8...)*1	$85 + 50(n-2)$ (n = 2, 4, 6, 8...)*1		
	1	70	75	80	85		
D-F5 □/J59 D-F5 □W D-J59W D-F5BA D-F59F	2 (Different surfaces, same surface)	90	95	110	115	120	
	n (Same surface)	$90 + 55\frac{(n-4)}{2}$ (n = 4, 8, 12, 16...)*2	$95 + 55\frac{(n-4)}{2}$ (n = 4, 8, 12, 16...)*2	$110 + 55\frac{(n-4)}{2}$ (n = 4, 8, 12, 16...)*2	$115 + 55\frac{(n-4)}{2}$ (n = 4, 8, 12, 16...)*2	$120 + 55\frac{(n-4)}{2}$ (n = 4, 8, 12, 16...)*2	
	1	90	95	110	115	120	
D-F5NT	2 (Different surfaces, same surface)	100	105	120	125	130	
	n (Same surface)	$100 + 55\frac{(n-4)}{2}$ (n = 4, 8, 12, 16...)*2	$105 + 55\frac{(n-4)}{2}$ (n = 4, 8, 12, 16...)*2	$120 + 55\frac{(n-4)}{2}$ (n = 4, 8, 12, 16...)*2	$125 + 55\frac{(n-4)}{2}$ (n = 4, 8, 12, 16...)*2	$130 + 55\frac{(n-4)}{2}$ (n = 4, 8, 12, 16...)*2	
	1	100	105	120	125	130	
D-A5 □ D-A6 □	2 (Different surfaces, same surface)	60	80	105	110	115	
	1						
n (Same surface)	$60 + 55\frac{(n-4)}{2}$ (n = 4, 8, 12, 16...)*2	$80 + 55\frac{(n-4)}{2}$ (n = 4, 8, 12, 16...)*2	$105 + 55\frac{(n-4)}{2}$ (n = 4, 8, 12, 16...)*2	$110 + 55\frac{(n-4)}{2}$ (n = 4, 8, 12, 16...)*2	$115 + 55\frac{(n-4)}{2}$ (n = 4, 8, 12, 16...)*2		
D-A59W	2 (Different surfaces, same surface)	60	70	85	110	115	120
	n (Same surface)	$60 + 55\frac{(n-4)}{2}$ (n = 4, 8, 12, 16...)*2	$70 + 55\frac{(n-4)}{2}$ (n = 4, 8, 12, 16...)*2	$85 + 55\frac{(n-4)}{2}$ (n = 4, 8, 12, 16...)*2	$110 + 55\frac{(n-4)}{2}$ (n = 4, 8, 12, 16...)*2	$115 + 55\frac{(n-4)}{2}$ (n = 4, 8, 12, 16...)*2	$120 + 55\frac{(n-4)}{2}$ (n = 4, 8, 12, 16...)*2
	1	60	70	85	110	115	120
D-Y59 □ D-Y7P D-Y7 □W D-Z7 □ D-Z80	2 (Different surfaces, same surface)	80	85	90	95	100	
	1						
	n	$80 + 40\frac{(n-4)}{2}$ (n = 4, 8, 12, 16...)*2	$85 + 40\frac{(n-4)}{2}$ (n = 4, 8, 12, 16...)*2	$90 + 40\frac{(n-4)}{2}$ (n = 4, 8, 12, 16...)*2	$95 + 40\frac{(n-4)}{2}$ (n = 4, 8, 12, 16...)*2	$100 + 40\frac{(n-4)}{2}$ (n = 4, 8, 12, 16...)*2	
D-Y69 □ D-Y7PV D-Y7 □WV	2 (Different surfaces, same surface)	60	65	70	75	85	
	1						
n	$60 + 30\frac{(n-4)}{2}$ (n = 4, 8, 12, 16...)*2	$65 + 30\frac{(n-4)}{2}$ (n = 4, 8, 12, 16...)*2	$70 + 30\frac{(n-4)}{2}$ (n = 4, 8, 12, 16...)*2	$75 + 30\frac{(n-4)}{2}$ (n = 4, 8, 12, 16...)*2	$85 + 30\frac{(n-4)}{2}$ (n = 4, 8, 12, 16...)*2		
D-Y7BA	2 (Different surfaces, same surface)	85	90	100	105	110	
	1						
n	$85 + 45\frac{(n-4)}{2}$ (n = 4, 8, 12, 16...)*2	$90 + 45\frac{(n-4)}{2}$ (n = 4, 8, 12, 16...)*2	$100 + 45\frac{(n-4)}{2}$ (n = 4, 8, 12, 16...)*2	$105 + 45\frac{(n-4)}{2}$ (n = 4, 8, 12, 16...)*2	$110 + 45\frac{(n-4)}{2}$ (n = 4, 8, 12, 16...)*2		
D-P3DWA	2 (Different surfaces, same surface)	80	85	90	95		
	1						
n	$80 + 50\frac{(n-4)}{2}$ (n = 4, 8, 12, 16...)*2	$85 + 50\frac{(n-4)}{2}$ (n = 4, 8, 12, 16...)*2	$90 + 50\frac{(n-4)}{2}$ (n = 4, 8, 12, 16...)*2	$95 + 50\frac{(n-4)}{2}$ (n = 4, 8, 12, 16...)*2			
D-P4DW	2 (Different surfaces, same surface)	120	130	140			
	1						
n	$120 + 65\frac{(n-4)}{2}$ (n = 4, 8, 12, 16...)*2	$130 + 65\frac{(n-4)}{2}$ (n = 4, 8, 12, 16...)*2	$140 + 65\frac{(n-4)}{2}$ (n = 4, 8, 12, 16...)*2				

*1 When "n" is an odd number, an even number that is one larger than the odd number is to be used for the calculation.

*2 When "n" is an odd number, a multiple of 4 that is larger than the odd number is to be used for the calculation.

Model Selection

Double Acting, Single Rod
MWB

Double Acting, Double Rod
MWBW

Lock Unit
MWB-UT

Auto Switch

Made to Order

Auto Switch Mounting Brackets/Part Nos.

Auto switch model	Bore size [mm]					
	ø32	ø40	ø50	ø63	ø80	ø100
D-M9□/M9□V D-M9□W/M9□WV D-M9□A/M9□AV D-A9□/A9□V	BMB5-032	BMB5-032	BA7-040	BA7-040	BA7-063	BA7-063
D-A3□/A44 D-G39/K39	BMB2-032	BMB2-040	BMB1-050	BMB1-063	BMB1-080	BMB1-100
D-F5□/J59 D-F5□W/J59W D-F59F/F5BA D-F5NT D-A5□/A6□/A59W	BT-03	BT-03	BT-05	BT-05	BT-06	BT-06
D-P3DWA	BA10-032S	BA10-040S	BA10-050S	BA10-050S	BA10-063S	BA10-063S
D-P4DW	BMB3T-040	BMB3T-040	BMB3T-050	BMB3T-050	BMB3T-080	BMB3T-080
D-Y59□/Y69□ D-Y7P/Y7PV D-Y7□W/Y7□WV D-Y7BA D-Z7□/Z80	BMB4-032	BMB4-032	BMB4-050	BMB4-050	BA4-063	BA4-063

[Stainless Steel Mounting Screw]

The following stainless steel mounting screw kit (including set screws) is available. Use it in accordance with the operating environment. (Since the auto switch mounting bracket is not included, order it separately.)

BBA1: For D-A5/A6/F5/J5 types

* Refer to the **Web Catalog** for details on the BBA1.

The above stainless steel screws are used when a cylinder is shipped with the D-F5BA auto switch. When only one auto switch is shipped independently, the BBA1 is attached.

* When using the D-M9□A(V) or Y7BA, do not use the steel set screws which are included with the auto switch mounting brackets above (BMB5-032, BA7-□□□, BMB4-□□□, BA4-□□□).

Order a stainless steel screw kit (BBA1) separately, and use the M4 x 6 L stainless steel set screws included in the BBA1.

The figure shows the mounting example for the D-M9□(V)/M9□W(V)/M9□A(V)/A9□(V).

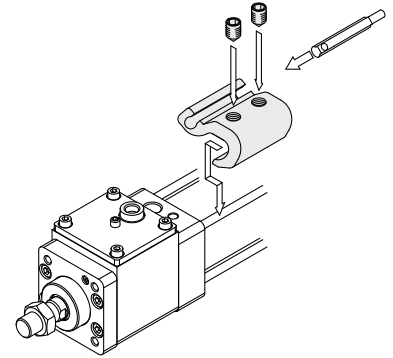

Operating Range

Auto switch model	Bore size [mm]					
	32	40	50	63	80	100
D-M9□/M9□V D-M9□W/M9□WV D-M9□A/M9□AV	4	4.5	4.5	4.5	5	6
D-Y59□/Y69□ D-Y7P/Y7□V D-Y7□W/Y7□WV D-Y7BA	5.5	5.5	7	7.5	6.5	5.5
D-F5□/J59 D-F5□W/J59W D-F5BA/F5NT D-F59F	3.5	4	4	4.5	4.5	4.5
D-G39/K39	9	9	9	10	10	11
D-P3DWA	3	4.5	4.5	5	5	5.5
D-P4DW	4	4	4	4.5	4	4.5
D-A9□/A9□V	7	7.5	8.5	9.5	9.5	10.5
D-Z7□/Z80	7.5	8.5	7.5	9.5	9.5	10.5
D-A5□/A6□	9	9	10	11	11	11
D-A59W	13	13	13	14	14	15
D-A3□/A44	9	9	10	11	11	11

* Values which include hysteresis are for reference purposes only. They are not a guarantee (assuming approximately ±30% dispersion) and may change substantially depending on the ambient environment.

<Mounting example for ø32, D-P3DWA>

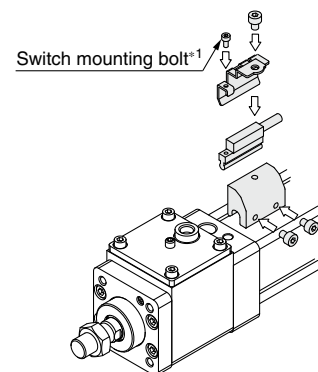

*1 The switch mounting bolt is supplied with the switch.

Other than the applicable auto switches listed in “How to Order,” the following auto switches are also mountable. Refer to the **Web Catalog** for the detailed specifications.

Type	Model	Electrical entry	Features
Solid state	D-M9NV/M9PV/M9BV	Grommet (Perpendicular)	—
	D-Y69A/Y69B/Y7PV		Diagnostic indication (2-color indicator)
	D-M9NWV/M9PWV/M9BWV		Water-resistant (2-color indicator)
	D-Y7NWV/Y7PWV/Y7BWV		Magnetic field-resistant (2-color indicator)
	D-M9NAV/M9PAV/M9BAV		—
	D-P3DW		Diagnostic indication (2-color indicator)
	D-P4DW	Grommet (In-line)	Water-resistant (2-color indicator)
	D-F59/F5P/J59		With timer
	D-Y59A/Y59B/Y7P		Magnetic field-resistant (2-color indicator)
	D-Y7H		—
	D-F59W/F5PW/J59W		Without indicator light
	D-Y7NW/Y7PW/Y7BW		—
	D-F5BA/Y7BA		Without indicator light
	D-F5NT		—
D-P5DW	Grommet (Perpendicular)	—	
D-A93V/A96V		Without indicator light	
D-A90V		—	
Reed	D-A53/A56/Z73/Z76	Grommet (In-line)	—
	D-A67/Z80		Without indicator light

* With pre-wired connector is also available for solid state switches. For details, refer to the **Web Catalog**.

* Normally closed (NC = b contact) solid state auto switches (D-M9□E(V)/Y7G/Y7H) are also available. For details, refer to the **Web Catalog**.

Model Selection

Double Acting, Single Rod
MWB

Double Acting, Double Rod
MWBW

Lock Unit
MWB-UT

Auto Switch

Made to Order

Prior to Use

Auto Switch Connections and Examples

Sink Input Specifications

3-wire, NPN

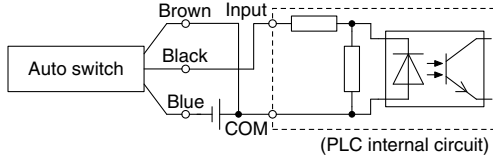

2-wire

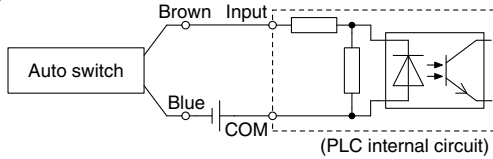

Source Input Specifications

3-wire, PNP

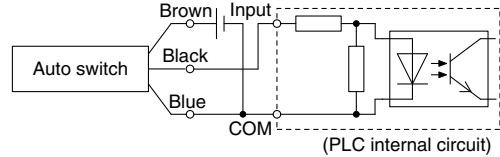

2-wire

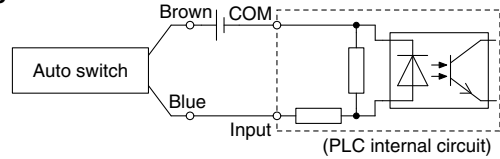

Connect according to the applicable PLC input specifications, as the connection method will vary depending on the PLC input specifications.

Examples of AND (Series) and OR (Parallel) Connections

* When using solid state auto switches, ensure the application is set up so the signals for the first 50 ms are invalid.

3-wire AND connection for NPN output (Using relays)

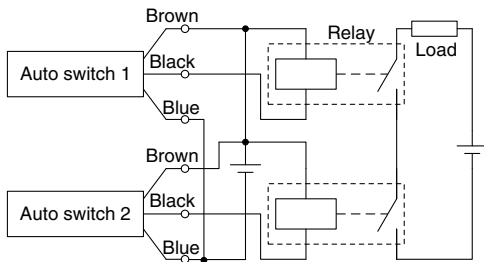

(Performed with auto switches only)

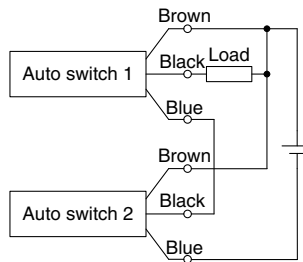

3-wire OR connection for NPN output

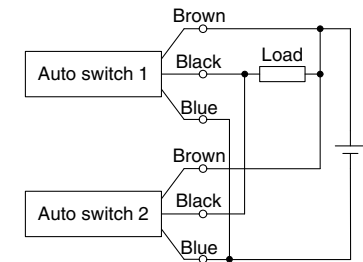

3-wire AND connection for PNP output (Using relays)

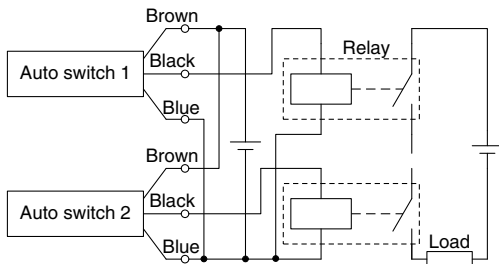

(Performed with auto switches only)

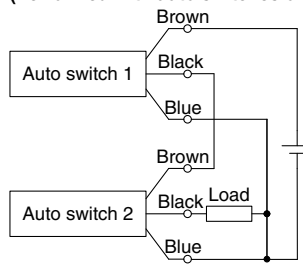

3-wire OR connection for PNP output

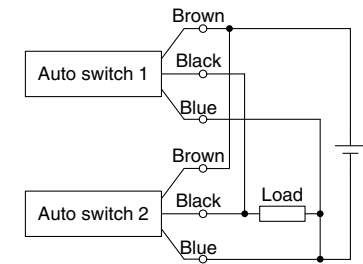

2-wire AND connection

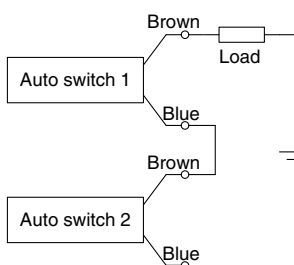

When two auto switches are connected in series, a load may malfunction because the load voltage will decline when in the ON state. The indicator lights will light up when both of the auto switches are in the ON state. Auto switches with a load voltage less than 20 V cannot be used.

$$\begin{aligned} \text{Load voltage at ON} &= \text{Power supply voltage} - \text{Residual voltage} \times 2 \text{ pcs.} \\ &= 24 \text{ V} - 4 \text{ V} \times 2 \text{ pcs.} \\ &= 16 \text{ V} \end{aligned}$$

Example: Power supply is 24 VDC
Internal voltage drop in auto switch is 4 V.

2-wire OR connection

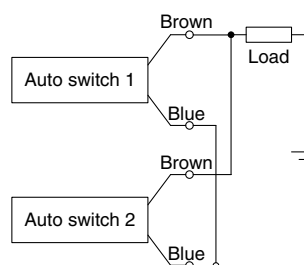

(Solid state)
When two auto switches are connected in parallel, malfunction may occur because the load voltage will increase when in the OFF state.

(Reed)
Because there is no current leakage, the load voltage will not increase when turned OFF. However, depending on the number of auto switches in the ON state, the indicator lights may sometimes grow dim or not light up, due to the dispersion and reduction of the current flowing to the auto switches.

$$\begin{aligned} \text{Load voltage at OFF} &= \text{Leakage current} \times 2 \text{ pcs.} \times \text{Load impedance} \\ &= 1 \text{ mA} \times 2 \text{ pcs.} \times 3 \text{ k}\Omega \\ &= 6 \text{ V} \end{aligned}$$

Example: Load impedance is 3 k Ω .
Leakage current from auto switch is 1 mA.

Lock Unit

MWB-UT Series

32, 40, 50, 63, 80, 100

RoHS

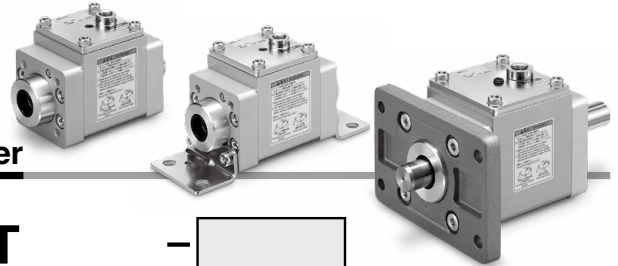

How to Order

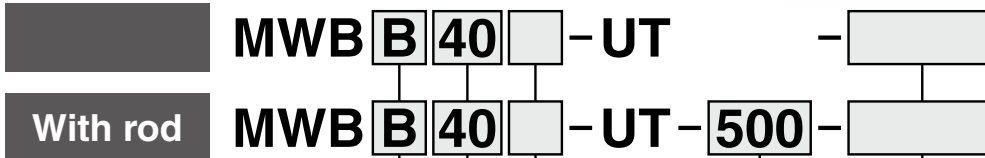

Mounting

B	Basic
L	Axial foot
F	Flange

* Mounting bracket is shipped together with the product.

Model

Model	Applicable rod size
32	12 mm
40	16 mm
50	20 mm
63	20 mm
80	25 mm
100	30 mm

Port thread type

Nil	Rc
TN	NPT
TF	G

• Made to order



Made to order individual specifications
(For details, refer to page 35-1.)

Symbol	Specifications
X3030 <input type="checkbox"/>	With lock status indication

[Click here for details](#)

XA <input type="checkbox"/>	Change of rod end shape
XC35	With coil scraper*1
XC68	Made of stainless steel

*1 Both sides are equipped with a coil scraper.

• Rod length [mm]

Nil		Without accessory rod	
Min. length	Max. length	Applicable model	Note
250	2500*1	32	Can be manufactured in increments of 1 mm up to the maximum length.
300		40	
		50	
		63	
		80	
		100	

*1 The maximum rod length of the MWB□32-XC68 is 1800 mm.

* The rod length indicates the overall length of the rod.

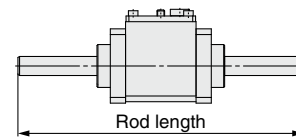

* Rod is shipped together with the product.

Specifications

Model	32	40	50	63	80	100
Applicable rod size [mm]*2	ø12 f8	ø16 f8	ø20 f8	ø20 f8	ø25 f8	ø30 f8
Locking action	Exhaust locking					
Proof pressure	1.5 MPa					
Max. operating pressure	1.0 MPa					
Min. operating pressure	0.3 MPa					
Locking direction	Both directions					
Holding force (Max. static load) [N]*1	630	980	1570	2450	3920	6080
Stopping accuracy [mm]	±1.0					

*1 The holding force (max. static load) shows the maximum capability and does not show the normal holding capability. Refer to pages 5 and 6 to select an appropriate lock unit.

*2 The applicable rod size affects the holding force, so use a rod with the rod size tolerance shown in the table above. For the shape of the rod end to be inserted, refer to page 44.

Weight

Bore size		32	40	50	63	80	100
Basic weight	Lock unit	0.59	1.09	1.51	2.32	4.41	7.00
Mounting bracket weight (including bracket mounting bolts)	Foot bracket (2 pcs.)	0.12	0.14	0.22	0.26	0.50	0.66
	Flange	0.24	0.32	0.53	0.74	1.45	1.83
Additional rod weight per 50 mm		0.04	0.08	0.12	0.12	0.19	0.27

Calculation example)

MWBL40-UT-500 (Axial foot, Model 40, With a 500 mm rod)

- Basic weight1.09 (Lock unit, Model 40)
- Additional weight0.08/50 mm
- Rod length500 mm
- Axial foot0.14

$$1.09 + (0.08/50) \times 500 + 0.14 = 2.03 \text{ kg}$$

Model Selection

Double Acting, Single Rod
MWB

Double Acting, Double Rod
MWBW

Lock Unit
MWB-UT

Auto Switch

Made to Order

MWB-UT Series

Construction

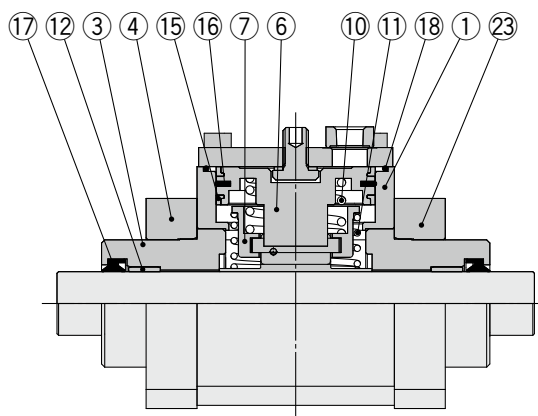
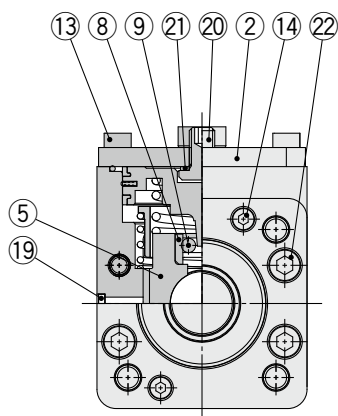

Component Parts

No.	Description	Material	Qty.	Note
1	Brake unit	Aluminum alloy	1	Hard anodized
2	Cap	Rolled steel	1	Zinc chromated
3	Collar	Aluminum alloy	2	Chromated
4	Retaining plate	Aluminum alloy	1	Anodized
5	Brake pad	Cast iron	1	
6	Piston A	Aluminum alloy	1	
7	Roller holder	Carbon steel	1	
8	Roller receiver	Stainless steel	2	Heat treated
9	Needle roller	Carbon steel	2	Heat treated
10	Piston spring	Spring steel	1	Zinc chromated
11	Roller spring	Spring steel	1	Zinc chromated
12	Bushing	Bearing alloy	2	

No.	Description	Material	Qty.	Note
13	Hexagon socket head cap screw	Alloy steel	4	
14	Hexagon socket head cap screw	Alloy steel	2	
15	Wear ring	Resin	2	
16	Piston seal	NBR	1	
17	Rod seal	NBR	2	
18	Gasket	NBR	1	
19	Element	Bronze	1	
20	Release bolt	Alloy steel	1	
21	Seal washer	NBR + Stainless steel	1	
22	Hexagon socket head cap screw	Alloy steel	4	
23	Unit cover	Aluminum alloy	1	

* The lock unit cannot be disassembled.

Dimensions

Basic: MWBB□-UT-□

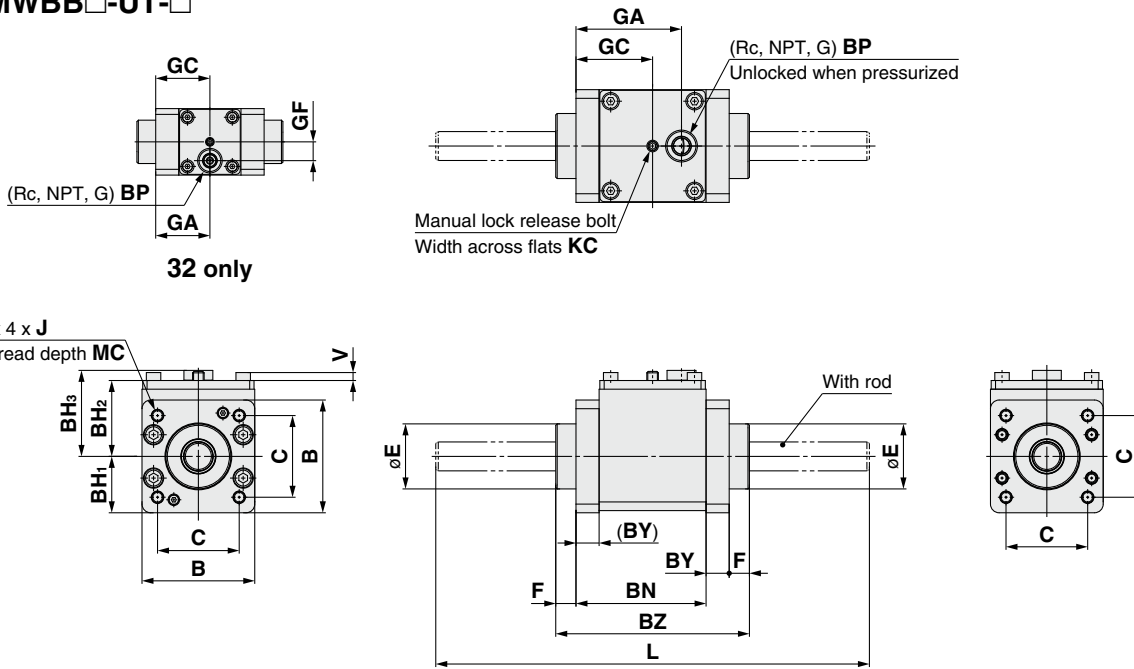

Model	Applicable rod size	B	BH ₁	BH ₂	BH ₃	BN	BP	BY	BZ	C	E	F	GA	GC	GF	J	KC	MC	V
32	ø12 f8	46	23	38.5	46.5	59	1/8	16	101	32.5	30	13	37.5	37.5	13	M6 x 1.0	3	16	3.5
40	ø16 f8	57	28.5	42.5	48.5	73	1/8	16	115	38	35	13	59.5	44.5	—	M6 x 1.0	3	16	4.5
50	ø20 f8	66	33	49	55.5	78	1/8	16	122	46.5	40	14	64	47	—	M8 x 1.25	4	16	4.5
63	ø20 f8	78	39	52.5	59.5	90	1/4	16	134	56.5	45	14	73	53	—	M8 x 1.25	4	16	5.5
80	ø25 f8	98	49	64.5	71.5	113	1/4	17	170	72	45	20	92	65	—	M10 x 1.5	5	17	7.5
100	ø30 f8	116	58	73.5	80.5	131	1/4	17	188	89	55	20	109	74	—	M10 x 1.5	5	17	9.5

⚠ Caution

The piston rod end shape should be as shown below. Chamfer the rod end to be inserted into the lock unit as shown in the figures below to prevent the seal and inner periphery of the lock unit from being scratched.

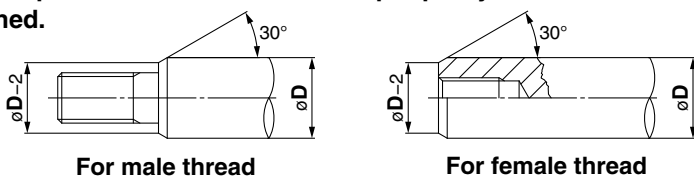

With Rod

Model	L	
	Min. length	Max. length
32	250	2500*1
40	250	
50	300	
63	300	
80	300	
100	300	

*1 The maximum rod length of the MWB□32-XC68 is 1800 mm.

Axial foot: MWBL□-UT-□

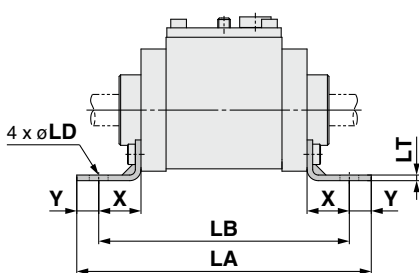

Flange: MWBF□-UT-□

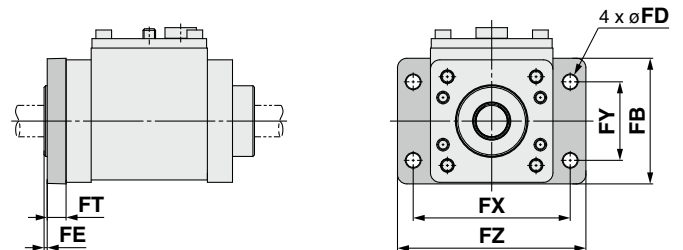

Model	LA	LB	LD	LH	LT	LX	LY	LZ	X	Y
32	137	119	7	30	3.2	32	68.5	50	22	9
40	159	137	9	33	3.2	38	75.5	55	24	11
50	170	148	9	40	3.2	46	89	70	27	11
63	188	160	12	48	3.6	56	100.5	80	27	14
80	218	190	12	55	4.5	72	119.5	100	30	14
100	244	212	14	65	4.5	89	138.5	120	32	16

Model	FB	FD	FE	FT	FX	FY	FZ
32	56	7	3	10	72	38	87
40	65	9	3	10	83	46	101
50	77	9	2	12	100	52	120
63	92	9	2	12	115	62	135
80	100	12	4	16	126	63	153
100	120	14	4	16	150	75	178

Made to Order Individual Specifications

Please contact SMC for detailed dimensions, specifications, and lead times.

1 Dimensionally Compatible with the MNB Series

Symbol
-X3000

MNB(W) series cylinders can easily be replaced with MWB(W) series cylinders.

How to Order

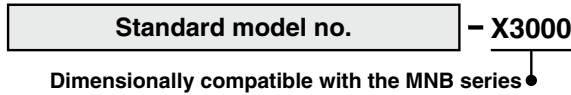

Cylinder Specifications

Bore size	32	40	50	63	80	100
Action	Double acting, Single rod/Double rod					
Max. operating pressure	1.0 MPa					
Min. operating pressure	0.08 MPa					
Piston speed*1	50 to 1000 mm/s					
Rod boot	None					
Cushion*2	Air cushion					
Port size (Rc, NPT, G)	1/8	1/4		3/8		1/2
Mounting*3	Basic, Axial foot, Rod flange, Head flange, Single clevis, Double clevis					

*1 Load limits exist depending upon the piston speed when locked, mounting direction, and operating pressure.

*2 Only an air cushion is available.

*3 Center trunnion type is not available.

Dimensions

Single rod

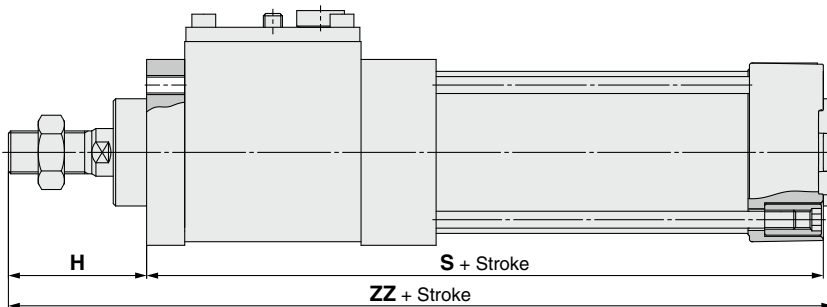

Bore size	H	S	ZZ
32	47	154	205
40	51	161	216
50	58	183	245
63	58	197	259
80	72	245	321
100	72	265	341

Double rod

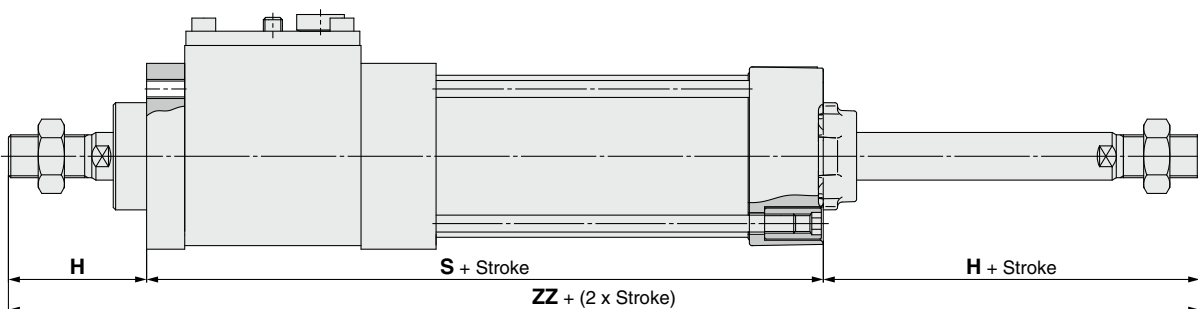

Bore size	H	S	ZZ
32	47	154	248
40	51	161	263
50	58	183	299
63	58	197	313
80	72	245	389
100	72	265	409

Symbol

2 With Lock Status Indication

-X3030 

Safety Measure

Whether the cylinder is in a locked or manual lock released state can be visually confirmed at a glance.

The high visibility of the

lock released state indication label (yellow)

allows for easy confirmation of the lock released state, even from a distance.

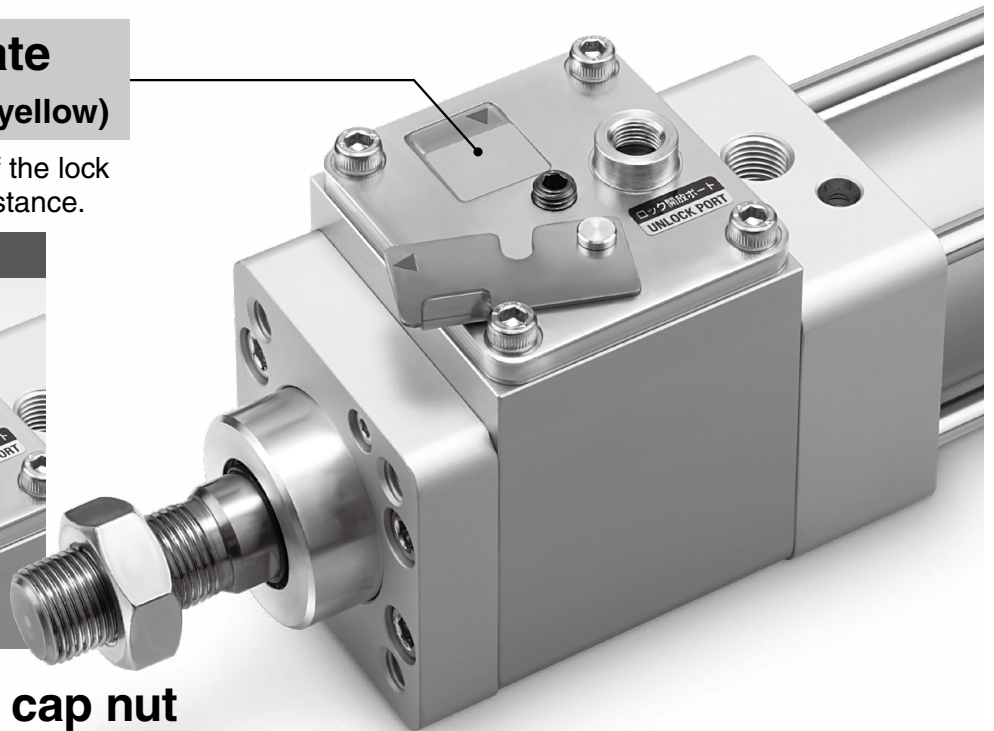

Available with a cap nut

Prevents the adhesion of spatter, foreign matter, etc.



How to Order

MWB Standard model no.

-X3030 A

MWB Lock unit
Standard model no.

With lock status indication

Option

A	None
B	With cap nut
C	With coil scraper
D	With coil scraper + cap nut

* The model with a coil scraper is the same as the MWB-XC35.

MWB specifications

Bore size	32	40	50	63	80	100
Rod boot	None					
Specifications other than the above	Same as the standard type					

MWB lock unit specifications:
The same as those of the standard MWB-UT series model

The dimensions are the same as those of the standard MWB and MWB-UT series models.

Model Selection

Double Acting, Single Rod
MWB

Double Acting, Double Rod
MWBW

Lock Unit
MWB-UT

Auto Switch

Made to Order

2 With Lock Status Indication

-X3030

Changing from the manual lock released state to the locked state

1 Turn the lock release bolt counterclockwise.

1. Continue to turn the bolt counterclockwise until the groove in the middle of the lock release bolt is completely above the body surface.

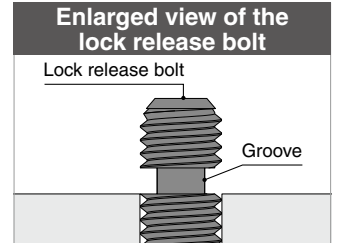
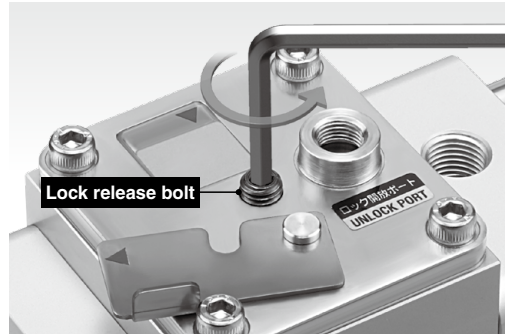

2 Align the groove and the locked state indication plate.

1. Insert the locked state indication plate into the groove in the bolt and align the orientation marks until the lock released state indication label (yellow) is no longer visible.

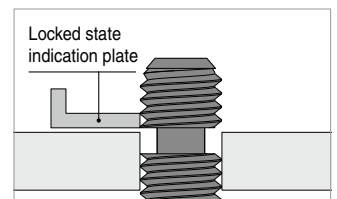
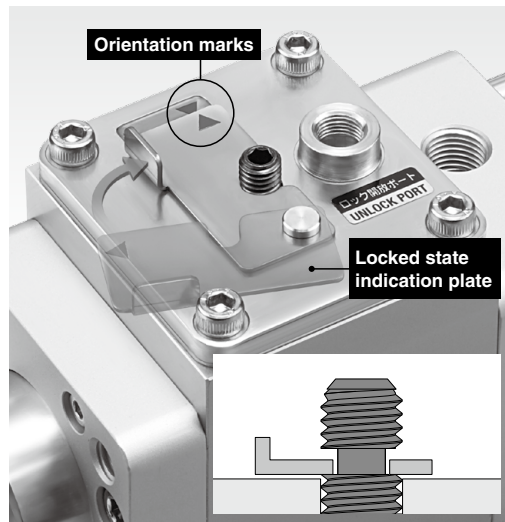

* If the bolt is not sufficiently turned counterclockwise, the groove position will not be aligned and the locked state indication plate cannot be inserted.

3 Secure the locked state indication plate.

1. Continue to turn the lock release bolt counterclockwise.
2. The locked state indication plate will move upward, securing it.
3. Confirm that the locked state indication plate does not move.

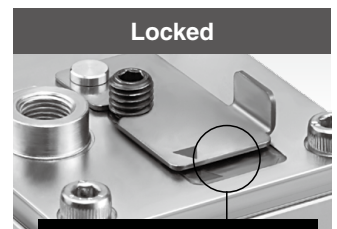
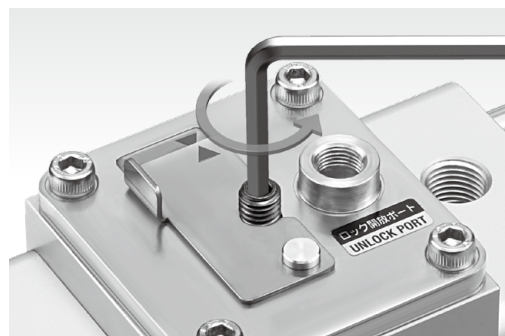

Lifting of the end of the locked state indication plate

* When the locked state indication plate is secured, the end of the plate will be lifted slightly.

⚠ Caution

Before operating the cylinder, be sure to first carry out a test operation to check for operation abnormalities as stated in the precautions in the MWB Series Operation Manual on the SMC website.

3 ISO 13849-1 Safety Standard Compliant Product / Cylinder with Brake/Lock Unit **-X3075**

Symbol

- As this is an ISO 13849-1 safety standard compliant product, it does not have a manual lock release holding mechanism.
 - It can be used in machinery as a safety component of safety-related parts.
- However, the product does not provide safety on its own.**



Category	1
Machinery directive	2006/42/EC
Harmonized standards	EN ISO13849-1:2015
	EN ISO13849-2:2012
	EN ISO4414:2010

How to Order Cylinder with Brake/Lock Unit



M **WB** **B** **40** **-** **50** **-** **X3075**

Built-in magnet

Nil	Without magnet
D	Built-in magnet

Mounting

B	Basic
L	Axial foot
F	Rod flange
G	Head flange
C	Single clevis
D	Double clevis
T	Center trunnion

Port thread type

Nil	Rc
TN	NPT
TF	G

Bore size

32	32 mm
40	40 mm
50	50 mm
63	63 mm
80	80 mm
100	100 mm

Cylinder stroke [mm]
Refer to "Standard Stroke (Table 2)" below.

Table 1

Bore size [mm]	Usage	
	Lock	Brake
32	OK	OK
40	OK	OK
50	OK	OK
63	OK	OK
80	OK	OK
100	OK	OK

This product provides braking function and locking function.

These functions are defined as follows:

- Braking means to stop a moving object (intermediate stop or emergency stop).
- Locking means to retain a stationary object in place (drop prevention or holding position).

Table 2 Standard Stroke

Bore size	Standard stroke	
	Stroke range ①	Stroke range ②
32	25, 50, 75, 100, 125, 150, 175, 200, 250, 300, 350, 400, 450, 500	Up to 1000
40	25, 50, 75, 100, 125, 150, 175, 200, 250, 300, 350, 400, 450, 500	Up to 1800
50	25, 50, 75, 100, 125, 150, 175, 200, 250, 300, 350, 400, 450, 500, 600	
63	25, 50, 75, 100, 125, 150, 175, 200, 250, 300, 350, 400, 450, 500, 600	
80	25, 50, 75, 100, 125, 150, 175, 200, 250, 300, 350, 400, 450, 500, 600, 700, 800	
100	25, 50, 75, 100, 125, 150, 175, 200, 250, 300, 350, 400, 450, 500, 600, 700, 800	

* The manufacturing of intermediate strokes is possible. (Spacers are not used.)

* Applicable strokes should be confirmed according to the usage. For details, refer to the Air Cylinders Model Selection in the **Web Catalog**. In addition, products that exceed the stroke range ① might not be able to fulfill the specifications due to deflection, etc.

Specifications

Bore size [mm]	32	40	50	63	80	100
Action	Double acting, Single rod					
Cushion	Air cushion					
Auto switch	None					
Rod boot	None					
Other specifications	Same as standard type					

* Pivot brackets, rod end brackets, etc., are not included.

Dimensions: Same as the standard MWB

Model Selection

Double Acting, Single Rod
MWB

Double Acting, Double Rod
MWBW

Lock Unit
MWB-UT

Auto Switch

Made to Order

3 ISO 13849-1 Safety Standard Compliant Product / Brake/Lock Unit

- As this is an ISO 13849-1 safety standard compliant product, it does not have a manual lock release holding mechanism.
- It can be used in machinery as a safety component of safety-related parts.
However, the product does not provide safety on its own.



Category	1
Machinery directive	2006/42/EC
Harmonized standards	EN ISO13849-1:2015
	EN ISO13849-2:2012
	EN ISO4414:2010

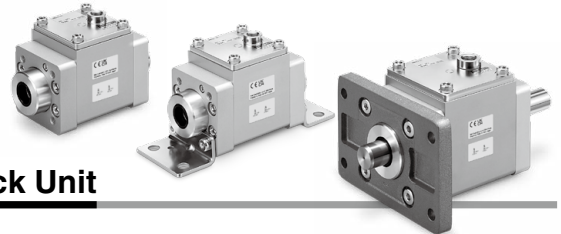

How to Order Brake/Lock Unit

MWB B 40 [] - UT - X3075

With rod MWB B 40 [] - UT - 500 - X3075

Mounting

B	Basic
L	Axial foot
F	Flange

* Mounting bracket is shipped together with the product.

Model

Model	Applicable rod size
32	12 mm
40	16 mm
50	20 mm
63	20 mm
80	25 mm
100	30 mm

Port thread type

Nil	Rc
TN	NPT
TF	G

Rod length [mm]

Nil		Without accessory rod	
Min. length	Max. length	Applicable model	Note
250	2500	32	Can be manufactured in increments of 1 mm up to the maximum length.
300		40	
		50	
		63	
		80	
		100	

* The rod length indicates the overall length of the rod.

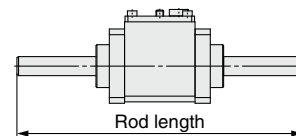

* Rod is shipped together with the product.

Table 1

Bore size [mm]	Usage	
	Lock	Brake
32	OK	OK
40	OK	OK
50	OK	OK
63	OK	OK
80	OK	OK
100	OK	OK

This product provides braking function and locking function.

These functions are defined as follows:

- Braking means to stop a moving object (intermediate stop or emergency stop).
- Locking means to retain a stationary object in place (drop prevention or holding position).

Specifications and dimensions: Same as the standard MWB-UT

⚠ Caution

As this product does not have a manual lock release holding mechanism, supply air pressure to the lock port to release the lock.

MWB Series Simple Specials

The following changes are dealt with through the Simple Specials System.

Please contact your local sales representative for more details.

1 Change of Rod End Shape Symbol -XA0 to XA30

Series		Action	Symbol for change of rod end shape	Note
Standard	MWB	Double acting, Single rod	XA0 to 30	Excludes cylinders with a rod end bracket
Lock unit	MWB-UT	—	XA1 to 30	Excludes XA2, XA9, XA12, XA24, XA25

Precautions

- SMC will make appropriate arrangements if no dimension, tolerance, or finish instructions are given in the diagram.
- Standard dimensions marked with "*" will be as follows to the rod diameter (D). Enter any special dimension you require.
6 < D ≤ 25 → D-2 mm, D > 25 → D-4 mm
- "A0" is the same shape as the standard type. (Excludes MWB-UT. The specifications of A0 are that only dimensions A and H are changed from the standard type.)
- For the MWB-UT, there is no need to specify an H dimension.
- For the MWB-UT, to change 1 side, specify on 1 Simple Specials specification sheet, and to change both sides, specify on 2 Simple Specials specification sheets.

Symbol: A0 	Symbol: A1 	Symbol: A2 	Symbol: A3
Symbol: A4 	Symbol: A5 	Symbol: A6 	Symbol: A7
Symbol: A8 	Symbol: A9 	Symbol: A10 	Symbol: A11
Symbol: A12 	Symbol: A13 	Symbol: A14 	Symbol: A15
Symbol: A16 	Symbol: A17 	Symbol: A18 	Symbol: A19

Model Selection

Double Acting, Single Rod
MWB

Double Acting, Double Rod
MWBW

Lock Unit
MWB-UT

Auto Switch

Made to Order

MWB Series

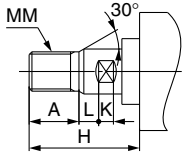
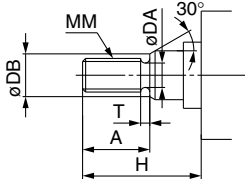
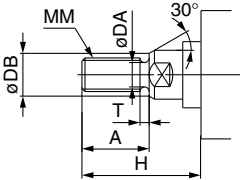
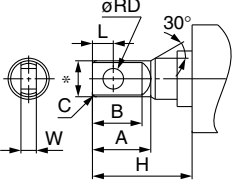
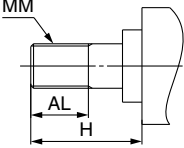
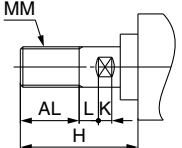
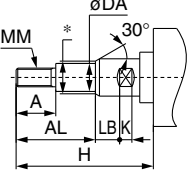
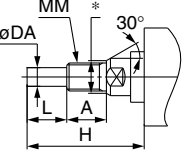
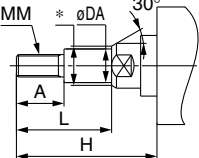
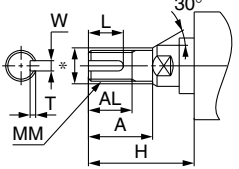
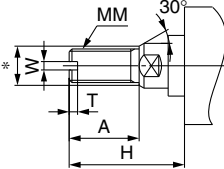
<p>Symbol: A20</p> 	<p>Symbol: A21</p> 	<p>Symbol: A22</p> 	<p>Symbol: A23</p> 
<p>Symbol: A24</p> 	<p>Symbol: A25</p> 	<p>Symbol: A26</p> 	<p>Symbol: A27</p> 
<p>Symbol: A28</p> 	<p>Symbol: A29</p> 	<p>Symbol: A30</p> 	

Made to Order Common Specifications

Please contact SMC for detailed dimensions, specifications, and lead times.

1 With Coil Scraper

Symbol
-XC35

It gets rid of frost, ice, weld spatter, cutting chips adhered to the piston rod, and protects the seals, etc.

Applicable Series

Description	Model	Action	Note
Standard	MWB	Double acting, Single rod	—
	MWBW	Double acting, Double rod	—
	MWB-UT	—	Lock unit

How to Order

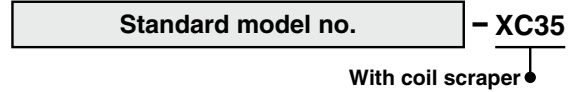

Specifications and dimensions: Same as standard

Construction

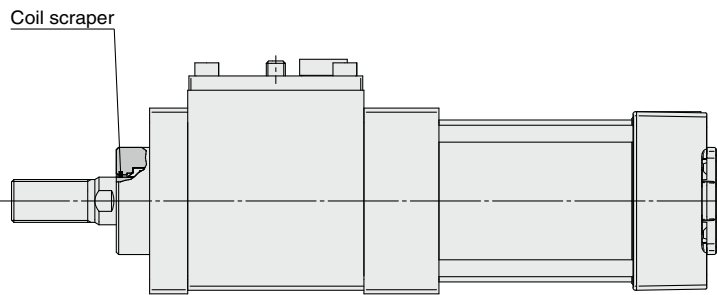

Cylinder with lock

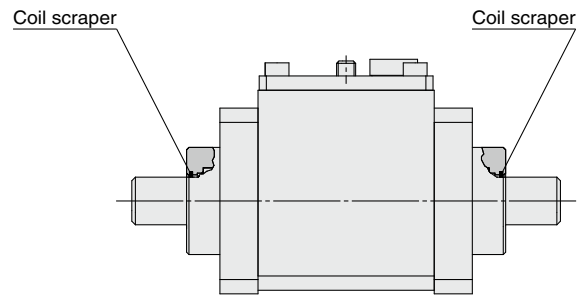

Lock unit

2 Made of Stainless Steel (For Lock Unit, With Hard Chrome Plating)

Symbol
-XC68

Suitable for environments where rust and corrosion are likely to be generated.

Applicable Series

Description	Model	Note
Standard	MWB-UT	Lock unit

How to Order

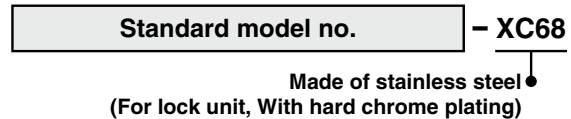

Specifications and dimensions: Same as standard

Stainless Steel Rod Length

Model	Min. length	Max. length	Note
32	250 mm	1800 mm	Can be manufactured in increments of 1 mm up to the maximum length.
40	250 mm	2500 mm	
50	300 mm		
63	300 mm		
80	300 mm		
100	300 mm		

Model Selection

Double Acting, Single Rod
MWB

Double Acting, Double Rod
MWBW

Lock Unit
MWB-UT

Auto Switch

Made to Order



MWB Series

Specific Product Precautions 1

Be sure to read this before handling the products. Refer to the back cover for safety instructions. For actuator and auto switch precautions, refer to the "Handling Precautions for SMC Products" and the "Operation Manual" on the SMC website: <http://www.smcworld.com>

Design of Equipment and Machinery

Warning

1. Construct so that the human body will not come into direct contact with driven objects or the moving parts of the cylinders with lock.

Devise a safe structure by attaching protective covers that prevent direct contact with the human body, or in cases where there is a danger of contact, provide sensors or other devices to perform an emergency stop, etc., before contact occurs.

2. Use a balance circuit, taking cylinder lurching into consideration.

In cases such as an intermediate stop, where a lock is operated at a desired position within the stroke and air pressure is applied from only one side of the cylinder, the piston will lurch at high speed when the lock is released. In such situations, there is a danger of causing human injury by having hands or feet, etc. caught, and also a danger for causing damage to the equipment. In order to prevent this lurching, a balance circuit such as the recommended pneumatic circuits (page 41) should be used.

Selection

Warning

1. When in the locked state, do not apply a load accompanied by an impact shock, strong vibration or turning force, etc.

Use caution, because an external action such as an impacting load, strong vibration or turning force, may damage the locking mechanism or reduce its life.

2. Consider stopping accuracy and the amount of overrun when an intermediate stop is performed.

Due to the nature of a mechanical lock, there is a momentary lag with respect to the stop signal, and a time delay occurs before stopping. The cylinder stroke resulting from this delay is the overrun amount. The difference between the maximum and minimum overrun amounts is the stopping accuracy.

- Place a limit switch before the desired stopping position, at a distance equal to the overrun amount.
- The limit switch must have a detection length (dog length) of the overrun amount + α .
- SMC's auto switches have operating ranges from 8 to 14 mm (depending on the auto switch model).

When the overrun amount exceeds this range, self-holding of the contact should be performed at the auto switch load side.

* For the stopping accuracy, refer to page 8.

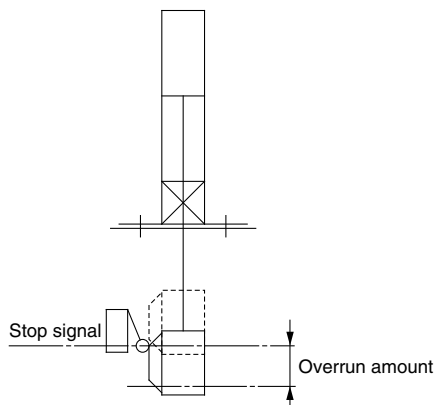

Selection

Warning

3. In order to further improve stopping accuracy, the time from the stop signal to the operation of the lock should be shortened as much as possible.

To accomplish this, use a device such as a highly responsive electric control circuit or solenoid valve, and place the solenoid valve as close as possible to the cylinder.

4. Note that the stopping accuracy will be influenced by changes in piston speed.

When piston speed changes during the course of the cylinder stroke due to variations in the load or disturbances, etc., the dispersion of stopping positions will increase. Therefore, consideration should be given to establishing a standard speed for the piston just before it reaches the stopping position.

Moreover, the dispersion of stopping positions will increase during the cushioned portion of the stroke and during the accelerating portion of the stroke after the start of operation, due to the large changes in piston speed.

5. The holding force (max. static load) indicates the maximum capability to hold a static load without loads, vibration and impact. This does not indicate a load that can be held in ordinary conditions.

Select the most suitable bore sizes for the operating conditions in accordance with the selection procedures. The Model Selection (pages 5 and 6) is based on use at the intermediate stop (including emergency stops during operation). However, when the cylinder is in a locked state, kinetic energy does not act upon it. Under these conditions, use the load mass at the maximum speed (V) of 100 mm/s shown in graphs [5] to [7] on page 6 depending on the operating pressure and select models.

Mounting

Warning

1. The manual lock is released as default. The lock will not operate in this condition. Before starting operation, engage the lock.

2. Be certain to connect the rod end to the load with the lock released.

If connected in the locked state, a load greater than the turning force or holding force, etc. may operate on the piston rod and cause damage to the lock mechanism. As the MWB series is equipped with a manual lock release mechanism, it is possible to hold the lock released state without an air supply.

3. Do not apply offset loads to the piston rod.

Particular care should be taken to match the load's center of gravity with the center of the cylinder shaft. When there is a large discrepancy, the piston rod may be subjected to uneven wear or damage due to the inertial moment during locking stops.

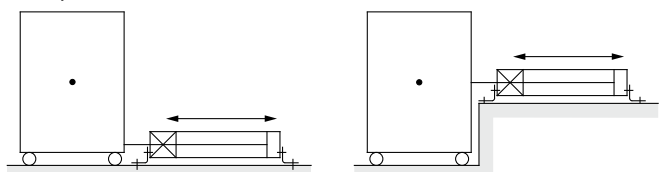

X Load center of gravity and cylinder shaft center are not matched.

O Load center of gravity and cylinder shaft center are matched.

* Can be used if all of the generated moment is absorbed by an effective guide.



MWB Series

Specific Product Precautions 2

Be sure to read this before handling the products. Refer to the back cover for safety instructions. For actuator and auto switch precautions, refer to the “Handling Precautions for SMC Products” and the “Operation Manual” on the SMC website: <http://www.smcworld.com>

Mounting

⚠ Caution

1. Use the hexagon wrenches shown below when replacing brackets.

Bore size [mm]	Bolt	Hexagon wrench size	Tightening torque [N·m]
32, 40	MB-32-48-C1247	4	5.1
50, 63	MB-50-48-C1249	5	11
80, 100	Foot bracket	MB-80-48AC1251	25
	Other	MB-80-48BC1251	

2. When replacing the head side bracket, the tie-rod nut on the cylinder body also loosens.

After retightening the tie-rod nut at the proper tightening torque (refer to the Mounting 1. above.), install the bracket.

3. Do not turn the piston rod with the rod boot kept locked.

When turning the piston rod, loosen the band once and do not twist the rod boot.

Set the breathing hole in the rod boot downward or in the direction that prevents entry of dust or water content.

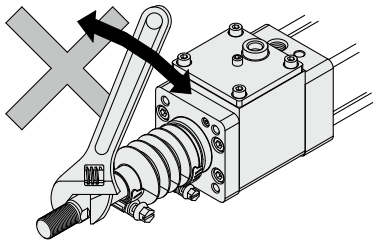

4. Do not disassemble the trunnion type cylinder because the mounting precision is required.

It is difficult to align the axial center of the trunnion with the axial center of the cylinder. Thus, if this type of cylinder is disassembled and reassembled, the required dimensional accuracy cannot be attained, which may lead to malfunctions.

Adjustment

⚠ Warning

1. Do not open the cushion valve beyond the stopper.

As a retaining mechanism for the cushion valve, a crimped section ($\phi 32$) or retaining ring ($\phi 40$ to $\phi 100$) is installed, and the cushion valve should not be opened beyond that point.

If not operated in accordance with the above precautions, the cushion valve may be ejected from the cover when air pressure is supplied.

Bore size [mm]	Hexagon wrench size of cushion valve
32, 40	2.5
50, 63	3
80, 100	4

2. Use the air cushion at the end of cylinder stroke.

If air cushion is not intended to be used at the stroke end, select the cylinder with rubber bumper.

If this is not done, the tie-rod or piston assembly will be damaged.

Adjustment

⚠ Caution

1. Adjust the cylinder's air balance.

Balance the load by adjusting the air pressure in the rod and head sides of the cylinder with the load connected to the cylinder and the lock released. Lurching of the cylinder when unlocked can be prevented by carefully adjusting this air balance.

2. Adjust the mounting positions of the detectors on auto switches, etc.

When intermediate stops are to be performed, adjust the mounting positions of detectors on auto switches, etc., taking into consideration the overrun amount with respect to the desired stopping positions.

Pneumatic Circuit

⚠ Warning

1. Be certain to use a pneumatic circuit which will apply balancing pressure to both sides of the piston when in a locked stop.

In order to prevent cylinder lurching after a lock stop, when restarting or when manually unlocking, a circuit should be used to which will apply balancing pressure to both sides of the piston, thereby canceling the force generated by the load in the direction of piston movement.

2. The effective area of the unlocking solenoid valve should be at least 50% of the effective area of the cylinder driving solenoid valve, and it should be installed as close to the cylinder as possible so that it is closer than the cylinder driving solenoid valve.

If the effective area of the unlocking solenoid valve is small or if it is installed at a distance from the cylinder, the time required for exhausting air for unlocking will be longer, which may cause a delay in the locking operation.

The delay in the locking operation may result in problems such as increase of overruning when performing intermediate stop or emergency stop during operation, or if maintaining position from the operation stop state such as drop prevention, workpieces may be dropped depending on the timing of the load action to the operation delay of the lock.

3. Avoid backflow of the exhaust pressure when there is a possibility of interference of exhaust air, for example for a common exhaust type valve manifold.

The lock may not operate properly when the exhaust air pressure backflows due to interference of the exhaust air when exhausting air for lock release. It is recommended to use an individual exhaust type manifold or individual valves.

4. Allow at least 0.5 seconds from a locked stop (intermediate stop of the cylinder) until release of the lock.

When the locked stop time is too short, the piston rod (and load) may lurch at a speed greater than the control speed of the speed controller.

5. When restarting, control the switching signal for the unlocking solenoid valve so that it acts before or at the same time as the cylinder drive solenoid valve.

If the signal is delayed, the piston rod (and load) may lurch at a speed greater than the control speed of the speed controller.

6. Carefully check for dew condensation due to repeated air supply and exhaust of the locking solenoid valve.

The operating stroke of the lock part is very small. So, if the piping is long and the air supply and exhaust are repeated, the dew condensation caused by the adiabatic expansion accumulates in the lock part. This may corrode internal parts, causing air leak or lock release fault.



MWB Series Specific Product Precautions 3

Be sure to read this before handling the products. Refer to the back cover for safety instructions. For actuator and auto switch precautions, refer to the "Handling Precautions for SMC Products" and the "Operation Manual" on the SMC website: <http://www.smcworld.com>

Pneumatic Circuit

Warning

7. Basic circuit

1. [Horizontal]

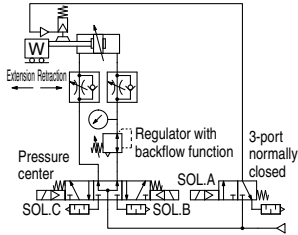

SOL.A	SOL.B	SOL.C	Action
ON	ON	OFF	Extension
OFF	OFF	OFF	Locked stop
ON	OFF	OFF	Unlocked
ON	ON	OFF	Extension
ON	OFF	ON	Retraction
OFF	OFF	OFF	Locked stop
ON	OFF	OFF	Unlocked
ON	OFF	ON	Retraction

0.5 s or more
0 to 0.5 s
0.5 s or more
0 to 0.5 s

2. [Vertical]

[Load in the direction of rod extension]

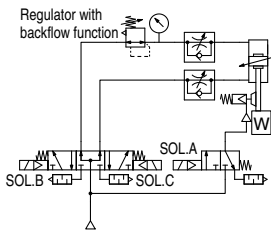

[Load in the direction of rod retraction]

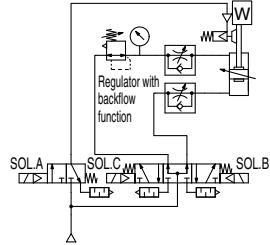

Caution

- 3-position pressure center solenoid valve and regulator with backflow function can be replaced with two 3-port normally open valves and a regulator with relief function.

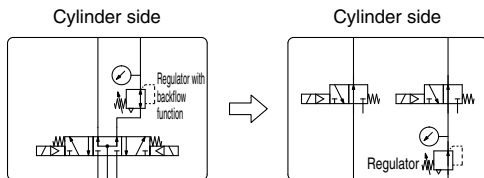

[Example]

1. [Horizontal]

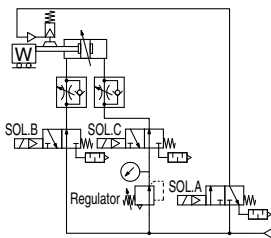

2. [Vertical]

[Load in the direction of rod extension]

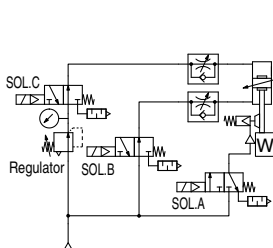

[Load in the direction of rod retraction]

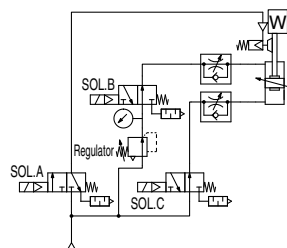

Manual Lock Release

Warning

- Never operate the lock release bolt until safety has been confirmed.

- When unlocking is performed with air pressure applied to only one side of the cylinder, the moving parts of the cylinder will lurch at high speed causing a serious hazard.
- When unlocking is performed, be sure to confirm that personnel are not within the load movement range and that no other problems will occur if the load moves.

- Before operating the lock release bolt, exhaust any residual pressure which is in the system.

- Take measures to prevent the load from dropping.

- Perform work with the load in its lowest position.
- Take measures for drop prevention by strut, etc.

Caution

- When releasing the locked state with the lock release bolt for the purpose of mounting or adjustment, be sure to return the lock release bolt to the locked state.

If the lock release bolt is not returned to the locked state, the lock might not function correctly or lock release might not be completed due to air leakage from the lock release bolt.

[How to return to locked state]

- Rotate the lock release bolt counterclockwise by hand with a hexagon wrench until it stops. Once that position is reached, rotate it an additional 1/6th of a turn to securely tighten the lock release bolt.

* Do not use an electric screwdriver or pneumatic screwdriver.

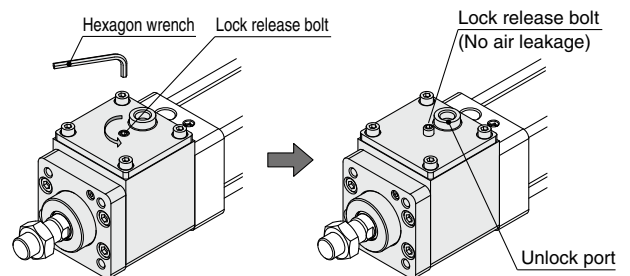

Manual lock released

Locked

Bore size [mm]	Hexagon wrench size of the lock release bolt
32, 40	3
50, 63	4
80, 100	5

- Pressurize the unlock port with 0.3 MPa or more and check that there is no air leakage from the lock release bolt and lock correctly functions.



MWB Series Specific Product Precautions 4

Be sure to read this before handling the products. Refer to the back cover for safety instructions. For actuator and auto switch precautions, refer to the “Handling Precautions for SMC Products” and the “Operation Manual” on the SMC website: <http://www.smcworld.com>

Maintenance

⚠ Caution

1. Lock units are replaceable.

When ordering the lock unit for maintenance, select the suitable lock based on the cylinder bore size.

Bore size [mm]	Port type	Replacement lock unit part no.
32	Rc	MWB32-UA
	NPT	MWB32TN-UA
	G	MWB32TF-UA
40	Rc	MWB40-UA
	NPT	MWB40TN-UA
	G	MWB40TF-UA
50	Rc	MWB50-UA
	NPT	MWB50TN-UA
	G	MWB50TF-UA
63	Rc	MWB63-UA
	NPT	MWB63TN-UA
	G	MWB63TF-UA
80	Rc	MWB80-UA
	NPT	MWB80TN-UA
	G	MWB80TF-UA
100	Rc	MWB100-UA
	NPT	MWB100TN-UA
	G	MWB100TF-UA

* For lock unit with a rod boot, add -J to the part number suffix.
Example) MWB50-UA-J

2. How to replace lock units

1) To release the locked state, screw-in the lock release bolt to the body cap end or pressurize the unlock port with 0.3 MPa or more.

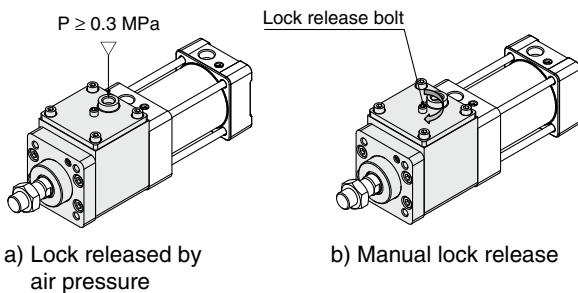

2) Remove the lock unit holding bolt (hexagon socket head cap screw) with a hexagon wrench. For the applicable hexagon wrench, refer to the table below.
If using the rod end nut, remove it.

Bore size [mm]	Hexagon wrench size of the lock holding bolt
32	3
40, 50	5
63	6
80	8
100	10

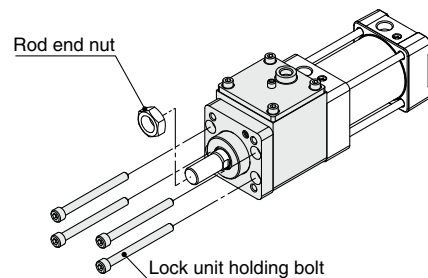

3) Pull out the old lock unit from the cylinder.

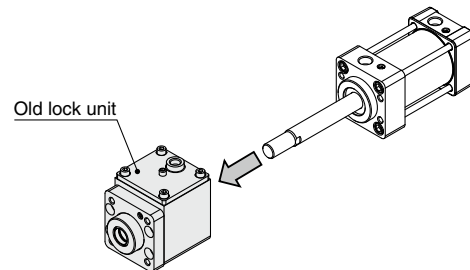

4) Insert a new lock unit into the cylinder.
The lock unit for maintenance is supplied with lock released state at the shipment from the factory.

Note)

Do not lock and operate the lock unit the lock unit has been mounted to the cylinder.

If the lock unit is operated before the rod has been inserted, the lock may not release properly and it will be difficult to insert the rod.

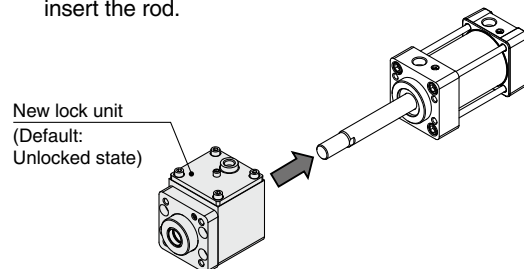



MWB Series Specific Product Precautions 5

Be sure to read this before handling the products. Refer to the back cover for safety instructions. For actuator and auto switch precautions, refer to the “Handling Precautions for SMC Products” and the “Operation Manual” on the SMC website: <http://www.smcworld.com>

Maintenance

Caution

- 5) Insert the lock unit holding bolt and tighten it temporarily. Check that the piston rod operates smoothly by hand while maintaining the lock released state.

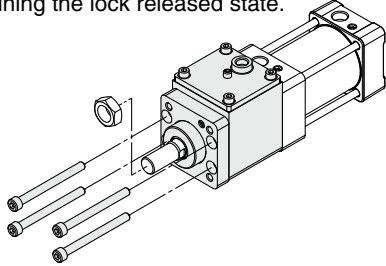

- 6) Confirm that the operation of 5) above is performed correctly, and then tighten the lock unit holding bolt with an appropriate tightening torque as shown in the table below.

Bore size [mm]	Appropriate tightening torque of the lock unit holding bolt [N·m]
32	1.35 to 1.65
40, 50	4.7 to 5.7
63	11.3 to 13.7
80	22.1 to 26.9
100	37.8 to 46.2

- 7) After assembly is completed, rotate the lock release bolt counterclockwise by hand with a hexagon wrench until it stops. Once that position is reached, rotate it for an additional 1/6th of a turn to securely tighten the lock release bolt.

* Do not use an electric screwdriver or pneumatic screwdriver.

Bore size [mm]	Hexagon wrench size of the lock release bolt
32, 40	3
50, 63	4
80, 100	5

Lock release bolt
(Lock here)

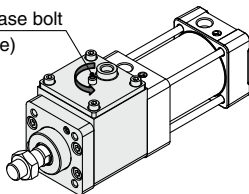

Check that the cylinder is locked and confirm that the lock is released when air pressure of 0.3 MPa or more is applied to the unlock port on the lock unit. In addition to this, the piston rod should operate smoothly with the minimum operating pressure. Check that there is no air leakage from the lock release bolt.



MWB□-UT Series Specific Product Precautions 6

Be sure to read this before handling the products. Refer to the back cover for safety instructions. For actuator and auto switch precautions, refer to the “Handling Precautions for SMC Products” and the “Operation Manual” on the SMC website: <http://www.smcworld.com>

<Precautions for the lock unit MWB□-UT>

Design / Selection

- When selecting a lock unit, refer to Model Selection on pages 5 and 6.
- Use a rod of the size recommended in the following table.

Unit model	MWB32-UT	MWB40-UT	MWB50-UT	MWB63-UT	MWB80-UT	MWB100-UT
Applicable rod size	ø12 f8	ø16 f8	ø20 f8	ø20 f8	ø25 f8	ø30 f8
Material	Carbon steel/Stainless steel					
Surface treatment	Hard chrome plating: 10 μm					
Surface roughness	Maximum height: Rz 1.6 or less					

Using any rod other than the rods recommended above may cause damage to internal parts of the lock unit, faulty mounting of the lock unit, operation failure, decrease in holding force, etc.

- The lock unit may be damaged if an excessive lateral load or external force is applied to it. Fully consider this point.
- Do not use the lock unit for any application where the rod rotates.
- When in the locked state, do not apply a load accompanied by an impact shock, strong vibration, turning force, etc.
Note that an external action, such as an impacting load, strong vibration, or turning force, may damage the lock unit or reduce its life.
- Excessively long piping between the unlock port of the lock unit and the solenoid valve for the lock, or a pipe that is too small may affect the stopping accuracy of the lock unit.
- When unlocking is performed from the locked state with some thrust or load still applied to the lock unit, cylinder lurching may occur. In addition, frequent occurrence of excessive cylinder lurching or a similar problem due to the load being applied will damage the lock unit or reduce its life. Take appropriate measures for the circuit and/or the system. When using the lock unit in combination with a pneumatic cylinder, cylinder lurching can be prevented by using a balance circuit, such as the recommended pneumatic circuits on page 41.
- When using the lock unit by placing it in parallel with the cylinder for driving as shown in the figure below, align the cylinder with the rod.

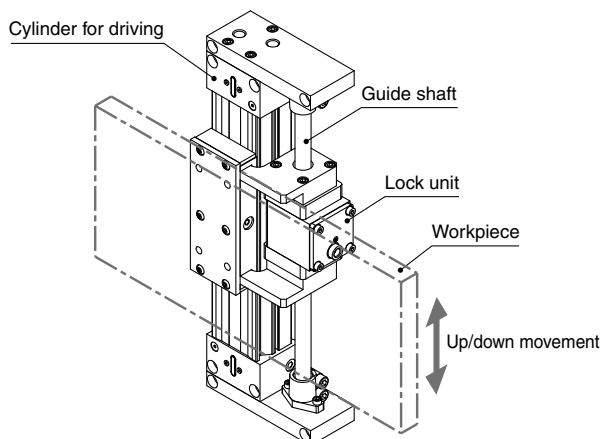

Mounting / Adjustment

- The lock unit is shipped from the factory with the lock released. Do not lock and operate the lock unit the rod has been inserted into the lock unit.

If the lock unit is operated before the rod has been inserted, the lock may not release properly and it will be difficult to insert the rod.

- Ensure that the sliding surface of the rod to be inserted into the lock unit is not scratched or dented during the mounting or adjustment of this product.

Scratches or dents on the surface of the rod may cause unusual wear on the inner surface of the brake pad or decrease its holding force.

- Chamfer the rod end to be inserted into the lock unit as shown in the figures below to prevent the seal and inner periphery of the lock unit from being scratched.

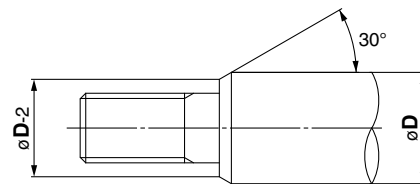

For male thread

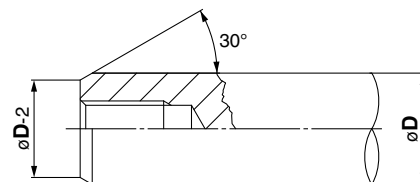

For female thread

- Refer to page 41 for the manual lock release.

Maintenance / Inspection

- Do not disassemble the lock unit and perform maintenance.

Please contact our nearest sales office when you require repair or maintenance.

- Do not apply any grease or lubricant to the inner periphery of the lock unit or the surface of the rod to be inserted into the lock unit.

Doing so may result in a decrease in holding force.

- Take additional safety measures when conducting equipment maintenance.

Safety Instructions

These safety instructions are intended to prevent hazardous situations and/or equipment damage. These instructions indicate the level of potential hazard with the labels of “**Caution**,” “**Warning**” or “**Danger**.” They are all important notes for safety and must be followed in addition to International Standards (ISO/IEC)*1), and other safety regulations.

 **Caution:** **Caution** indicates a hazard with a low level of risk which, if not avoided, could result in minor or moderate injury.

 **Warning:** **Warning** indicates a hazard with a medium level of risk which, if not avoided, could result in death or serious injury.

 **Danger :** **Danger** indicates a hazard with a high level of risk which, if not avoided, will result in death or serious injury.

*1) ISO 4414: Pneumatic fluid power – General rules relating to systems.
ISO 4413: Hydraulic fluid power – General rules relating to systems.
IEC 60204-1: Safety of machinery – Electrical equipment of machines.
(Part 1: General requirements)
ISO 10218-1: Manipulating industrial robots – Safety.
etc.

Warning

1. The compatibility of the product is the responsibility of the person who designs the equipment or decides its specifications.

Since the product specified here is used under various operating conditions, its compatibility with specific equipment must be decided by the person who designs the equipment or decides its specifications based on necessary analysis and test results. The expected performance and safety assurance of the equipment will be the responsibility of the person who has determined its compatibility with the product. This person should also continuously review all specifications of the product referring to its latest catalog information, with a view to giving due consideration to any possibility of equipment failure when configuring the equipment.

2. Only personnel with appropriate training should operate machinery and equipment.

The product specified here may become unsafe if handled incorrectly. The assembly, operation and maintenance of machines or equipment including our products must be performed by an operator who is appropriately trained and experienced.

3. Do not service or attempt to remove product and machinery/equipment until safety is confirmed.

1. The inspection and maintenance of machinery/equipment should only be performed after measures to prevent falling or runaway of the driven objects have been confirmed.
2. When the product is to be removed, confirm that the safety measures as mentioned above are implemented and the power from any appropriate source is cut, and read and understand the specific product precautions of all relevant products carefully.
3. Before machinery/equipment is restarted, take measures to prevent unexpected operation and malfunction.

4. Contact SMC beforehand and take special consideration of safety measures if the product is to be used in any of the following conditions.

1. Conditions and environments outside of the given specifications, or use outdoors or in a place exposed to direct sunlight.
2. Installation on equipment in conjunction with atomic energy, railways, air navigation, space, shipping, vehicles, military, medical treatment, combustion and recreation, or equipment in contact with food and beverages, emergency stop circuits, clutch and brake circuits in press applications, safety equipment or other applications unsuitable for the standard specifications described in the product catalog.
3. An application which could have negative effects on people, property, or animals requiring special safety analysis.
4. Use in an interlock circuit, which requires the provision of double interlock for possible failure by using a mechanical protective function, and periodical checks to confirm proper operation.

Caution

1. The product is provided for use in manufacturing industries.

The product herein described is basically provided for peaceful use in manufacturing industries.
If considering using the product in other industries, consult SMC beforehand and exchange specifications or a contract if necessary.
If anything is unclear, contact your nearest sales branch.

Limited warranty and Disclaimer/ Compliance Requirements

The product used is subject to the following “Limited warranty and Disclaimer” and “Compliance Requirements”.

Read and accept them before using the product.

Limited warranty and Disclaimer

1. The warranty period of the product is 1 year in service or 1.5 years after the product is delivered, whichever is first.*2)
Also, the product may have specified durability, running distance or replacement parts. Please consult your nearest sales branch.
2. For any failure or damage reported within the warranty period which is clearly our responsibility, a replacement product or necessary parts will be provided.
This limited warranty applies only to our product independently, and not to any other damage incurred due to the failure of the product.
3. Prior to using SMC products, please read and understand the warranty terms and disclaimers noted in the specified catalog for the particular products.

*2) Vacuum pads are excluded from this 1 year warranty.

A vacuum pad is a consumable part, so it is warranted for a year after it is delivered.
Also, even within the warranty period, the wear of a product due to the use of the vacuum pad or failure due to the deterioration of rubber material are not covered by the limited warranty.

Compliance Requirements

1. The use of SMC products with production equipment for the manufacture of weapons of mass destruction (WMD) or any other weapon is strictly prohibited.
2. The exports of SMC products or technology from one country to another are governed by the relevant security laws and regulations of the countries involved in the transaction. Prior to the shipment of a SMC product to another country, assure that all local rules governing that export are known and followed.

Caution

SMC products are not intended for use as instruments for legal metrology.

Measurement instruments that SMC manufactures or sells have not been qualified by type approval tests relevant to the metrology (measurement) laws of each country. Therefore, SMC products cannot be used for business or certification ordained by the metrology (measurement) laws of each country.

Revision History

Edition B * A lock unit has been added.

* Made to order options (With coil scraper: -XC35, Stainless steel rod: -XC68) have been added.

* Number of pages has been increased from 36 to 44. VT

Edition C * Bore sizes ø80 and ø100 have been added.

* Number of pages has been increased from 44 to 48. VX

Edition D * The minimum operating pressure of the lock unit has been changed from 0.08 MPa to 0.3 MPa.

* The shaft diameter CD of the single rod single clevis type pin mounting hole has been deleted.

* (Specific Product Precautions - Maintenance 6)) The applicable tightening torque for the lock unit holding bolt has been revised (ø40, ø50, ø63). WP

Safety Instructions

Be sure to read the “Handling Precautions for SMC Products” (M-E03-3) and “Operation Manual” before use.