

# Air Cylinder

ø20, ø25, ø32, ø40, ø50, ø63, ø80, ø100

New

RoHS

## Improved piping flexibility

- Piping can be connected every 90 degrees (4 positions).
- Suitable piping position can be selected during designing phase.

(Made to order: **XC3** p.24)

Port location viewed from the rod side

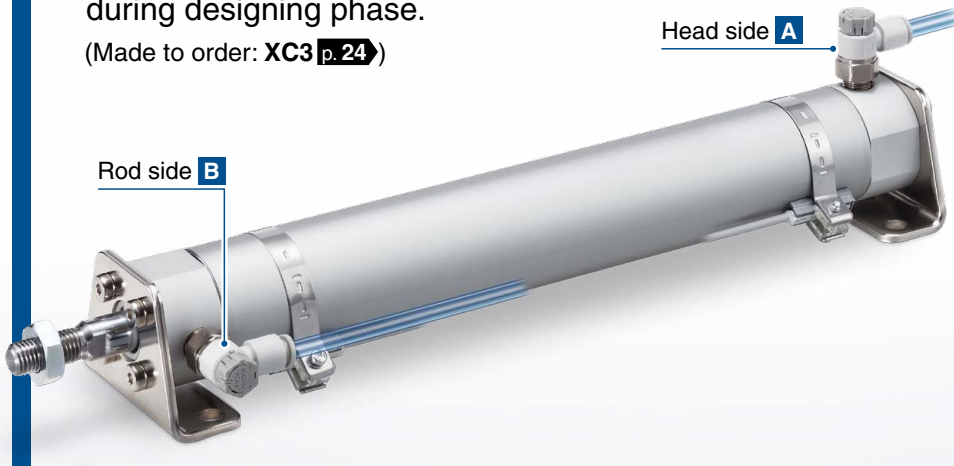
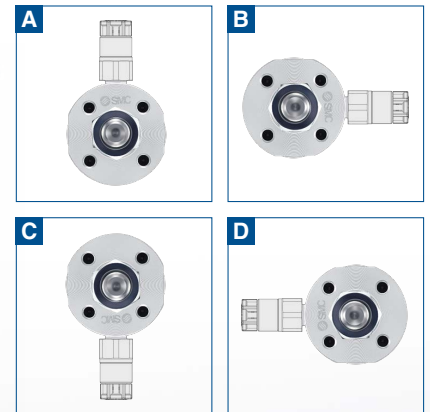

Cylinder with rod end bracket is standardized.



Interchangeable in mounting with the existing model



**CG1 Series**



CAT.ES20-268A

## Stroke Variations

Bore size	Standard stroke									Max. manufacturable stroke [mm]
	25	50	75	100	125	150	200	250	300	
20	●	●	●	●	●	●	●			1000
25	●	●	●	●	●	●	●	●	●	
32	●	●	●	●	●	●	●	●	●	
40	●	●	●	●	●	●	●	●	●	
50	●	●	●	●	●	●	●	●	●	
63	●	●	●	●	●	●	●	●	●	
80	●	●	●	●	●	●	●	●	●	
100	●	●	●	●	●	●	●	●	●	

## Series Variations \* For details about the clean series, refer to the Web Catalog.

Series	Action	Type	Cushion	Bore size [mm]								Variations			Page	
				20	25	32	40	50	63	80	100	With rod boot	Air-hydro	Clean series		
<b>New</b> Standard CG1-Z1	Double acting	Single rod	Rubber bumper	●	●	●	●	●	●	●	●					3
Standard CG1-Z	Double acting	Single rod	Rubber bumper	●	●	●	●	●	●	●	●	●	●	●		Web Catalog
			Air cushion	●	●	●	●	●	●	●	●	●	●			
	Double acting	Double rod	Rubber bumper	●	●	●	●	●	●	●	●	●	●	●	●	Web Catalog
Air cushion			●	●	●	●	●	●	●	●	●	●				
Single acting	Single rod (Spring return/extend)	Rubber bumper	●	●	●	●									Web Catalog	
Non-rotating rod CG1K-Z	Double acting	Single rod	Rubber bumper	●	●	●	●	●	●						Web Catalog	
			Air cushion				●	●	●							
Double acting	Double rod	Rubber bumper	●	●	●	●	●	●						Web Catalog		
Direct mount CG1R-Z	Double acting	Single rod	Rubber bumper	●	●	●	●	●	●					Web Catalog		
			Air cushion	●	●	●	●	●	●							
Direct mount, Non-rotating rod CG1KR-Z	Double acting	Single rod	Rubber bumper	●	●	●	●	●	●					Web Catalog		
With end lock CBG1	Double acting	Single rod	Rubber bumper	●	●	●	●	●	●	●	●	●		Web Catalog		
			Air cushion	●	●	●	●	●	●	●	●	●				
Smooth Cylinder CG1Y-Z	Double acting	Single rod	Rubber bumper	●	●	●	●	●	●	●	●			Web Catalog		
<b>CG3 series</b>																
Short type Standard CG3	Double acting	Single rod	Rubber bumper	●	●	●	●	●	●	●	●				Web Catalog	

## Various mounting bracket options

- Mounting brackets suitable for various installation conditions
- Improved mounting flexibility

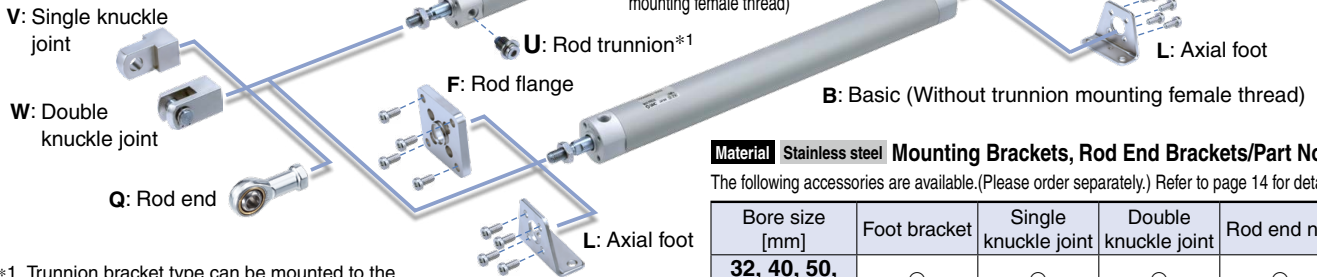

\*1 Trunnion bracket type can be mounted to the CG1□Z (with trunnion mounting female thread).

**Material** Stainless steel **Mounting Brackets, Rod End Brackets/Part Nos.**  
 The following accessories are available. (Please order separately.) Refer to page 14 for details.



Bore size [mm]	Foot bracket	Single knuckle joint	Double knuckle joint	Rod end nut
32, 40, 50, 63, 80, 100	○	○	○	○

## Part numbers for products with a rod end bracket and/or a pivot bracket

It is not necessary to order a bracket for the applicable cylinder separately.  
 \* Mounting brackets are shipped together with the product but do not come assembled.

Example) **CDG1** **D** **N20-50Z1-** **N** **W** **-M9BW**  
 • Mounting

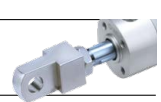
Pivot bracket	
Nil	No bracket
N	Pivot bracket 

Rod end bracket	
Nil	No bracket
V	Single knuckle joint 
W	Double knuckle joint 
Q	Rod end 

\* Applicable only to D, U, and T mounting types

## Environmentally Resistant Specifications

### Water Resistant ■ Corrosion Resistant

Stainless steel cylinder (CG5 Series) ..... **Web Catalog**

### Water Resistant

The use of a special scraper allows for improved water resistance.

Water-resistant cylinder (CG1□R/V)\*1 ..... **Web Catalog**

### Corrosion Resistant

Fluororubber seal (-XC22)\*1 ..... **Web Catalog**

### Dust Resistant

Durability is 4 times stronger than the standard model.

Compact cylinder with stable lubrication function (Lube-retainer) (CG1□M)\*1 ..... **Web Catalog**

Prevents dust, etc., adhered to the rod from entering the internal parts  
 With heavy duty scraper (-XC4) ..... p. 24

### Spatter Resistant

With coil scraper (-XC35) ..... p. 26

### Temperature Measures

Heat resistant/Cold resistant cylinder (-XB6, -XB7)\*1  
 ..... **Web Catalog**

Refer to "Operating Environment" in the Actuator Precautions.

\*1 The shape (type) is the same as the existing model.

## Applications Requiring Lateral Load Resistance

For use in applications in which a lateral load exceeding the allowable value is to be applied, consider using a guide cylinder.

## CONTENTS

How to Order	p. 3
Specifications	p. 4
Construction	p. 6
Dimensions	p. 7
Dimensions of Accessories	p. 13
Auto Switch Mounting	p. 15
Prior to Use Auto Switch Connections and Examples	p. 20
Simple Specials	
Change of Rod End Shape	p. 22

Made to Order Common Specifications	
Special Port Location	p. 24
With Heavy Duty Scraper	p. 24
Made of Stainless Steel	p. 24
Head Cover Axial Port	p. 25
Double Clevis and Double Knuckle Joint Pins Made of Stainless Steel	p. 25
Double Knuckle Joint with Spring Pin	p. 25
With Coil Scraper	p. 26
Grease for Food Processing Equipment	p. 26
PTFE Grease	p. 27
Interchangeable for Long Strokes for Existing Bore Size	p. 27

# Air Cylinder: Standard Type Double Acting, Single Rod

## CG1 Series

RoHS

ø20, ø25, ø32, ø40, ø50, ø63, ø80, ø100

### How to Order

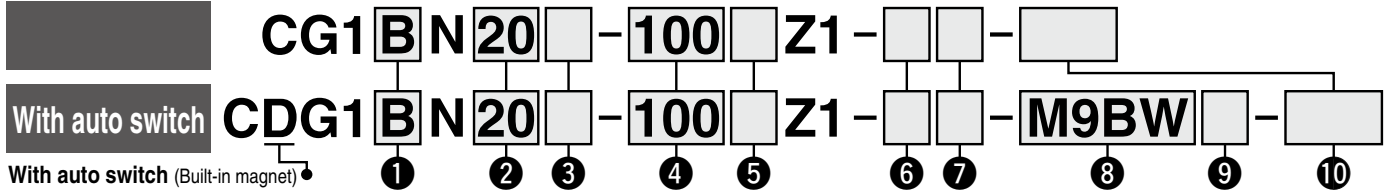

#### 1 Mounting

<b>B</b>	Basic (Without trunnion mounting female thread)
<b>Z*1</b>	Basic (With trunnion mounting female thread)
<b>L</b>	Axial foot
<b>F</b>	Rod flange
<b>G</b>	Head flange
<b>U*1</b>	Rod trunnion
<b>T*1</b>	Head trunnion
<b>D</b>	Clevis

- \*1 Not available for ø80 and ø100
- \* Mounting brackets are shipped together with the product but do not come assembled.
- \* The cylinder for L, F, G, and D mounting types is B: Basic (Without trunnion mounting female thread).

**The presence of the trunnion mounting female thread (B, Z) is different from the existing product. Choose Z (with trunnion mounting female thread) when mounting the trunnion afterward.**

#### 2 Bore size

<b>20</b>	20 mm
<b>25</b>	25 mm
<b>32</b>	32 mm
<b>40</b>	40 mm
<b>50</b>	50 mm
<b>63</b>	63 mm
<b>80</b>	80 mm
<b>100</b>	100 mm

#### 6 Pivot bracket

<b>Nil</b>	No bracket
<b>N</b>	Pivot bracket

- \* Only for D, U, and T mounting types
- \* The pivot bracket is shipped together with the product but does not come assembled.

#### 10 Made to order

For details ⇨ p. 4

#### 3 Port thread type

<b>Rubber bumper</b>		
<b>Nil</b>	Rc	ø20 to ø100
<b>TN</b>	NPT	ø20 to ø100
<b>TF</b>	M5 x 0.8	ø20, ø25
	G	ø32 to ø100

#### 7 Rod end bracket

<b>Nil</b>	No bracket
<b>V</b>	Single knuckle joint
<b>W</b>	Double knuckle joint
<b>Q</b>	Rod end

- \* No bracket is provided for the female rod end.
- \* The rod end bracket is shipped together with the product but does not come assembled.
- \* A knuckle joint pin is not provided with the single knuckle joint.

#### 4 Cylinder stroke [mm]

For standard strokes ⇨ p. 4

#### 5 Rod end thread

<b>Nil</b>	Male rod end
<b>F</b>	Female rod end

#### 8 Auto switch

<b>Nil</b>	Without auto switch
------------	---------------------

- \* For applicable auto switches, refer to the table below.

#### 9 Number of auto switches

<b>Nil</b>	2
<b>S</b>	1
<b>n</b>	n

For details on **auto switch mounting** ⇨ p. 15 to 19

- Auto Switch Proper Mounting Position (Detection at stroke end) and Mounting Height
- Minimum Stroke for Auto Switch Mounting · Auto Switch Mounting Brackets/Part Nos.
- Operating Range · Cylinder Mounting Bracket, by Stroke/Auto Switch Mounting Surfaces

\* For the ordering example of cylinder assembly ⇨ p. 5

### Applicable Auto Switches/Refer to the Web Catalog for further information on auto switches.

Type	Special function	Electrical entry	Indicator/light	Wiring (Output)	Load voltage		Auto switch model			Lead wire length [m]					Pre-wired connector	Applicable load			
					DC	AC	Applicable bore size			0.5 (Nil)	1 (M)	3 (L)	5 (Z)	None (N)					
							ø20 to ø63	ø80, ø100											
Solid state auto switch	—	Grommet	No	3-wire (NPN)	5 V, 12 V	—	Perpendicular	M9NV	M9N	G59	●	●	●	○	○	IC circuit			
								—	—	—	●	●	●	○	○				
				3-wire (PNP)			M9PV	M9P	G5P	●	●	●	○	○					
		2-wire		—			—	K59	●	—	●	○	○						
		Connector		—			—	H7C	●	—	●	○	○						
		—		—			—	—	●	—	●	○	○						
	Diagnostic indication (2-color indicator)	Grommet	Yes	3-wire (NPN)	24 V	5 V, 12 V	—	In-line	M9NWV	M9NW	G59W	●	●	●	○	○	IC circuit		
									—	—	—	●	●	●	○	○			
				3-wire (PNP)				M9PWV	M9PW	G5PW	●	●	●	○	○				
		2-wire		—				—	G5PW	●	—	●	○	○					
		Connector		—				—	—	●	—	●	○	○					
		—		—				—	—	●	—	●	○	○					
Water resistant (2-color indicator)	Grommet	No	3-wire (NPN)	5 V, 12 V	—	—	In-line	M9NAV*1	M9NA*1	—	○	○	●	○	○	IC circuit			
								—	—	—	○	○	●	○	○				
			3-wire (PNP)				M9PAV*1	M9PA*1	—	○	○	●	○	○					
	2-wire		—				—	—	○	○	●	○	○						
	Connector		—				—	—	○	○	●	○	○						
	—		—				—	—	○	○	●	○	○						
Reed auto switch	—	Grommet	Yes	3-wire (Equiv. to NPN)	24 V	12 V	—	A96V	A96	G59F	●	—	●	—	—	IC circuit			
								—	—	—	●	—	●	—	—				
				100 V			A93V*2	A93	—	●	●	●	—	—					
		100 V or less		A90V			A90	—	●	—	●	—	—						
		100 V, 200 V		—			—	B54	●	—	●	—	—						
	Diagnostic indication (2-color indicator)	Grommet		No			2-wire	24 V	24 V or less	—	—	—	B64	—	●	—	●	—	—
												—	—	—	●	—	●	—	
							Connector				—	—	C73C	—	●	—	●	—	
		—					—				—	C80C	—	●	—	●	—		
		Grommet					—				—	—	—	●	—	●	—		

- \*1 Water-resistant type auto switches can be mounted on the above models, but SMC cannot guarantee water resistance. A water-resistant type cylinder is recommended for use in an environment which requires water resistance. However, please contact SMC for water-resistant cylinder of ø20 and ø25.
- \*2 The 1 m lead wire is only applicable to the D-A93.
- \* Lead wire length symbols: 0.5 m..... Nil (Example) M9NW 5 m..... Z (Example) M9NWZ 1 m..... M (Example) M9NWM None..... N (Example) H7CN 3 m..... L (Example) M9NWL
- \* Solid state auto switches marked with "○" are produced upon receipt of order.
- \* There are applicable auto switches other than those listed above. For details ⇨ p. 19
- \* For details on auto switches with pre-wired connectors ⇨ Refer to the Web Catalog.
- \* The D-A9□□/M9□□□ auto switches are shipped together with the product but do not come assembled. (Only the auto switch mounting brackets are assembled before shipment.)





### Symbol

Rubber bumper

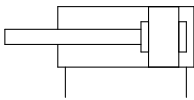

**Made to Order Common Specifications**  
(For details ⇨ p. 21 to 27)

Symbol	Specifications
-XA□	Change of rod end shape
-XC3	Special port location
-XC4	With heavy duty scraper
-XC6	Made of stainless steel
-XC20	Head cover axial port
-XC27	Double clevis and double knuckle joint pins made of stainless steel
-XC29	Double knuckle joint with spring pin
-XC35	With coil scraper
-XC85	Grease for food processing equipment
-X446	PTFE grease
-X3252	Interchangeable for long strokes for existing bore size

## Specifications

Bore size [mm]	20	25	32	40	50	63	80	100	
<b>Action</b>	Double acting, Single rod								
<b>Lubricant</b>	Not required (Non-lube)								
<b>Fluid</b>	Air								
<b>Proof pressure</b>	1.5 MPa								
<b>Maximum operating pressure</b>	1.0 MPa								
<b>Minimum operating pressure</b>	0.05 MPa								
<b>Ambient and fluid temperatures</b>	Without auto switch: -10°C to 70°C With auto switch : -10°C to 60°C (No freezing)								
<b>Piston speed</b>	50 to 1000 mm/s						50 to 700 mm/s		
<b>Stroke length tolerance*1</b>	Up to 1000 st <sup>+1.4</sup> <sub>0</sub> mm								
<b>Cushion</b>	Rubber bumper								
<b>Mounting*2</b>	Basic (Without trunnion mounting female thread), Basic (With trunnion mounting female thread), Axial foot, Rod flange, Head flange, Rod trunnion, Head trunnion, Clevis								
<b>Allowable kinetic energy [J]</b>	<b>Male rod end</b>	0.28	0.41	0.66	1.20	2.00	3.40	5.90	9.90
	<b>Female rod end</b>	0.11	0.18	0.29	0.52	0.91	1.54	2.71	4.54

\*1 Does not include the amount of bumper change

\*2 Cylinder sizes ø80 and ø100 do not have basic (with trunnion mounting female thread), rod trunnion, and head trunnion types. Foot, flange, and clevis types of cylinder sizes from ø20 to ø63 do not have trunnion mounting female thread. Operate the cylinder within the allowable kinetic energy.

\* For the allowable rod end lateral load, refer to the "Air Cylinders Model Selection" in the **Web Catalog**.

## Accessories/For part numbers and dimensions ⇨ p. 13, 14

Mounting		Basic	Axial foot	Rod flange	Head flange	Rod trunnion	Head trunnion	Clevis
Standard	Rod end nut*3	●	●	●	●	●	●	●
	Clevis pin*3	—	—	—	—	—	—	●
Option	Single knuckle joint*3	●	●	●	●	●	●	●
	Double knuckle joint (with pin)*2, *3	●	●	●	●	●	●	●
	Rod end	●	●	●	●	●	●	●
	Pivot bracket*1	—	—	—	—	●*1	●*1	●
	Rod boot	●	●	●	●	●	●	●

\*1 Not available for ø80 and ø100

\*2 A double knuckle joint pin and retaining rings are shipped together with the product.

\*3 Stainless steel mounting brackets and accessories are also available.

For details ⇨ p. 14

## Standard Strokes

Bore size	Standard stroke*1	Manufacturable stroke
20	25, 50, 75, 100, 125, 150, 200	1 to 1000
25	25, 50, 75, 100, 125, 150, 200, 250, 300	1 to 1000
32		
40		
50, 63		
80		
100		

\*1 Intermediate strokes not listed above are produced upon receipt of order. The manufacturing of intermediate strokes in 1 mm increments is possible. (Spacers are not used.)

\* Applicable strokes should be confirmed according to the usage. For details, refer to the "Air Cylinders Model Selection" in the **Web Catalog**. In addition, the products that exceed the standard stroke might not be able to fulfill the specifications due to deflection, etc.

## ⚠ Precautions

Refer to page 28 before handling.

# CG1 Series

## Ordering Example of Cylinder Assembly

Cylinder model: CDG1DN20-100Z1-NW-M9BW

Mounting D: Clevis  
 Pivot bracket N: Yes  
 Rod end bracket W: Double knuckle joint  
 Auto switch D-M9BW: 2 pcs.

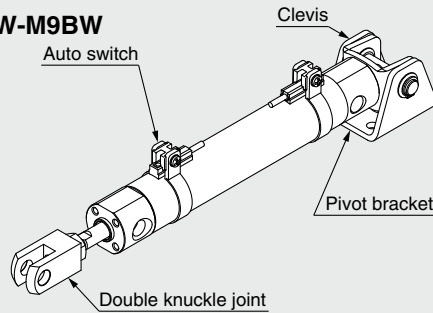

\* Pivot bracket, double knuckle joint, and auto switch are shipped together with the product but do not come assembled.

## Mounting Brackets/Part Nos.

Mounting bracket	Order qty.	Bore size [mm]								Contents
		20	25	32	40	50	63	80	100	
Axial foot	2*1	CG-L020	CG-L025	CG-L032	CG-L040	CG-L050	CG-L063	CG-L080	CG-L100	2 foot brackets, 8 mounting bolts
Flange	1	CG-F020	CG-F025	CG-F032	CG-F040	CG-F050	CG-F063	CG-F080	CG-F100	1 flange, 4 mounting bolts
Trunnion pin	1	CG-T020	CG-T025	CG-T032	CG-T040	CG-T050	CG-T063	—	—	2 trunnion pins, 2 trunnion bolts, 2 flat washers
Clevis	1	CG-D020	CG-D025	CG-D032	CG-D040	CG-D050	CG-D063	CG-D080	CG-D100	1 clevis, 4 mounting bolts, 1 clevis pin, 2 retaining rings
Pivot bracket	1	CG-020-24A	CG-025-24A	CG-032-24A	CG-040-24A	CG-050-24A	CG-063-24A	CG-080-24A	CG-100-24A	1 pivot bracket

\*1 Order two foot brackets per cylinder.

\* Stainless steel mounting brackets and accessories are also available. For details ⇨ p. 14

## Mounting Brackets, Accessories/Material, Surface Treatment

Segment	Description	Material	Surface treatment
Mounting brackets	Foot	Carbon steel	Nickel plating
	Flange	Carbon steel (ø20 to ø63)	Nickel plating
		Cast iron (ø80, ø100)	Nickel plating
	Clevis	Carbon steel (ø20 to ø63)	Nickel plating
		Cast iron (ø80, ø100)	Nickel plating
	Trunnion pin	Trunnion pin	Carbon steel
Trunnion bolt		Carbon steel	Nickel plating
Flat washer		Carbon steel	Nickel plating
Accessories	Rod end nut	Carbon steel	Zinc chromating
	Single knuckle joint	Carbon steel (ø20 to ø32)	Nickel plating
		Cast iron (ø40 to ø100)	Zinc chromating
	Double knuckle joint	Carbon steel (ø20 to ø32)	Nickel plating
		Cast iron (ø40 to ø100)	Zinc chromating
	Rod end	Carbon steel	Zinc plating
	Knuckle pin	Carbon steel	—
	Clevis pin	Carbon steel	—
	Pivot bracket	Carbon steel (ø20 to ø63)	Nickel plating
		Cast iron (ø80, ø100)	Nickel plating
Mounting bolt	Carbon steel	Nickel plating	
Retaining ring	Carbon tool steel	Phosphate coating	

## Mounting Procedure

### Mounting procedure for trunnion

Follow the procedures below when mounting a pivot bracket on the trunnion.

ø20 to ø63

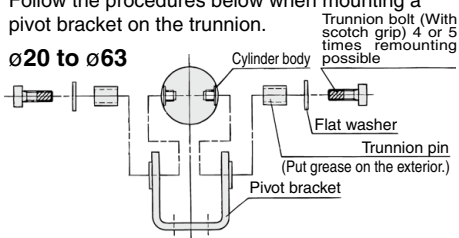

### Mounting procedure for clevis

Follow the procedures below when mounting a pivot bracket on the clevis.

ø20 to ø63

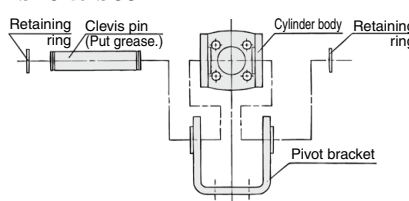

ø80, ø100

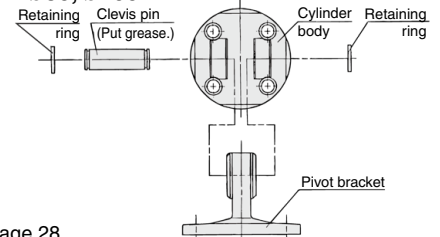

For the proper tightening torque of the trunnion and clevis ⇨ Refer to the Specific Product Precautions on page 28.

## Weight

Bore size [mm]		20	25	32	40	50	63	80	100
Basic weight	Basic: Without trunnion mounting female thread (B)	0.11	0.17	0.25	0.45	0.80	1.09	2.07	3.16
	Basic: With trunnion mounting female thread (Z)	0.11	0.17	0.24	0.44	0.79	1.06	—	—
	Axial foot	0.21	0.29	0.40	0.67	1.26	1.77	3.04	4.91
	Flange	0.18	0.26	0.38	0.65	1.16	1.64	2.78	4.44
	Trunnion	0.12	0.19	0.28	0.49	0.88	1.20	—	—
	Clevis	0.17	0.25	0.39	0.68	1.19	1.78	2.77	4.44
	Pivot bracket	0.08	0.09	0.17	0.25	0.44	0.80	0.98	1.75
	Single knuckle joint	0.05	0.09	0.09	0.10	0.22	0.22	0.39	0.57
	Double knuckle joint (with pin)	0.05	0.09	0.09	0.13	0.26	0.26	0.64	1.31
	Rod end	0.05	0.07	0.07	0.16	0.30	0.30	0.49	0.67
	Additional weight per 50 mm of stroke	0.05	0.07	0.09	0.14	0.21	0.25	0.35	0.50
	Additional weight for switch magnet	0.01	0.01	0.01	0.01	0.01	0.02	0.02	0.04
	Weight reduction for female rod end	-0.01	-0.02	-0.02	-0.05	-0.10	-0.10	-0.19	-0.27

Calculation (Example): **CDG1FN20-100Z1**  
 (Built-in magnet, Flange, ø20, 100 mm stroke)

- Basic weight.....0.18 kg (Flange, ø20)
  - Additional weight for stroke.....0.05 kg/50 mm
  - Air cylinder stroke .....100 mm
  - Additional weight for switch magnet.....0.01 kg
- $0.18 + 0.05 \times (100/50) + 0.01 = 0.29$  kg

## Construction

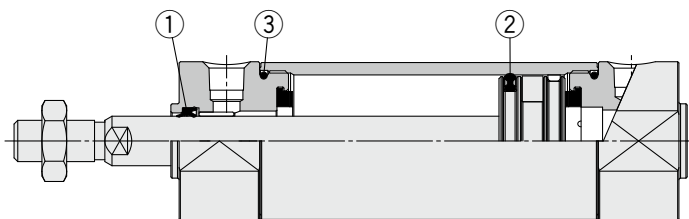

### Component Parts

No.	Description	Material
1	Rod seal	NBR
2	Piston seal	NBR
3	Tube gasket	NBR

### Replacement Parts: Seal Kit

Bore size [mm]	Kit no.	Contents
20	CG1N20Z-PS	Set of nos. ①, ②, ③
25	CG1N25Z-PS	
32	CG1N32Z-PS	
40	CG1N40Z-PS	

- \* As sizes ø50 and larger cannot be disassembled, the seal cannot be replaced.
- \* For disassembly/replacement ⇨ Refer to the Specific Product Precautions on page 28. Order with the kit number according to the bore size.
- \* The seal kit includes a grease pack (10 g). Order with the following part number when only the grease pack is needed.  
**Grease pack part number: GR-S-010 (10 g)**

# CG1 Series

## Dimensions: Basic

### Without trunnion mounting female thread/C□G1B

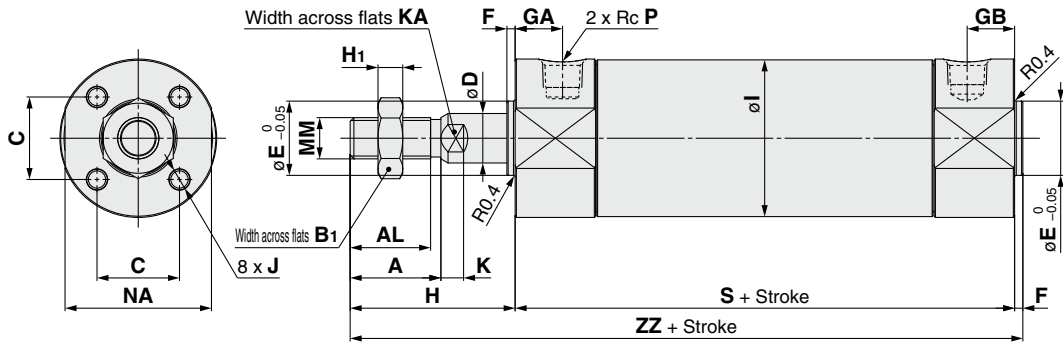

### With trunnion mounting female thread/C□G1Z

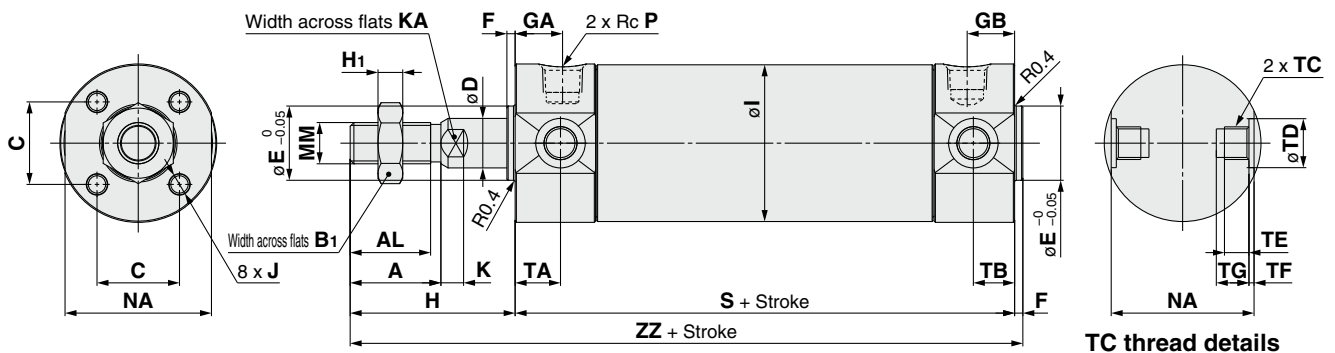

### Female rod end

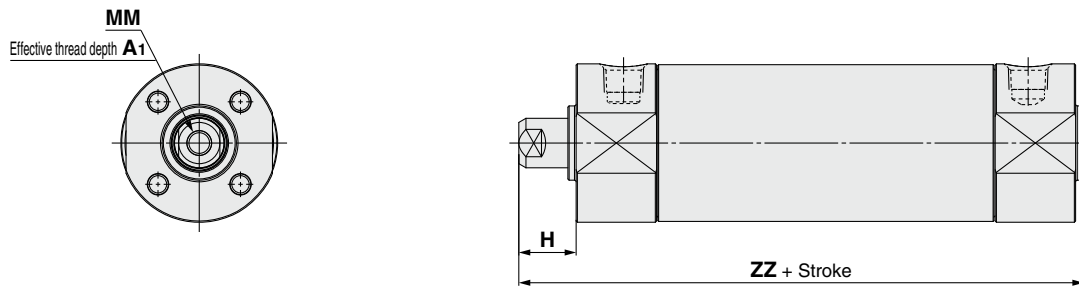

Bore size	A	AL	B <sub>1</sub>	C	D	E	F	H	H <sub>1</sub>	I	J	K	KA	MM	NA	S	TA	TB	ZZ
20	18	15.5	13	14	8	12	2	35	5	26	M4 x 0.7 depth 7	5	6	M8 x 1.25	24	69	11	11	106
25	22	19.5	17	16.5	10	14	2	40	6	31	M5 x 0.8 depth 7.5	5.5	8	M10 x 1.25	29	69	11	11	111
32	22	19.5	17	20	12	18	2	40	6	38	M5 x 0.8 depth 8	5.5	10	M10 x 1.25	35.5	71	11	10	113
40	30	27	19	26	16	25	2	50	8	47	M6 x 1 depth 12	6	14	M14 x 1.5	44	78	12	10	130
50	35	32	27	32	20	30	2	58	11	58	M8 x 1.25 depth 16	7	18	M18 x 1.5	55	90	13	12	150
63	35	32	27	38	20	32	2	58	11	72	M10 x 1.5 depth 16	7	18	M18 x 1.5	69	90	13	12	150
80	40	37	32	50	25	40	3	71	13	89	M10 x 1.5 depth 22	10	22	M22 x 1.5	86	108	—	—	182
100	40	37	41	60	30	50	3	71	16	110	M12 x 1.75 depth 22	10	26	M26 x 1.5	106	108	—	—	182

Bore size	Rc, NPT port			G port		
	GA	GB	P	GA	GB	P
20	11.5	11.5	1/8	11.5	11.5	M5 x 0.8
25	11.5	11.5	1/8	12	12	M5 x 0.8
32	11.5	11.5	1/8	10.5	10.5	1/8
40	13	13	1/8	13	13	1/8
50	14	14	1/4	14	14	1/4
63	14	14	1/4	14	14	1/4
80	20	16	3/8	20	16	3/8
100	16	16	1/2	16	16	1/2

Bore size	A <sub>1</sub>	H	MM	ZZ
20	8	13	M4 x 0.7	84
25	8	14	M5 x 0.8	85
32	12	14	M6 x 1	87
40	13	15	M8 x 1.25	95
50	18	16	M10 x 1.5	108
63	18	16	M10 x 1.5	108
80	21	19	M14 x 1.5	130
100	25	22	M16 x 1.5	133

Bore size	TC	TD	TE	TF	TG
20	M5 x 0.8	8 <sup>+0.08</sup> <sub>0</sub>	4	0.5	5.5
25	M6 x 0.75	10 <sup>+0.08</sup> <sub>0</sub>	5	1	6.5
32	M8 x 1.0	12 <sup>+0.08</sup> <sub>0</sub>	5.5	1	7.5
40	M10 x 1.25	14 <sup>+0.08</sup> <sub>0</sub>	6	1.25	8.5
50	M12 x 1.25	16 <sup>+0.08</sup> <sub>0</sub>	7.5	2	10
63	M14 x 1.5	18 <sup>+0.08</sup> <sub>0</sub>	11.5	3	14.5
80	—	—	—	—	—
100	—	—	—	—	—

\* Cylinder sizes ø80 and ø100 do not have trunnion mounting female thread on the width across flats NA.



**Dimensions: Axial Foot**

C□G1L

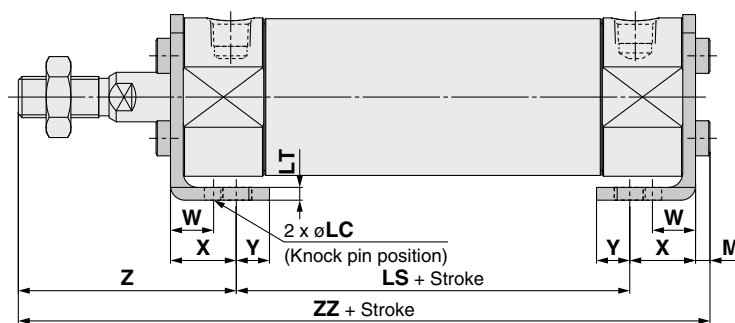
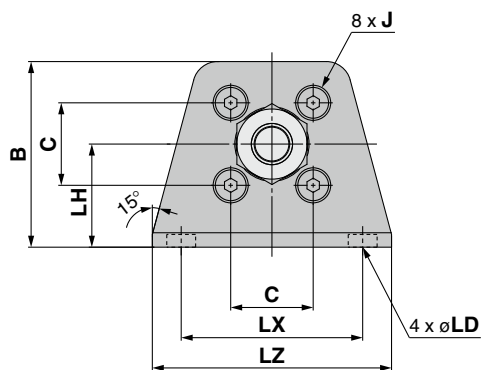

**Female rod end**

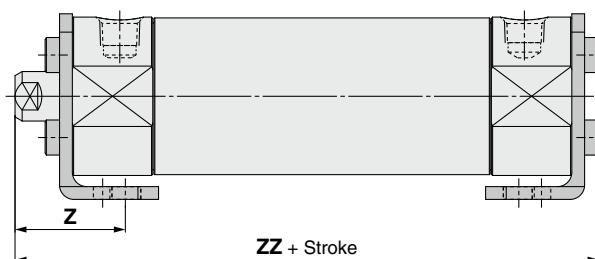

\* Stainless steel mounting brackets and accessories are also available. For details ⇨ p. 14

Bore size	B	C	J	LC	LD	LH	LS	LT	LX	LZ	M	W	X	Y	Z	ZZ
20	34	14	M4 x 0.7	4	6	20	45	3	32	44	3	10	15	7	47	110
25	38.5	16.5	M5 x 0.8	4	6	22	45	3	36	49	3.5	10	15	7	52	115.5
32	45	20	M5 x 0.8	4	7	25	45	3	44	58	3.5	10	16	8	53	117.5
40	54.5	26	M6 x 1	4	7	30	51	3	54	71	4	10	16.5	8.5	63.5	135
50	70.5	32	M8 x 1.25	5	10	40	55	4.5	66	86	5	17.5	22	11	75.5	157.5
63	82.5	38	M10 x 1.5	5	12	45	55	4.5	82	106	5	17.5	22	13	75.5	157.5
80	101	50	M10 x 1.5	6	11	55	60	4.5	100	125	5	20	28.5	14	95	188.5
100	121	60	M12 x 1.75	6	14	65	60	6	120	150	7	20	30	16	95	192

**Female Rod End** [mm]

Bore size	Z	ZZ
20	25	88
25	26	89.5
32	27	91.5
40	28.5	100
50	33.5	115.5
63	33.5	115.5
80	43	136.5
100	46	143

# CG1 Series

## Dimensions: Flange

### Rod flange/C□G1F

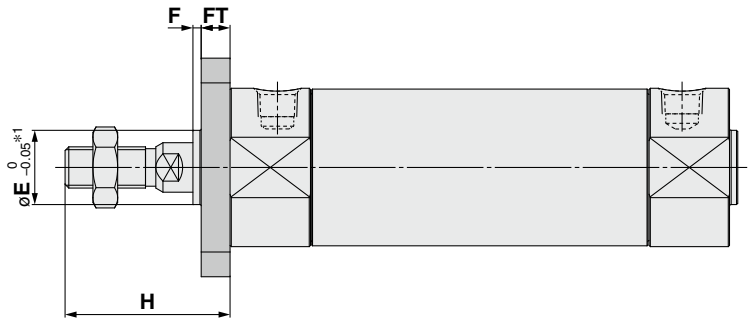
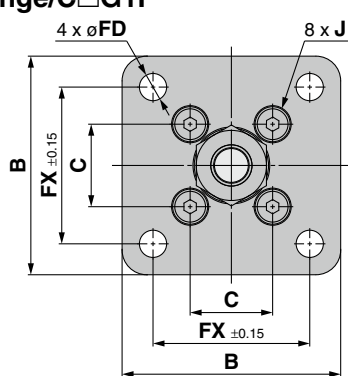

\*1 End boss is machined on the flange for øE.

### Female rod end

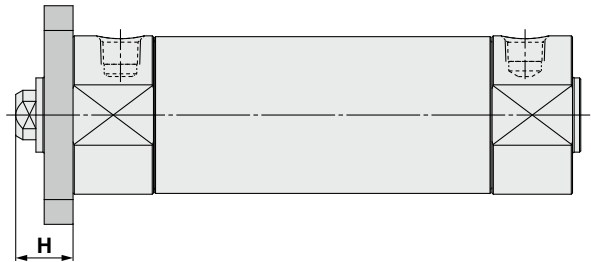

Bore size	B	C	E	F	FD	FT	FX	H	J
20	40	14	12	2	5.5	6	28	35	M4 x 0.7
25	44	16.5	14	2	5.5	7	32	40	M5 x 0.8
32	53	20	18	2	6.6	7	38	40	M5 x 0.8
40	61	26	25	2	6.6	8	46	50	M6 x 1
50	76	32	30	2	9	9	58	58	M8 x 1.25
63	92	38	32	2	11	9	70	58	M10 x 1.5
80	104	50	40	3	11	11	82	71	M10 x 1.5
100	128	60	50	3	14	14	100	71	M12 x 1.75

Bore size	H
20	13
25	14
32	14
40	15
50	16
63	16
80	19
100	22

### Head flange/C□G1G

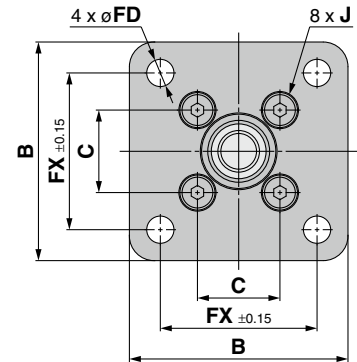
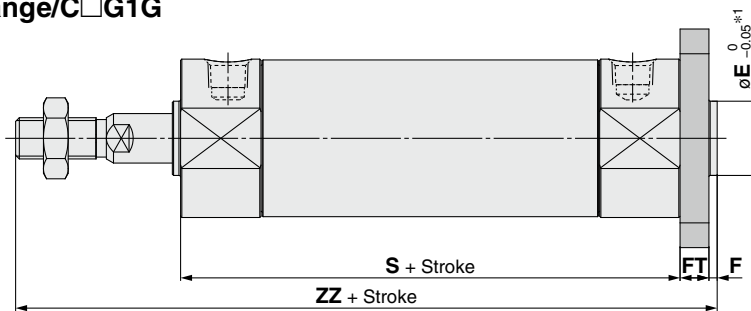

\*1 End boss is machined on the flange for øE.

### Female rod end

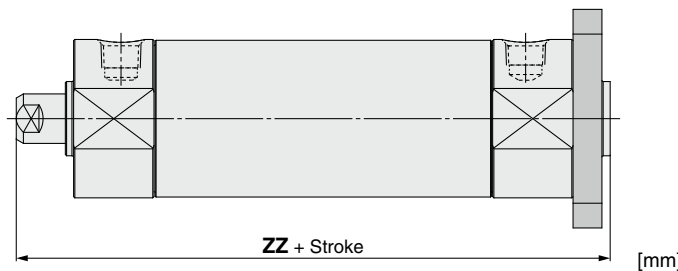

Bore size	B	C	E	F	FD	FT	FX	J	S	ZZ
20	40	14	12	2	5.5	6	28	M4 x 0.7	69	112
25	44	16.5	14	2	5.5	7	32	M5 x 0.8	69	118
32	53	20	18	2	6.6	7	38	M5 x 0.8	71	120
40	61	26	25	2	6.6	8	46	M6 x 1	78	138
50	76	32	30	2	9	9	58	M8 x 1.25	90	159
63	92	38	32	2	11	9	70	M10 x 1.5	90	159
80	104	50	40	3	11	11	82	M10 x 1.5	108	193
100	128	60	50	3	14	14	100	M12 x 1.75	108	196

Bore size	ZZ
20	90
25	92
32	94
40	103
50	117
63	117
80	141
100	147

## Dimensions: Trunnion

### Rod trunnion/C□G1U

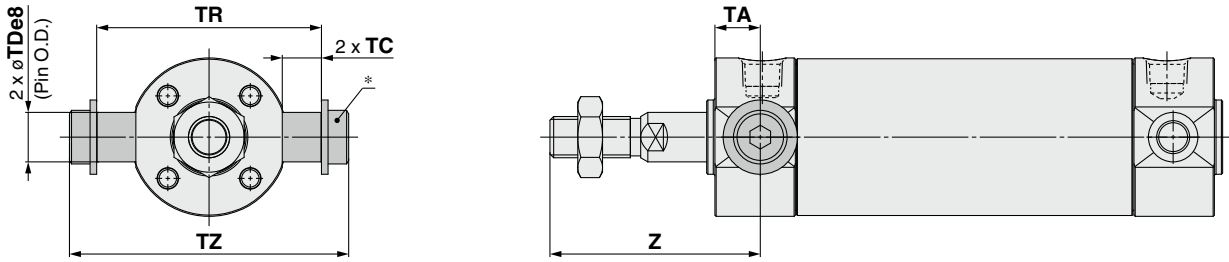

The part marked with an asterisk (\*) is constructed of a trunnion pin, flat washer, and hexagon socket head cap screw.

### Female rod end

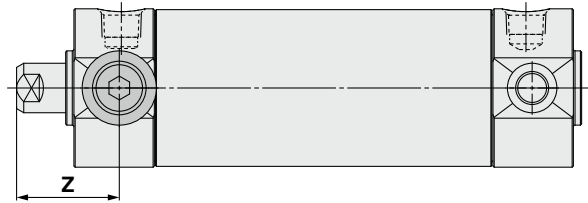

Bore size	TA	TC	TDe8	TR	TZ	Z
20	11	8	8 <sup>-0.025</sup> <sub>-0.047</sub>	39	47.6	46
25	11	8	10 <sup>-0.025</sup> <sub>-0.047</sub>	43	53	51
32	11	10.5	12 <sup>-0.032</sup> <sub>-0.059</sub>	54.5	67.7	51
40	12	12	14 <sup>-0.032</sup> <sub>-0.059</sub>	65.5	78.7	62
50	13	14.5	16 <sup>-0.032</sup> <sub>-0.059</sub>	80	98.6	71
63	13	17.5	18 <sup>-0.032</sup> <sub>-0.059</sub>	98	119.2	71

Bore size	Z
20	24
25	25
32	25
40	27
50	29
63	29

### Head trunnion/C□G1T

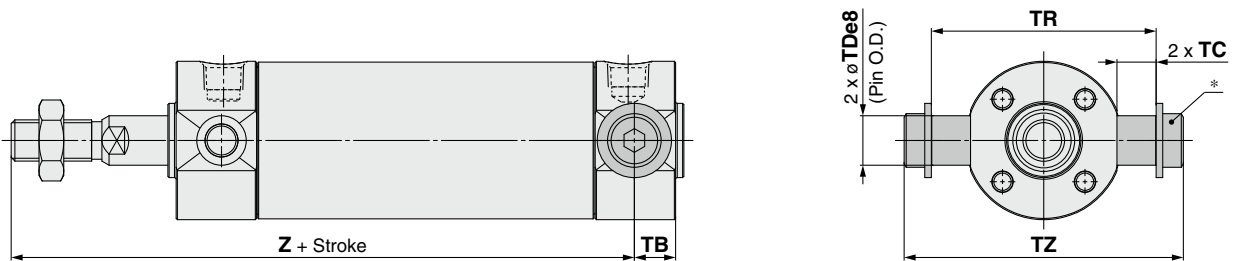

The part marked with an asterisk (\*) is constructed of a trunnion pin, flat washer, and hexagon socket head cap screw.

### Female rod end

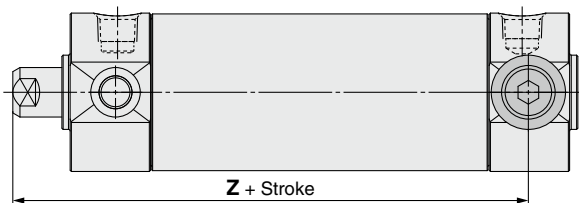

Bore size	TB	TC	TDe8	TR	TZ	Z
20	11	8	8 <sup>-0.025</sup> <sub>-0.047</sub>	39	47.6	93
25	11	8	10 <sup>-0.025</sup> <sub>-0.047</sub>	43	53	98
32	10	10.5	12 <sup>-0.032</sup> <sub>-0.059</sub>	54.5	67.7	101
40	10	12	14 <sup>-0.032</sup> <sub>-0.059</sub>	65.5	78.7	118
50	12	14.5	16 <sup>-0.032</sup> <sub>-0.059</sub>	80	98.6	136
63	12	17.5	18 <sup>-0.032</sup> <sub>-0.059</sub>	98	119.2	136

Bore size	Z
20	71
25	72
32	75
40	83
50	94
63	94

# CG1 Series

## Dimensions: Clevis

### C□G1D (ø20 to ø63)

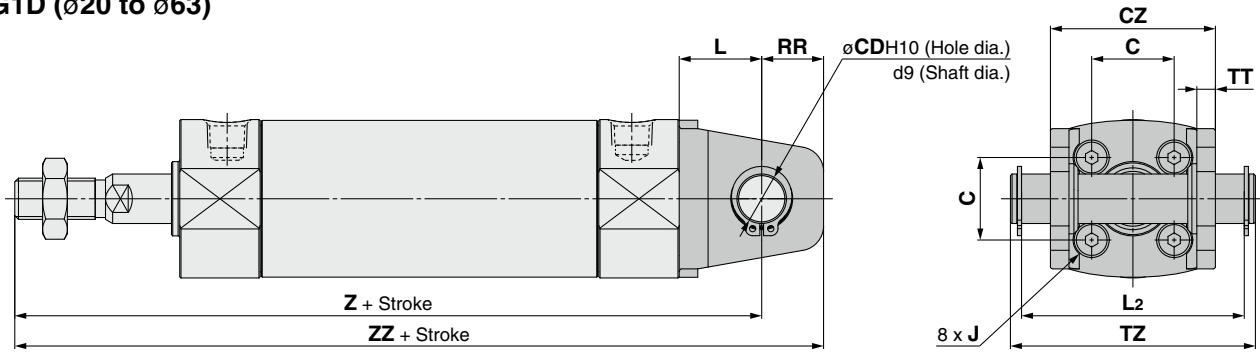

#### Female rod end

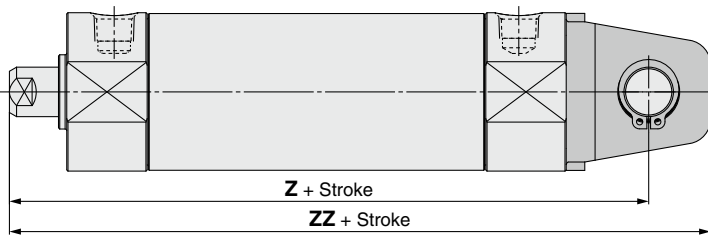

Bore size	C	CD	CZ	J	L	L <sub>2</sub>	RR	TT	TZ	Z	ZZ
20	14	8	29	M4 x 0.7	14	38.6	11	3.2	43.4	118	129
25	16.5	10	33	M5 x 0.8	16	42.6	13	3.2	48	125	138
32	20	12	40	M5 x 0.8	20	54	15	4.5	59.4	131	146
40	26	14	49	M6 x 1	22	65	18	4.5	71.4	150	168
50	32	16	60	M8 x 1.25	25	79.6	20	6	86	173	193
63	38	18	74	M10 x 1.5	30	97.8	22	8	105.4	178	200

Bore size	Z	ZZ
20	96	107
25	99	112
32	105	120
40	115	133
50	131	151
63	136	158

### C□G1D (ø80, ø100)

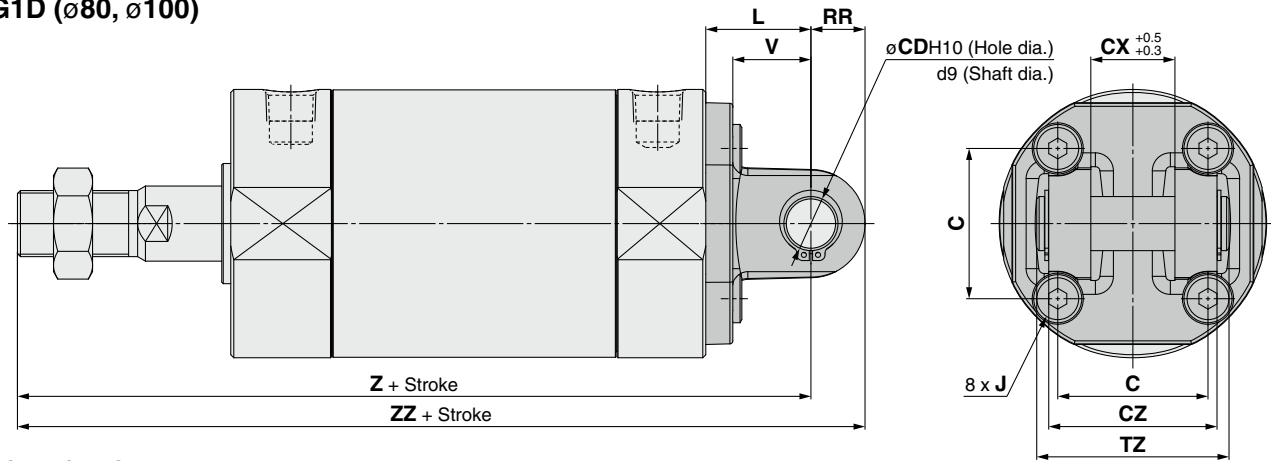

#### Female rod end

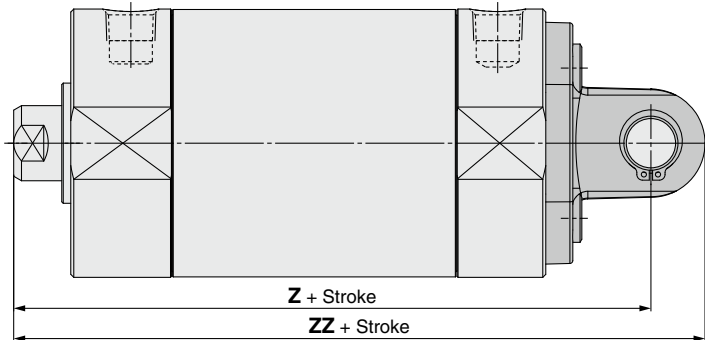

Bore size	C	CD	CX	CZ	J	L	RR	TZ	V	Z	ZZ
80	50	18	28	56	M10 x 1.5	35	18	64	26	214	232
100	60	22	32	64	M12 x 1.75	43	22	72	32	222	244

Bore size	Z	ZZ
80	162	180
100	173	195

## With Pivot Bracket

### Rod Trunnion (U) with Pivot Bracket

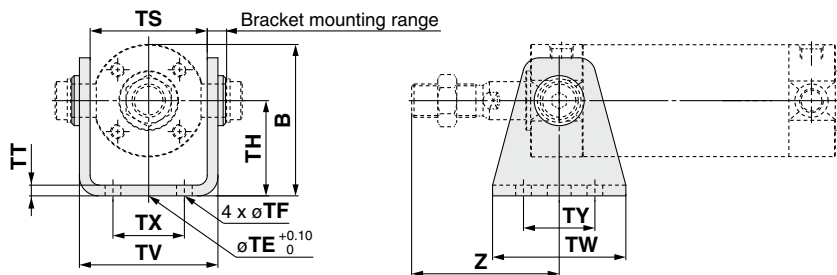

#### Male Thread

Bore size	B	TE	TF	TH	TS	TT	TV	TW	TX	TY	Z
20	38	10	5.5	25	28	3.2	35.8	42	16	28	46
25	45.5	10	5.5	30	33	3.2	39.8	42	20	28	51
32	54	10	6.6	35	40	4.5	49.4	48	22	28	51
40	63.5	10	6.6	40	49	4.5	58.4	56	30	30	62
50	79	20	9	50	60	6	72.4	64	36	36	71
63	96	20	11	60	74	8	90.4	74	46	46	71

#### Female Thread [mm]

Bore size	Z
20	24
25	25
32	25
40	27
50	29
63	29

### Head Trunnion (T) with Pivot Bracket

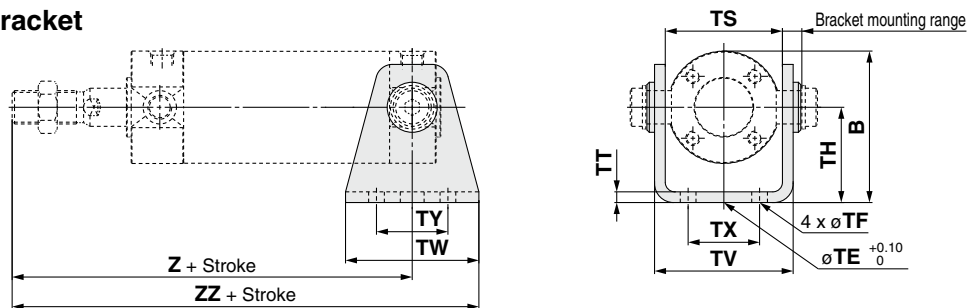

#### Male Thread

Bore size	B	TE	TF	TH	TS	TT	TV	TW	TX	TY	Z	ZZ
20	38	10	5.5	25	28	3.2	35.8	42	16	28	93	114
25	45.5	10	5.5	30	33	3.2	39.8	42	20	28	98	119
32	54	10	6.6	35	40	4.5	49.4	48	22	28	101	125
40	63.5	10	6.6	40	49	4.5	58.4	56	30	30	118	146
50	79	20	9	50	60	6	72.4	64	36	36	136	168
63	96	20	11	60	74	8	90.4	74	46	46	136	173

#### Female Thread [mm]

Bore size	Z	ZZ
20	71	92
25	72	93
32	75	99
40	83	111
50	94	126
63	94	131

### Clevis (D) with Pivot Bracket

ø20 to ø63

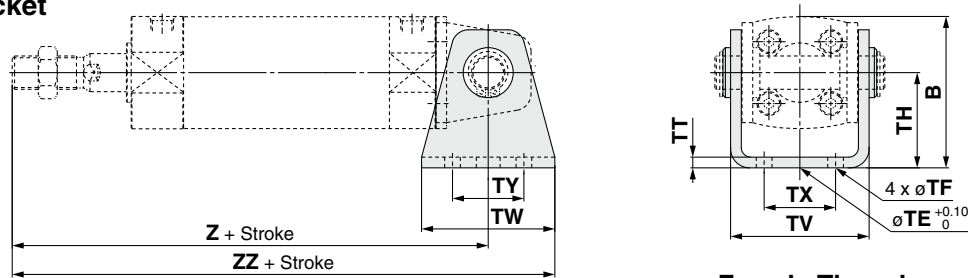

#### Male Thread

Bore size	B	TE	TF	TH	TT	TV	TW	TX	TY	Z	ZZ
20	38	10	5.5	25	3.2	35.8	42	16	28	118	139
25	45.5	10	5.5	30	3.2	39.8	42	20	28	125	146
32	54	10	6.6	35	4.5	49.4	48	22	28	131	155
40	63.5	10	6.6	40	4.5	58.4	56	30	30	150	178
50	79	20	9	50	6	72.4	64	36	36	173	205
63	96	20	11	60	8	90.4	74	46	46	178	215

#### Female Thread [mm]

Bore size	Z	ZZ
20	96	117
25	99	120
32	105	129
40	115	143
50	131	163
63	136	173

### Clevis (D) with Pivot Bracket

ø80, ø100

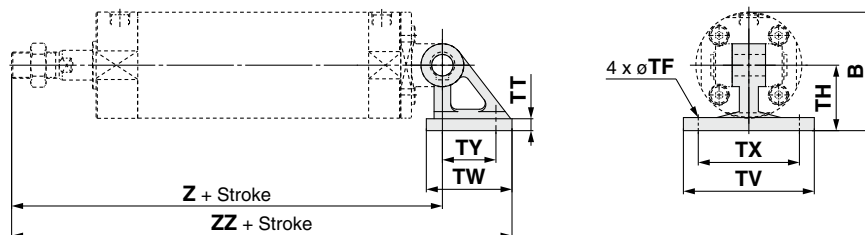

#### Male Thread

Bore size	B	TF	TH	TT	TV	TW	TX	TY	Z	ZZ
80	99.5	11	55	11	110	72	85	45	214	272.5
100	120	13.5	65	12	130	93	100	60	222	298.5

#### Female Thread [mm]

Bore size	Z	ZZ
80	162	220.5
100	173	249.5



# CG1 Series

## Dimensions of Accessories

### Single Knuckle Joint

#### I-G02, G03

Material: Carbon steel

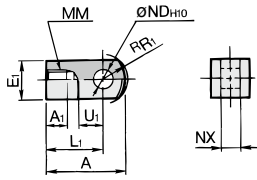

#### I-G04, G05, G08, G10

Material: Cast iron

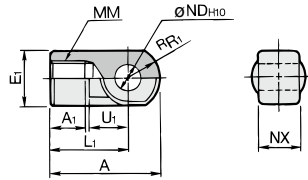

[mm]

Part no.	Applicable bore size [mm]	A	A <sub>1</sub>	E <sub>1</sub>	L <sub>1</sub>	MM	R <sub>1</sub>	U <sub>1</sub>	ND <sub>H10</sub>	NX
I-G02	20	34	8.5	□16	25	M8 x 1.25	10.3	11.5	8 <sup>+0.058</sup> <sub>0</sub>	8 <sup>-0.2</sup> <sub>-0.4</sub>
I-G03	25, 32	41	10.5	□20	30	M10 x 1.25	12.8	14	10 <sup>+0.058</sup> <sub>0</sub>	10 <sup>-0.2</sup> <sub>-0.4</sub>
I-G04	40	42	14	∅22	30	M14 x 1.5	12	14	10 <sup>+0.058</sup> <sub>0</sub>	18 <sup>-0.3</sup> <sub>-0.5</sub>
I-G05	50, 63	56	18	∅28	40	M18 x 1.5	16	20	14 <sup>+0.070</sup> <sub>0</sub>	22 <sup>-0.3</sup> <sub>-0.5</sub>
I-G08	80	71	21	∅38	50	M22 x 1.5	21	27	18 <sup>+0.070</sup> <sub>0</sub>	28 <sup>-0.3</sup> <sub>-0.5</sub>
I-G10	100	79	21	∅44	55	M26 x 1.5	24	31	22 <sup>+0.084</sup> <sub>0</sub>	32 <sup>-0.3</sup> <sub>-0.5</sub>

### Knuckle Pin

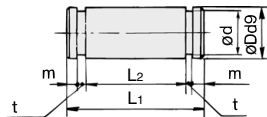

Material: Carbon steel

[mm]

Part no.	Applicable bore size [mm]	D <sub>d9</sub>	L <sub>1</sub>	d	L <sub>2</sub>	m	t	Included retaining ring
IY-G02	20	8 <sup>-0.040</sup> <sub>-0.076</sub>	21	7.6	16.2	1.5	0.9	Type C8 for axis
IY-G03	25, 32	10 <sup>-0.040</sup> <sub>-0.076</sub>	25.6	9.6	20.2	1.55	1.15	Type C10 for axis
IY-G04	40	10 <sup>-0.040</sup> <sub>-0.076</sub>	41.6	9.6	36.2	1.55	1.15	Type C10 for axis
IY-G05	50, 63	14 <sup>-0.050</sup> <sub>-0.093</sub>	50.6	13.4	44.2	2.05	1.15	Type C14 for axis
IY-G08	80	18 <sup>-0.050</sup> <sub>-0.093</sub>	64	17	56.2	2.55	1.35	Type C18 for axis
IY-G10	100	22 <sup>-0.065</sup> <sub>-0.117</sub>	72	21	64.2	2.55	1.35	Type C22 for axis

\* Retaining rings are included.

### Clevis Pin

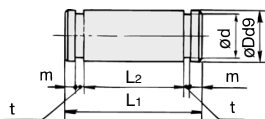

Material: Carbon steel

[mm]

Part no.	Applicable bore size [mm]	D <sub>d9</sub>	L <sub>1</sub>	d	L <sub>2</sub>	m	t	Included retaining ring
CD-G02	20	8 <sup>-0.040</sup> <sub>-0.076</sub>	43.4	7.6	38.6	1.5	0.9	Type C8 for axis
CD-G25	25	10 <sup>-0.040</sup> <sub>-0.076</sub>	48	9.6	42.6	1.55	1.15	Type C10 for axis
CD-G03	32	12 <sup>-0.050</sup> <sub>-0.093</sub>	59.4	11.5	54	1.55	1.15	Type C12 for axis
CD-G04	40	14 <sup>-0.050</sup> <sub>-0.093</sub>	71.4	13.4	65	2.05	1.15	Type C14 for axis
CD-G05	50	16 <sup>-0.050</sup> <sub>-0.093</sub>	86	15.2	79.6	2.05	1.15	Type C16 for axis
CD-G06	63	18 <sup>-0.050</sup> <sub>-0.093</sub>	105.4	17	97.8	2.45	1.35	Type C18 for axis

\* Retaining rings are included.

\* A clevis pin and a knuckle pin are common for bore sizes ∅80 and ∅100.

### Double Knuckle Joint

#### Y-G02, G03

Material: Carbon steel

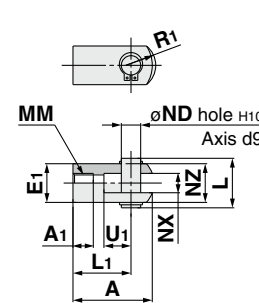

#### Y-G04, G05, G08, G10

Material: Cast iron

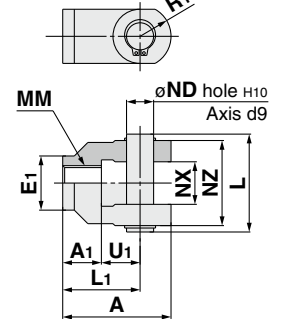

[mm]

Part no.	Applicable bore size [mm]	A	A <sub>1</sub>	E <sub>1</sub>	L <sub>1</sub>	MM	R <sub>1</sub>	U <sub>1</sub>	ND	NX	NZ	L	Applicable pin part no.
Y-G02	20	34	8.5	□16	25	M8 x 1.25	10.3	11.5	8	8 <sup>+0.4</sup> <sub>+0.2</sub>	16	21	IY-G02
Y-G03	25, 32	41	10.5	□20	30	M10 x 1.25	12.8	14	10	10 <sup>+0.4</sup> <sub>+0.2</sub>	20	25.6	IY-G03
Y-G04	40	42	16	∅22	30	M14 x 1.5	12	14	10	18 <sup>+0.5</sup> <sub>+0.3</sub>	36	41.6	IY-G04
Y-G05	50, 63	56	20	∅28	40	M18 x 1.5	16	20	14	22 <sup>+0.5</sup> <sub>+0.3</sub>	44	50.6	IY-G05
Y-G08	80	71	23	∅38	50	M22 x 1.5	21	27	18	28 <sup>+0.5</sup> <sub>+0.3</sub>	56	64	IY-G08
Y-G10	100	79	24	∅44	55	M26 x 1.5	24	31	22	32 <sup>+0.5</sup> <sub>+0.3</sub>	64	72	IY-G10

\* A knuckle pin and retaining rings are included.

### Rod End Nut

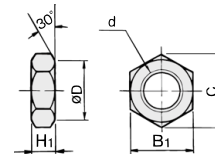

Material: Carbon steel

[mm]

Part no.	Applicable bore size [mm]	d	H <sub>1</sub>	B <sub>1</sub>	C	D
NT-02	20	M8 x 1.25	5	13	(15)	12.5
NT-03	25, 32	M10 x 1.25	6	17	(19.6)	16.5
NT-G04	40	M14 x 1.5	8	19	(21.9)	18
NT-05	50, 63	M18 x 1.5	11	27	(31.2)	26
NT-08	80	M22 x 1.5	13	32	(37.0)	31
NT-10	100	M26 x 1.5	16	41	(47.3)	39

\* Stainless steel mounting brackets and accessories are also available. For details ⇨ p. 14

## Rod End

### KJ□D

Material: Carbon steel

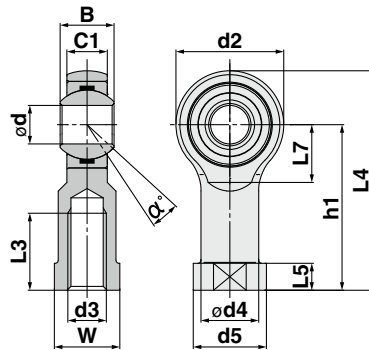

Model	Applicable bore size [mm]	dH7	d3	B <sup>+0</sup> <sub>-0.12</sub>	C1	d2	d4	d5	h1	L3 <sub>min</sub>	L4	L5	L7	W	α°	Allowable radial static load [kN]	Weight [kg]
KJ8D	20	8	M8 x 1.25	12	9	24	12.5	16	36	16	48	5	13	14	14	12	0.05
KJ10D	25, 32	10	M10 x 1.25	14	10.5	28	15	19	43	20	57	6.5	15	17	13	14	0.07
KJ14D	40	14	M14 x 1.5	19	13.5	36	20	25	57	25	75	8	19	22	15	36	0.16
KJ18D	50, 63	18	M18 x 1.5	23	16.5	46	25	31	71	32	94	10	25	27	15	51	0.30
KJ22D	80	22	M22 x 1.5	28	20	54	30	37	84	37	111	12	29	32	15	75	0.49
KJ26D	100	25	M26 x 1.5	31	22	60	33.5	42	94	48	124	12	32	36	15	85	0.67

\* The allowable radial load shows the allowable value of a single rod end. When the rod end is used for connecting to a cylinder, the allowable radial load conforms to the cylinder specifications.

## Material Stainless Steel Mounting Brackets, Rod End Brackets/Part Nos.

Bore size [mm]	Foot bracket	Single knuckle joint	Double knuckle joint*1	Knuckle joint pin*1	Rod end nut
20	—	I-G02SUS	Y-G02SUS	IY-G02SUS	NT-02SUS
25	—	I-G03SUS	Y-G03SUS	IY-G03SUS	NT-03SUS
32	CG-L032SUS	I-G04SUS	Y-G04SUS	IY-G04SUS	NT-G04SUS
40	CG-L040SUS	I-G05SUS	Y-G05SUS	IY-G05SUS	NT-05SUS
50	CG-L050SUS	I-G08SUS	Y-G08SUS	IY-G08SUS	NT-08SUS
63	CG-L063SUS	I-G10SUS	Y-G10SUS	IY-G10SUS	NT-10SUS
80	CG-L080SUS				
100	CG-L100SUS				

\*1 A knuckle pin and retaining rings are included with the double knuckle joint. Retaining rings are included with the knuckle joint pin.

## Dimensions

The single knuckle joint, double knuckle joint, knuckle pin, and rod end nut are the same as the standard type.

### Foot bracket

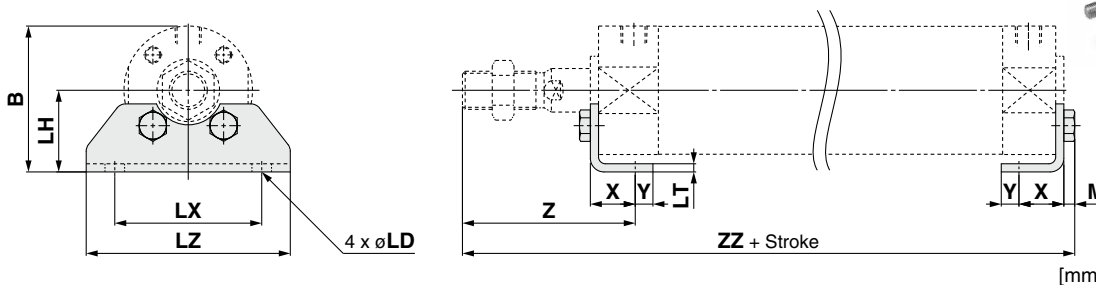

Bore size	B	LD	LH	LT	LX	LZ	M	X	Y	Z	ZZ
32	44	7.2	[25]	[3]	[44]	60	[3.5]	[16]	6	[53]	[117.5]
40	53.5	7.2	[30]	[3]	[54]	75	[4]	[16.5]	6.5	[63.5]	[135]
50	69	[10]	[40]	4	[66]	90	5.5	21.5	11.5	[75.5]	[157.5]
63	81	[12]	[45]	4	[82]	110	7	21.5	11.5	[75.5]	159
80	99.5	12	[55]	4	[100]	130	7	28	17	[95]	190
100	125	[14]	[70]	[6]	[120]	160	8	[30]	15	[95]	193

\* [ ]: Same as the standard type

\* Supplied with 4 mounting screws



# CG1 Series Auto Switch Mounting

## Auto Switch Proper Mounting Position (Detection at stroke end) and Mounting Height

**Solid state auto switch**  
**D-M9□/M9□W, D-M9□A**  
 ø20 to ø63

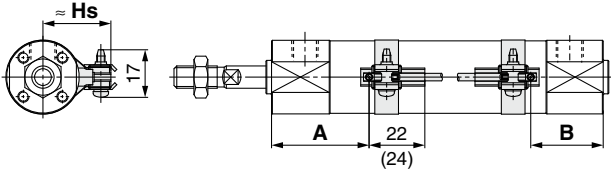

( ): Dimension of the D-M9□A  
 A and B are the dimensions from the end of the head cover/rod cover to the end of the auto switch.

**D-M9□V/M9□WV, D-M9□AV**  
 ø20 to ø63

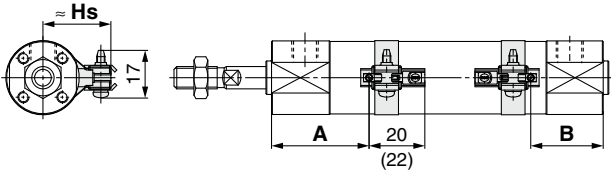

( ): Dimension of the D-M9□AV  
 A and B are the dimensions from the end of the head cover/rod cover to the end of the auto switch.

**D-G5/K5/G5□W/G5BA**  
**D-K59W, D-G59F, D-G5NT**  
 ø20 to ø100

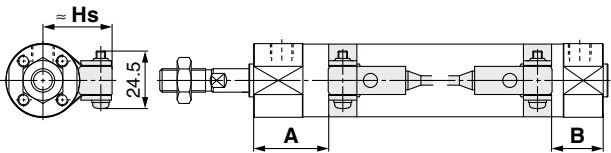

**D-H7□/H7□W**  
**D-H7NF/H7BA, D-H7C**  
 ø20 to ø63

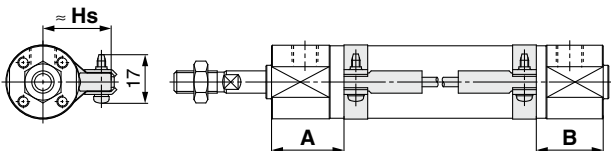

**Reed auto switch**  
**D-A9□**  
 ø20 to ø63

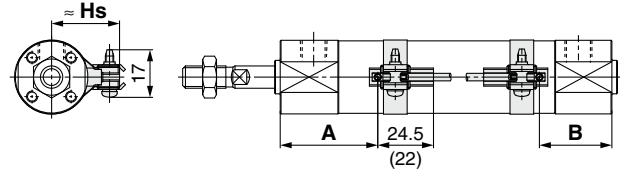

( ): Dimension of the D-A96  
 A and B are the dimensions from the end of the head cover/rod cover to the end of the auto switch.

**D-A9□V**  
 ø20 to ø63

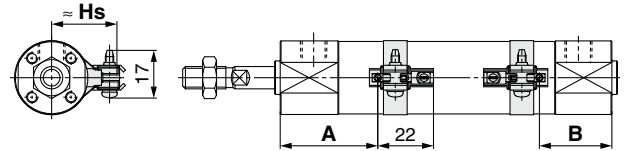

A and B are the dimensions from the end of the head cover/rod cover to the end of the auto switch.

**D-C7/C8, D-C73C/C80C**  
 ø20 to ø63

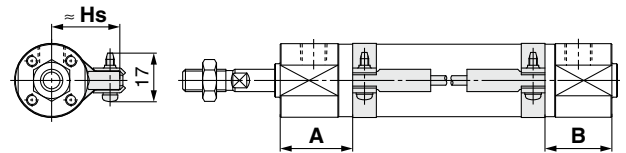

**D-B5/B6/B59W**  
 ø20 to ø100

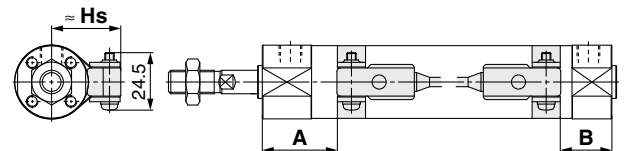

**Auto Switch Proper Mounting Position (Detection at stroke end) and Mounting Height**

**Auto Switch Proper Mounting Position**

[mm]

Auto switch model	D-M9□ D-M9□V D-M9□W D-M9□WV D-M9□A D-M9□AV		D-A9□ D-A9□V		D-H7□W D-H7NF D-H7BA D-H7□ D-H7C		D-C7□ D-C80 D-C73C D-C80C		D-G5□/K59 D-G5□W/K59W D-G59F D-G5NT D-G5BA		D-B5□ D-B64		D-B59W	
	A	B	A	B	A	B	A	B	A	B	A	B	A	B
<b>20</b>	29.5	27.5	25.5	23.5	25	23	26	24	21.5	19.5	20	19	23	21
<b>25</b>	29	28	25	24	24.5	23.5	25.5	24.5	21	20	19.5	19.5	22.5	21.5
<b>32</b>	29.5	29.5	25.5	25.5	25	25	26	26	21.5	21.5	20	20	23	23
<b>40</b>	33	33	29	29	28.5	28.5	29.5	29.5	25	25	23.5	23.5	26.5	26
<b>50</b>	39.5	38.5	35.5	34.5	35	34	36	35	31.5	30.5	30	29	33	32
<b>63</b>	39.5	38.5	35.5	34.5	35	34	36	35	31.5	30.5	30	29	33	32
<b>80</b>	—	—	—	—	—	—	—	—	43	37	41.5	35.5	44.5	38.5
<b>100</b>	—	—	—	—	—	—	—	—	41	39	39.5	37.5	42.5	40.5

\* Adjust the auto switch after confirming the operating conditions in the actual setting.

**Auto Switch Mounting Height**

[mm]

Auto switch model	D-M9□(V) D-M9□W(V) D-M9□A(V) D-A9□(V)		D-H7□ D-H7□W D-H7NF D-H7BA D-C7/C8		D-C73C D-C80C		D-G5/K5 D-G5□W D-K59W D-B5/B6 D-B59W		D-G5NT D-G59F D-H7C D-G5BA	
	Hs		Hs		Hs		Hs		Hs	
<b>20</b>	26.5		27		27.5					
<b>25</b>	29		29.5		30					
<b>32</b>	32.5		33		33.5					
<b>40</b>	37		37.5		38					
<b>50</b>	42.5		43		43.5					
<b>63</b>	49.5		50		50.5					
<b>80</b>	—		—		59					
<b>100</b>	—		—		69.5					

## Minimum Stroke for Auto Switch Mounting

n: Number of auto switches [mm]

Auto switch model	Number of auto switches				
	With 1 pc.	With 2 pcs.		With n pcs.	
		Different surfaces	Same surface	Different surfaces	Same surface
<b>D-M9□</b>	5	15*1	40*1	$20 + 35 \frac{(n-2)}{2}$ (n = 2, 4, 6...)*3	$55 + 35(n-2)$ (n = 2, 3, 4, 5...)
<b>D-M9□W</b>	10	15*1	40*1	$20 + 35 \frac{(n-2)}{2}$ (n = 2, 4, 6...)*3	$55 + 35(n-2)$ (n = 2, 3, 4, 5...)
<b>D-M9□A</b>	10	25	40*1	$25 + 35 \frac{(n-2)}{2}$ (n = 2, 4, 6...)*3	$60 + 35(n-2)$ (n = 2, 3, 4, 5...)
<b>D-A9□</b>	5	15	30*1	$15 + 35 \frac{(n-2)}{2}$ (n = 2, 4, 6...)*3	$50 + 35(n-2)$ (n = 2, 3, 4, 5...)
<b>D-M9□V</b>	5	20	35	$20 + 35 \frac{(n-2)}{2}$ (n = 2, 4, 6...)*3	$35 + 35(n-2)$ (n = 2, 3, 4, 5...)
<b>D-A9□V</b>	5	15	25	$15 + 35 \frac{(n-2)}{2}$ (n = 2, 4, 6...)*3	$25 + 35(n-2)$ (n = 2, 3, 4, 5...)
<b>D-M9□WV</b> <b>D-M9□AV</b>	10	20	35	$20 + 35 \frac{(n-2)}{2}$ (n = 2, 4, 6...)*3	$35 + 35(n-2)$ (n = 2, 3, 4, 5...)
<b>D-C7□</b> <b>D-C80</b>	5	15	50	$15 + 45 \frac{(n-2)}{2}$ (n = 2, 4, 6...)*3	$50 + 45(n-2)$ (n = 2, 3, 4, 5...)
<b>D-H7□</b> <b>D-H7□W</b> <b>D-H7BA</b> <b>D-H7NF</b>	10	15	60	$15 + 45 \frac{(n-2)}{2}$ (n = 2, 4, 6...)*3	$60 + 45(n-2)$ (n = 2, 3, 4, 5...)
<b>D-H7C</b> <b>D-C73C</b> <b>D-C80C</b>	5	15	65	$15 + 50 \frac{(n-2)}{2}$ (n = 2, 4, 6...)*3	$65 + 50(n-2)$ (n = 2, 3, 4, 5...)
<b>D-G5□</b> <b>D-K59□</b> <b>D-B5□</b> <b>D-B64</b>	5	15	75	$15 + 50 \frac{(n-2)}{2}$ (n = 2, 4, 6...)*3	$75 + 55(n-2)$ (n = 2, 3, 4, 5...)
<b>D-B59W</b>	10	20	75	$20 + 50 \frac{(n-2)}{2}$ (n = 2, 4, 6...)*3	$75 + 55(n-2)$ (n = 2, 3, 4, 5...)

\*3 When "n" is an odd number, an even number that is one larger than the odd number is to be used for the calculation.

\*1 Auto switch mounting

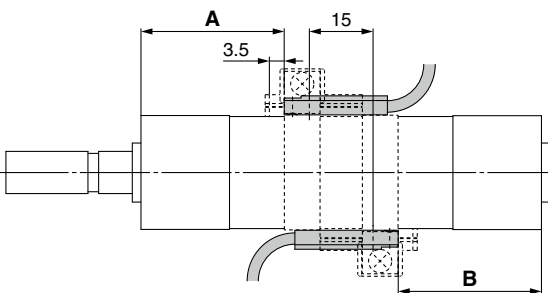
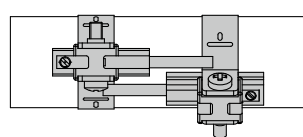
Auto switch model	With 2 auto switches	
	Different surfaces*1	Same surface*1
 <p>Correct auto switch mounting position is 3.5 mm from the back face of the switch holder.</p>	 <p>The auto switch is mounted by slightly displacing it in a direction (cylinder tube circumferential exterior) so that the auto switch and lead wire do not interfere with each other.</p>	
<b>D-M9□</b> <b>D-M9□W</b>	Less than 20 mm stroke*2	Less than 55 mm stroke*2
<b>D-M9□A</b>	Less than 20 mm stroke*2	Less than 60 mm stroke*2
<b>D-A9□</b>	—	Less than 50 mm stroke*2

\*2 Minimum stroke for auto switch mounting in types other than those mentioned in \*1



## Auto Switch Mounting Brackets/Part Nos.

Auto switch model	Bore size (mm)							
	20	25	32	40	50	63	80	100
<b>D-M9□(V)</b> <b>D-M9□W(V)</b> <b>D-A9□(V)</b>	*1 BMA3-020 (A set of a, b, c, d)	*1 BMA3-025 (A set of a, b, c, d)	*1 BMA3-032 (A set of a, b, c, d)	*1 BMA3-040 (A set of a, b, c, d)	*1 BMA3-050 (A set of a, b, c, d)	*1 BMA3-063 (A set of a, b, c, d)	—	—
<b>D-M9□A(V)*2</b>	BMA3-020S (A set of b, c, e, f)	BMA3-025S (A set of b, c, e, f)	BMA3-032S (A set of b, c, e, f)	BMA3-040S (A set of b, c, e, f)	BMA3-050S (A set of b, c, e, f)	BMA3-063S (A set of b, c, e, f)	—	—

Switch bracket

a Transparent (Nylon)\*1

e White (PBT)

Auto switch

d Auto switch mounting screw  
(Low carbon steel wire rod)

f (Stainless steel)

(With switch installed)

c Auto switch mounting band

\* Band (c) is mounted so that the projected part is on the internal side (contact side with the tube).

<b>D-H7□</b> <b>D-H7□W</b> <b>D-H7NF</b> <b>D-C7□/C80</b> <b>D-C73C/C80C</b>	BMA2-020A (A set of c and d)	BMA2-025A (A set of c and d)	BMA2-032A (A set of c and d)	BMA2-040A (A set of c and d)	BMA2-050A (A set of c and d)	BMA2-063A (A set of c and d)	—	—
<b>D-H7BA</b>	BMA2-020AS (A set of c and f)	BMA2-025AS (A set of c and f)	BMA2-032AS (A set of c and f)	BMA2-040AS (A set of c and f)	BMA2-050AS (A set of c and f)	BMA2-063AS (A set of c and f)	—	—
<b>D-G5□/K59</b> <b>D-G5□W/K59W</b> <b>D-G5BA/G59F</b> <b>D-G5NT</b> <b>D-B5□/B64</b> <b>D-B59W</b>	BA-01 (A set of c and d)	BA-02 (A set of c and d)	BA-32 (A set of c and d)	BA-04 (A set of c and d)	BA-05 (A set of c and d)	BA-06 (A set of c and d)	BA-08 (A set of c and d)	BA-10 (A set of c and d)

\*1 Since the switch bracket (made of nylon) is affected in an environment where alcohol, chloroform, methylamines, hydrochloric acid, or sulfuric acid is splashed over, so it cannot be used.  
Please contact SMC regarding other chemicals.

\*2 When mounting a D-M9□A(V) type auto switch, if the switch bracket is mounted on the indicator light, it may damage the auto switch. Therefore, be sure to avoid mounting the switch bracket on the indicator light.

### Band Mounting Brackets Set Part Nos.

Set part no.	Contents
<b>BJ4-1</b>	· Switch bracket (White/PBT) (e) · Switch holder (b)
<b>BJ5-1</b>	· Switch bracket (Transparent/Nylon) (a) · Switch holder (b)

### [Stainless Steel Mounting Screw]

The following stainless steel mounting screw kit is available. Use it in accordance with the operating environment.  
(Since the auto switch mounting bracket is not included, order it separately.)

BBA3: D-B5/B6/G5/K5 types

\* Refer to the **Web Catalog** for details on the BBA3.

When the D-G5BA type auto switch is shipped independently, the BBA3 is attached.







# CG1 Series

## Operating Range

Auto switch model	Bore size							
	20	25	32	40	50	63	80	100
D-M9□(V) D-M9□W(V) D-M9□A(V)	4.5	5	4.5	5.5	5	5.5	—	—
D-A9□	7	6	8	8	8	9	—	—
D-C7/C80 D-C73C/C80C	8	10	9	10	10	11	—	—
D-B5□/B64	8	10	9	10	10	11	11	11
D-B59W	13	13	14	14	14	17	16	18
D-H7□/H7□W D-H7NF/H7BA	4	4	4.5	5	6	6.5	—	—
D-H7C	7	8.5	9	10	9.5	10.5	—	—
D-G5□/G5□W/G59F D-G5BA/K59/K59W	4	4	4.5	5	6	6.5	6.5	7
D-G5NT	4	4	4.5	5	6	6.5	6.5	7

\* Values which include hysteresis are for reference purposes only. They are not a guarantee (assuming approximately ±30% dispersion) and may change substantially depending on the ambient environment.

## Cylinder Mounting Bracket, by Stroke/Auto Switch Mounting Surfaces

Auto switch model	Basic, Foot, Flange, Clevis			Trunnion		
	With 1 pc. (Rod cover side)	With 2 pcs. (Different surfaces)	With 2 pcs. (Same surface)	With 1 pc. (Rod cover side)	With 2 pcs. (Different surfaces)	With 2 pcs. (Same surface)
Auto switch mounting surface	Port surface 	Port surface 	Port surface 			
Auto switch model						
D-M9□(V) D-M9□W(V) D-M9□A(V) D-A9□	10 st or more	15 to 44 st	45 st or more	10 st or more	15 to 44 st	45 st or more
D-C7/C8	10 st or more	15 to 49 st	50 st or more	10 st or more	15 to 49 st	50 st or more
D-H7□/H7□W D-H7BA/H7NF	10 st or more	15 to 59 st	60 st or more	10 st or more	15 to 59 st	60 st or more
D-H7C/C73C/C80C	10 st or more	15 to 64 st	65 st or more	10 st or more	15 to 64 st	65 st or more
D-G5/K5/B5/B6 D-G5□W/K59W/G5BA D-G59F/G5NT	10 st or more	15 to 74 st	75 st or more	10 st or more	15 to 74 st	75 st or more
D-B59W	15 st or more	20 to 74 st	75 st or more	15 st or more	20 to 74 st	75 st or more

\* Trunnion type is not available for ø80 and ø100.

\* Adjust the auto switch mounting angle according to the customer's application.

**Other than the applicable auto switches listed in "How to Order," the following auto switches are also mountable.**

Refer to the **Web Catalog** for detailed specifications.

Type	Model	Electrical entry	Features	Applicable bore size
Solid state	D-H7A1, H7A2, H7B	Grommet (In-line)	—	ø20 to ø63
	D-H7NW, H7PW, H7BW		Diagnostic indication (2-color indicator)	
	D-H7BA		Water resistant (2-color indicator)	
	D-G5NT		With timer	ø20 to ø100
Reed	D-C73, C76		—	ø20 to ø63
	D-C80		Without indicator light	
	D-B53		—	ø20 to ø100

\* With pre-wired connector is also available for solid state auto switches. For details, refer to the **Web Catalog**.

\* Normally closed (NC = b contact) solid state auto switches (D-M9□E(V)) are also available. For details, refer to the **Web Catalog**.

# Prior to Use

## Auto Switch Connections and Examples

### Sink Input Specifications

#### 3-wire, NPN

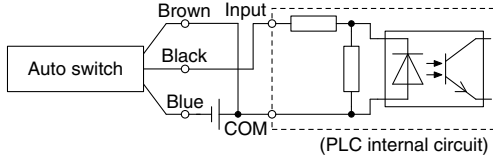

#### 2-wire

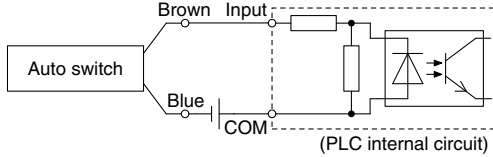

### Source Input Specifications

#### 3-wire, PNP

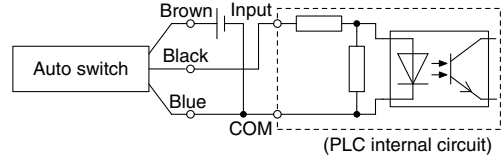

#### 2-wire

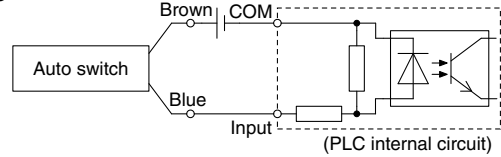

Connect according to the applicable PLC input specifications, as the connection method will vary depending on the PLC input specifications.

### Examples of AND (Series) and OR (Parallel) Connections

\* When using solid state auto switches, ensure the application is set up so the signals for the first 50 ms are invalid. Depending on the operating environment, the product may not operate properly.

#### 3-wire AND connection for NPN output (Using relays)

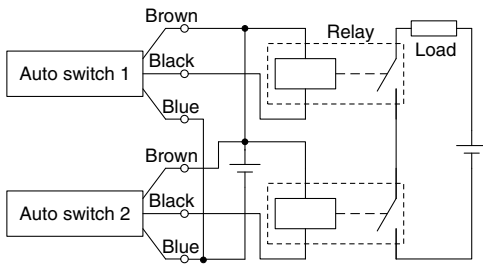

#### (Performed with auto switches only)

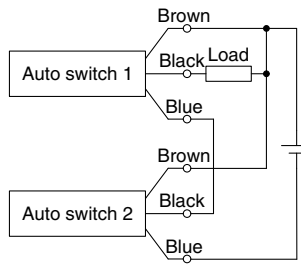

#### 3-wire OR connection for NPN output

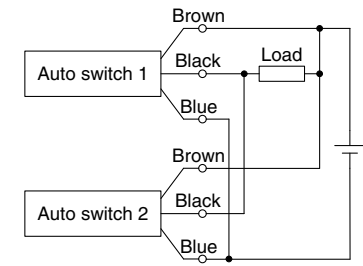

#### 3-wire AND connection for PNP output (Using relays)

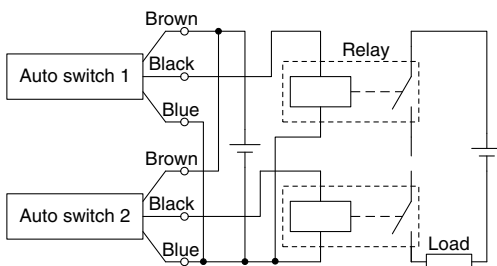

#### (Performed with auto switches only)

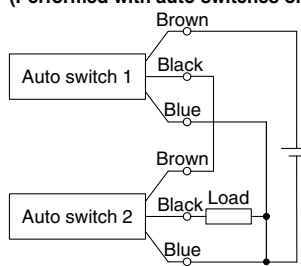

#### 3-wire OR connection for PNP output

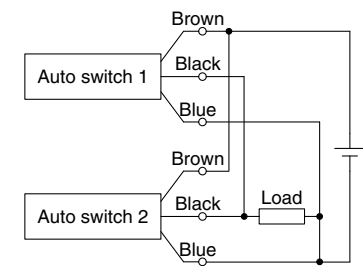

#### 2-wire AND connection

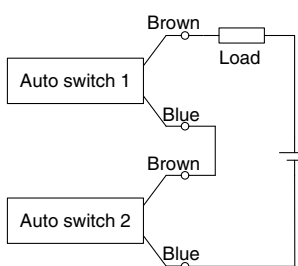

When two auto switches are connected in series, a load may malfunction because the load voltage will decline when in the ON state. The indicator lights will light up when both of the auto switches are in the ON state. Auto switches with a load voltage less than 20 V cannot be used. Please contact SMC if using AND connection for a heat-resistant solid state auto switch or a trimmer switch.

Example) Load voltage at ON  
 Power supply voltage: 24 VDC  
 Internal voltage drop: 4 V  
 Load voltage at ON = Power supply voltage –  
 Internal voltage drop x 2 pcs.  
 = 24 V – 4 V x 2 pcs.  
 = 16 V

#### 2-wire OR connection

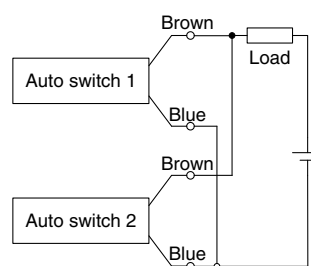

(Solid state)  
 When two auto switches are connected in parallel, malfunction may occur because the load voltage will increase when in the OFF state.

(Reed)  
 Because there is no current leakage, the load voltage will not increase when turned OFF. However, depending on the number of auto switches in the ON state, the indicator lights may sometimes grow dim or not light up, due to the dispersion and reduction of the current flowing to the auto switches.

Example) Load voltage at OFF  
 Leakage current: 1 mA  
 Load impedance: 3 kΩ  
 Load voltage at OFF = Leakage current x 2 pcs. x  
 Load impedance  
 = 1 mA x 2 pcs. X 3 kΩ  
 = 6 V

# CG1 Series

## Simple Specials/Made to Order Common Specifications

Please contact SMC for detailed specifications, delivery times, and prices.



### Simple Specials

The following special specifications can be ordered as a simplified made-to-order. Please contact your local sales representative for more details.

Symbol	Specifications	CG1 (Standard)		Symbol	Page
		Double acting	Single rod		
-XA0 to 30	Change of rod end shape			-XA0 to 30	22

### Made to Order Common Specifications

Symbol	Specifications	CG1 (Standard)		Symbol	Page
		Double acting	Single rod		
-XC3	Special port location			-XC3	24
-XC4	With heavy duty scraper			-XC4	24
-XC6	Made of stainless steel			-XC6	24
-XC20	Head cover axial port			-XC20	25
-XC27	Double clevis and double knuckle joint pins made of stainless steel			-XC27	25
-XC29	Double knuckle joint with spring pin			-XC29	25
-XC35	With coil scraper			-XC35	26
-XC85	Grease for food processing equipment			-XC85	26
-X446	PTFE grease			-X446	27
-X3252	Interchangeable for long strokes for existing bore size			-X3252	27

# CG1 Series Simple Specials

The following changes are dealt with through the Simple Specials System.

Please contact your local sales representative for more details.

## 1 Change of Rod End Shape Symbol -XA0 to XA30

Series		Action	Symbol for change of rod end shape	Note
Standard	<b>CG1</b>	Double acting, Single rod	XA0 to 30	Excludes cylinders with a rod end bracket

### Precautions

- SMC will make appropriate arrangements if no dimension, tolerance, or finish instructions are given in the diagram.
- Standard dimensions marked with "\*" will be as follows to the rod diameter (D). Enter any special dimension you require.

- $6 < D \leq 25 \rightarrow D - 2 \text{ mm}$ ,  $D > 25 \rightarrow D - 4 \text{ mm}$
- "A0" is the same shape as the standard type. (The specifications of A0 are that only dimensions A and H are changed from the standard type.)

<b>Symbol: A0</b> 	<b>Symbol: A1</b> 	<b>Symbol: A2</b> 	<b>Symbol: A3</b> 
<b>Symbol: A4</b> 	<b>Symbol: A5</b> 	<b>Symbol: A6</b> 	<b>Symbol: A7</b> 
<b>Symbol: A8</b> 	<b>Symbol: A9</b> = C0.5 file chamfer 	<b>Symbol: A10</b> 	<b>Symbol: A11</b> 
<b>Symbol: A12</b> 	<b>Symbol: A13</b> 	<b>Symbol: A14</b> 	<b>Symbol: A15</b> 
<b>Symbol: A16</b> 	<b>Symbol: A17</b> 	<b>Symbol: A18</b> 	<b>Symbol: A19</b> 

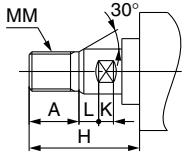
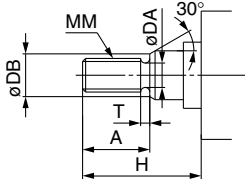
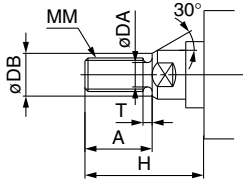
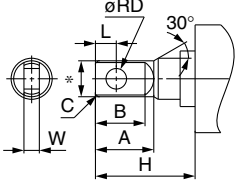
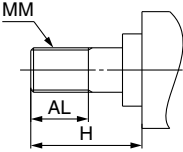
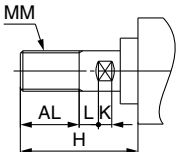
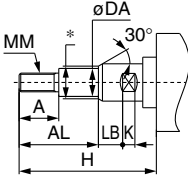
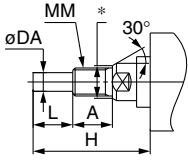
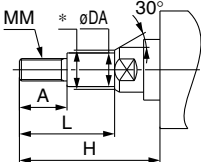
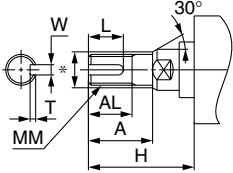
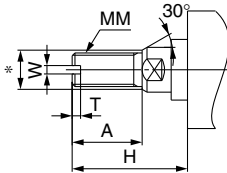

# CG1 Series

<p><b>Symbol: A20</b></p> 	<p><b>Symbol: A21</b></p> 	<p><b>Symbol: A22</b></p> 	<p><b>Symbol: A23</b></p> 
<p><b>Symbol: A24</b></p> 	<p><b>Symbol: A25</b></p> 	<p><b>Symbol: A26</b></p> 	<p><b>Symbol: A27</b></p> 
<p><b>Symbol: A28</b></p> 	<p><b>Symbol: A29</b></p> 	<p><b>Symbol: A30</b></p> 	

# CG1 Series

# Made to Order Common Specifications

Please contact SMC for detailed dimensions, specifications, and delivery times.



## 1 Special Port Location

Symbol  
**-XC3**

The locations of the connection port of the rod/head cover are different than those of the standard type.

### Applicable Series

Series	Description	Model	Action	Note
CG1	Standard	CG1-Z1	Double acting, Single rod	

### How to Order

Standard model no. **-XC3** **A** **B**

### Specifications:

Same as those of the standard type

Special port location

Head port location viewed from the rod side  
Rod port location viewed from the rod side

\* For port locations, refer to the following diagrams and select either A, B, C, or D.

### Port Locations

Corresponding symbol of mounting bracket (Positional relationships)	
<p>* Viewed from the rod side, the ports are rendered A, B, C, and D, in the clockwise direction.</p>	<p>* Viewed from the rod side, with the clevis positioned as shown in the diagram, the ports are rendered A, B, C, and D, in the clockwise direction.</p>

## 2 With Heavy Duty Scraper

Symbol  
**-XC4**

With the heavy duty scraper on the wiper ring, this cylinder is suitable for use in environments where die-cast equipment or construction machinery is exposed to dirt or sand, or in environments with significant amounts of dust.

### Applicable Series

Series	Description	Model	Action	Note
CG1	Air cylinder	CG1-Z1	Double acting, Single rod	Applicable to ø32 to ø63

### How to Order

Standard model no. **-XC4**

With heavy duty scraper

Specifications: Same as those of the standard type

### Caution

Heavy duty scrapers cannot be replaced.

- Since heavy duty scrapers are press-fit, please contact SMC to replace them.

### Dimensions (Dimensions other than those below are the same as those of the standard type.)

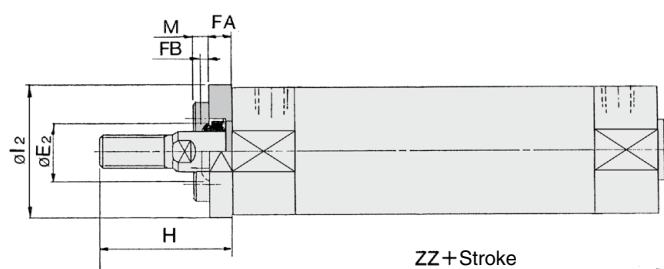

Bore size	E <sub>2</sub>	FA	FB	M	l <sub>2</sub>	H		ZZ	
						Male thread	Female thread	Male thread	Female thread
32	17	8	3	5	38	48	28	121	101
40	21	8	3	3.5	47	58	29	138	109
50	26	9	3	4.5	58	66	30	158	122
63	26	9	3	5.5	72	66	30	158	122

\* On the axial foot type and the rod flange type, the mounting bracket is wedged and bolted between the cylinder and the scraper at the time of shipment. On other types, it is placed in the same package but does not come assembled.

## 3 Made of Stainless Steel

Symbol  
**-XC6**

Suitable for cases in which rust is likely to be generated due to immersion in water or in which corrosion is likely to occur

### Applicable Series

Series	Description	Model	Action	Note
CG1	Air cylinder	CG1-Z1	Double acting, Single rod	

### How to Order

Standard model no. **-XC6**

Made of stainless steel

### Specifications

Parts changed to stainless steel	Piston rod, Rod end nut
Specifications other than the above and dimensions	Same as those of the standard type

Stainless steel mounting brackets and rod end brackets (foot bracket, single knuckle joint, double knuckle joint) are also available. For details ⇨ p. 14

# CG1 Series

## 4 Head Cover Axial Port

Symbol  
**-XC20**

Head side port position is changed to the axial direction. (Standard head side port is plugged with hexagon socket head screw.)

### Applicable Series

Series	Description	Model	Action	Note
CG1	Air cylinder	CG1-Z1	Double acting, Single rod	

### How to Order

Standard model no. **-XC20**  
 Head cover axial port

### Specifications: Same as those of the standard type

- \* Operate within the maximum piston speed and the allowable kinetic energy.
- \* Be sure to use the speed controller since head side port has no throttle.

### Dimensions (Dimensions other than those below are the same as those of the standard type.)

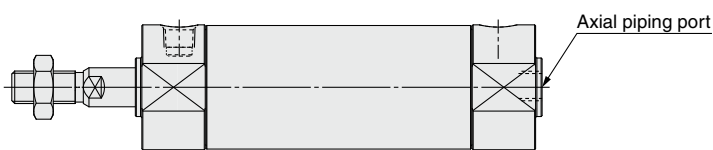

Bore size [mm]	Port size
20, 25, 32, 40	Rc1/8
50, 63	Rc1/4
80	Rc3/8
100	Rc1/2

## 5 Double Clevis and Double Knuckle Joint Pins Made of Stainless Steel

Symbol  
**-XC27**

To prevent the oscillating portion of the double clevis or the double knuckle joint from rusting, the material of the pin and the retaining ring has been changed to stainless steel.

### Applicable Series

Series	Description	Model	Action	Note
CG1	Standard	CG1-Z1	Double acting, Single rod*1	

\*1 Excludes cylinders with double knuckle joint bracket in How to Order

### Specifications

Mounting type	Double clevis type (D), double knuckle joint only
Pin and retaining ring material	Stainless steel 304
Specifications other than the above	Same as those of the standard type

### How to Order

CG1D Standard model no. **-XC27**  
 Double clevis type Double clevis pin made of stainless steel  
 Y - G02, G03, G04, G05, G08, G10 **-XC27**  
 Double knuckle joint Double knuckle joint pin made of stainless steel  
 IY - G02, G03, G04, G05, G08, G10 **-XC27**  
 CD - G02, G25, G03, G04, G05, G06 **-XC27**  
 Clevis pin Knuckle pin made of stainless steel  
 Clevis pin/Knuckle pin

## 6 Double Knuckle Joint with Spring Pin

Symbol  
**-XC29**

To prevent loosening of the double knuckle joint of standard air cylinder (CM2/CA2 series)

### Applicable Series

Series	Description	Model	Action	Note
CG1	Air cylinder	CG1-Z1	Double acting, Single rod*1	

\*1 Excludes cylinders with rod end bracket in How to Order

### How to Order

Standard model no. **-XC29**  
 Double knuckle joint with spring pin

### Specifications: Same as those of the standard type

\* For mounting bracket, pin is shipped together.

### Dimensions: Same as those of the standard type

**7 With Coil Scraper**

Symbol  
**-XC35**

It gets rid of frost, ice, weld spatter, cutting chips adhered to the piston rod, and protects the seals, etc.

**Applicable Series**

Series	Description	Model	Action	Note
CG1	Air cylinder	CG1-Z1	Double acting, Single rod	

**How to Order**

Standard model no. **-XC35**  
With coil scraper

**Specifications: Same as those of the standard type**

**Dimensions** (Dimensions other than those below are the same as those of the standard type.)

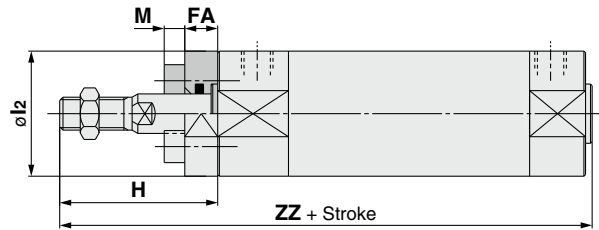

Bore size	FA	H		l <sub>2</sub>	M	ZZ	
		Male thread	Female thread			Male thread	Female thread
20	6	39	27	26	4	110	98
25	6	44	28	31	5	115	99
32	6	44	28	38	5	117	101
40	7	54	29	47	3.5	134	109
50	7	62	30	58	4.5	154	122
63	7	62	30	72	5.5	154	122

- \* Other dimensions are the same as those of the double acting, single rod, standard type.
- \* On the axial foot type and the rod flange type, the mounting bracket is wedged and bolted between the cylinder and the scraper at the time of shipment. On other types, it is placed in the same package but does not come assembled.
- \* For details on the maximum stroke that can be used for each mounting bracket, refer to the stroke selection table (**Web Catalog**).

**8 Grease for Food Processing Equipment**

Symbol  
**-XC85**

Food grade grease (certified by NSF-H1) is used as lubricant.

**Applicable Series**

Series	Description	Model	Action	Note
CG1	Air cylinder	CG1-Z1	Double acting, Single rod	

**How to Order**

Standard model no. **-XC85**  
Grease for food processing equipment

**Specifications**

Seal material	Nitrile rubber
Grease	Grease for food processing equipment
Auto switch	Mountable
Dimensions	Same as those of the standard type
Specifications other than the above	Same as those of the standard type

**Warning Precautions**

Be aware that smoking cigarettes, etc., after your hands have come into contact with the grease used in this cylinder can create a gas that is hazardous to humans.

<Not installable>

Food zone.....An environment where food which will be sold as merchandize, directly touches the cylinder's components

Splash zone.....An environment where food which will not be sold as merchandize, directly touches the cylinder's components

<Installable>

Non-food zone.....An environment where there is no contact with food

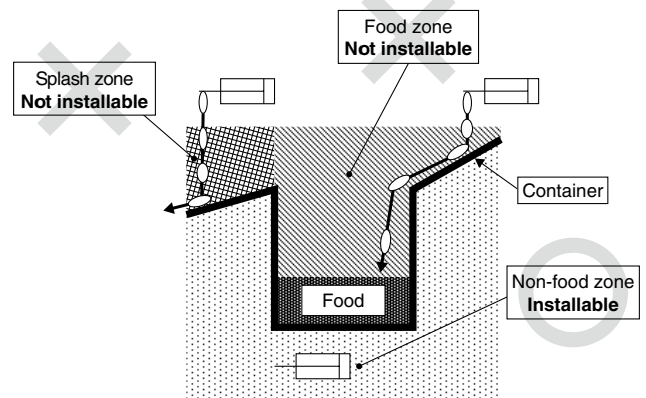

- \* Avoid using this product in the food zone. (Refer to the figure above.)
- \* When the product is used in an area of liquid splash, or a water resistant function is required for the product, please consult SMC.
- \* Operate without lubrication from a pneumatic system lubricator.
- \* Use the following grease pack for the maintenance work. GR-H-010 (Grease: 10 g)
- \* Please contact SMC for details on the maintenance intervals for this cylinder, which differ from those of the standard cylinder.







# CG1 Series

## Specific Product Precautions

Be sure to read this before handling the products. Refer to the back cover for safety instructions. For actuator and auto switch precautions, refer to the “Handling Precautions for SMC Products” and the “Operation Manual” on the SMC website: <https://www.smcworld.com>

### Handling

#### ⚠ Warning

1. Operate within the specified cylinder speed and kinetic energy.  
Otherwise, cylinder and seal damage may occur.
2. When a cylinder is operated with one end fixed and the other free (basic or flange types), a bending moment may act on the cylinder due to the vibration generated at the stroke end, which can damage the cylinder. In such a case, install a mounting bracket to suppress the vibration of the cylinder body or reduce the piston speed so that the cylinder does not vibrate. Also, use a mounting bracket to suppress vibrations when moving the cylinder body or when a cylinder is operated horizontally and fixed at one end at a high speed and frequency.

#### ⚠ Caution

1. Do not apply excessive lateral load to the piston rod.  
Easy checking method  
Minimum operating pressure after the cylinder is mounted to the equipment [MPa] = Minimum operating pressure of cylinder [MPa] + {Load mass [kg] x 9.8 x Friction coefficient of guide/Sectional area of cylinder [mm<sup>2</sup>]}.  
If smooth operation is confirmed within the above value, the load on the cylinder is the resistance of the thrust only and it can be judged as having no lateral load.
2. Do not use the air cylinder as an air-hydro cylinder.  
This may result in oil leakage.
3. Refer to the torque shown in the table below when tightening the foot bracket, flange, or clevis to the cylinder.

Tightening Torque

Unit: N·m

Bore size [mm]	Foot bracket Flange Clevis	Trunnion
20	1.5	1.5 to 2.2
25	2.9	2.5 to 3.5
32	2.9	6.0 to 8.6
40	4.9	10.8 to 14.6
50	11.8	19 to 25
63	24.5	30 to 40
80	24.5	—
100	42.2	—

4. The oil stuck to the cylinder is grease.
5. There is a possibility that the base oil of grease seeps out. The installation of the protective cover is recommended.

### Disassembly/Replacement

#### ⚠ Warning

1. Only people who have sufficient knowledge and experience are allowed to replace seals.  
The person who disassembles and reassembles the cylinder is responsible for the safety of the product. Repeatedly disassembling and reassembling the product may cause wearing or deformation of the screws as well as a decline in screw tightening strength. When reassembling the product, be sure to check the cover and tubing screws for wear, deformities, or any other abnormalities. Operating the product with damaged screws may result in the cover or tubing coming off during operation, which could lead to a serious accident. Caution must be taken to avoid such incidents.

#### ⚠ Caution

1. Bushings cannot be replaced.
2. To replace a seal, apply the specified grease to the new seal before installing it.  
If the cylinder is put into operation without applying grease to the seal, it could cause the seal to wear significantly, leading to premature air leakage.
3. Cylinders with ø50 or larger bore sizes cannot be disassembled.  
When disassembling cylinders with bore sizes of ø20 through ø40, grip the double flat part of either the rod cover or the head cover with a vise and loosen the other side with a wrench or a monkey wrench, etc., and then remove the cover. When re-tightening, tighten approximately 2 degrees more than the original position. (Cylinders with ø50 or larger bore sizes are tightened with a large tightening torque and cannot be disassembled. If disassembly is required, please contact SMC.)
4. When replacing seals, take care not to hurt your hand or finger on the corners of parts.

## Safety Instructions

These safety instructions are intended to prevent hazardous situations and/or equipment damage. These instructions indicate the level of potential hazard with the labels of “**Caution**,” “**Warning**” or “**Danger**.” They are all important notes for safety and must be followed in addition to International Standards (ISO/IEC)\*1), and other safety regulations.

 **Caution:** **Caution** indicates a hazard with a low level of risk which, if not avoided, could result in minor or moderate injury.

 **Warning:** **Warning** indicates a hazard with a medium level of risk which, if not avoided, could result in death or serious injury.

 **Danger:** **Danger** indicates a hazard with a high level of risk which, if not avoided, will result in death or serious injury.

\*1) ISO 4414: Pneumatic fluid power – General rules relating to systems.  
ISO 4413: Hydraulic fluid power – General rules relating to systems.  
IEC 60204-1: Safety of machinery – Electrical equipment of machines.  
(Part 1: General requirements)  
ISO 10218-1: Manipulating industrial robots – Safety.  
etc.

### Warning

#### 1. The compatibility of the product is the responsibility of the person who designs the equipment or decides its specifications.

Since the product specified here is used under various operating conditions, its compatibility with specific equipment must be decided by the person who designs the equipment or decides its specifications based on necessary analysis and test results. The expected performance and safety assurance of the equipment will be the responsibility of the person who has determined its compatibility with the product. This person should also continuously review all specifications of the product referring to its latest catalog information, with a view to giving due consideration to any possibility of equipment failure when configuring the equipment.

#### 2. Only personnel with appropriate training should operate machinery and equipment.

The product specified here may become unsafe if handled incorrectly. The assembly, operation and maintenance of machines or equipment including our products must be performed by an operator who is appropriately trained and experienced.

#### 3. Do not service or attempt to remove product and machinery/equipment until safety is confirmed.

1. The inspection and maintenance of machinery/equipment should only be performed after measures to prevent falling or runaway of the driven objects have been confirmed.
2. When the product is to be removed, confirm that the safety measures as mentioned above are implemented and the power from any appropriate source is cut, and read and understand the specific product precautions of all relevant products carefully.
3. Before machinery/equipment is restarted, take measures to prevent unexpected operation and malfunction.

#### 4. Contact SMC beforehand and take special consideration of safety measures if the product is to be used in any of the following conditions.

1. Conditions and environments outside of the given specifications, or use outdoors or in a place exposed to direct sunlight.
2. Installation on equipment in conjunction with atomic energy, railways, air navigation, space, shipping, vehicles, military, medical treatment, combustion and recreation, or equipment in contact with food and beverages, emergency stop circuits, clutch and brake circuits in press applications, safety equipment or other applications unsuitable for the standard specifications described in the product catalog.
3. An application which could have negative effects on people, property, or animals requiring special safety analysis.
4. Use in an interlock circuit, which requires the provision of double interlock for possible failure by using a mechanical protective function, and periodical checks to confirm proper operation.

### Caution

#### 1. The product is provided for use in manufacturing industries.

The product herein described is basically provided for peaceful use in manufacturing industries.  
If considering using the product in other industries, consult SMC beforehand and exchange specifications or a contract if necessary.  
If anything is unclear, contact your nearest sales branch.

### Limited warranty and Disclaimer/ Compliance Requirements

The product used is subject to the following “Limited warranty and Disclaimer” and “Compliance Requirements”.

Read and accept them before using the product.

#### Limited warranty and Disclaimer

1. The warranty period of the product is 1 year in service or 1.5 years after the product is delivered, whichever is first.\*2)  
Also, the product may have specified durability, running distance or replacement parts. Please consult your nearest sales branch.
2. For any failure or damage reported within the warranty period which is clearly our responsibility, a replacement product or necessary parts will be provided.  
This limited warranty applies only to our product independently, and not to any other damage incurred due to the failure of the product.
3. Prior to using SMC products, please read and understand the warranty terms and disclaimers noted in the specified catalog for the particular products.

##### \*2) Vacuum pads are excluded from this 1 year warranty.

A vacuum pad is a consumable part, so it is warranted for a year after it is delivered.  
Also, even within the warranty period, the wear of a product due to the use of the vacuum pad or failure due to the deterioration of rubber material are not covered by the limited warranty.

#### Compliance Requirements

1. The use of SMC products with production equipment for the manufacture of weapons of mass destruction (WMD) or any other weapon is strictly prohibited.
2. The exports of SMC products or technology from one country to another are governed by the relevant security laws and regulations of the countries involved in the transaction. Prior to the shipment of a SMC product to another country, assure that all local rules governing that export are known and followed.

### Caution

#### SMC products are not intended for use as instruments for legal metrology.

Measurement instruments that SMC manufactures or sells have not been qualified by type approval tests relevant to the metrology (measurement) laws of each country. Therefore, SMC products cannot be used for business or certification ordained by the metrology (measurement) laws of each country.

## Safety Instructions

Be sure to read the “Handling Precautions for SMC Products” (M-E03-3) and “Operation Manual” before use.