

Compressed Air Preparation Filter

Compressed Air Purity Class **ISO 8573**



* Depends on the size and max. operating pressure

Main Line Filter *AFF Series*

1 μm Water droplet removal

Mist Separator *AM Series*

0.1 μm Oil mist separation and removal

Micro Mist Separator *AMD Series*

0.01 μm Oil mist separation and removal

Flow Capacity

14.5 ^{*1} m^3/min (ANR)

20% improvement

Pressure Drop

5 kPa or less

60% reduction (For AMD)

Weight

5.0 ^{*1} kg

52% reduction

Depth

160 mm

Face to Face

170 mm



Improved Nominal Filtration Rating

AFF **1** μm (Existing model: 3 μm)

AM **0.1** μm (Existing model: 0.3 μm)

*1 For AFF/AM/AMD90

AFF/AM/AMD Series

Compressed Air Preparation Filter AFF/AM/AMD Series

Variations

A model with **11.0 m³/min** flow capacity (Size 80D) has been newly added. More choices are available depending on the customer's required flow rate.

Series	Size	Port size			Flow capacity [m ³ /min (ANR)]	Option/ Accessory
		1	1 1/2	2		
AFF Series Main Line Filter Large dust particle filtration, Water droplet separation Water droplet removal ratio: 99% Nominal filtration rating: 1 μm [Filtration efficiency: 99%]	70D	●	●		7.0	<ul style="list-style-type: none"> • Bracket • Auto drain (1.0 MPa) • Auto drain (1.6 MPa) • Drain guide
	80D		●		11.0	
	90D		●	●	14.5	
AM Series Mist Separator Dust filtration, Oil mist separation Nominal filtration rating: 0.1 μm [Filtration efficiency: 99%] Oil mist concentration on the outlet side: Max. 1.0 mg/m ³ (ANR) [≈ 0.8 ppm]	70D	●	●		7.0	
	80D		●		11.0	
	90D		●	●	14.5	
AMD Series Micro Mist Separator Dust filtration, Oil mist separation Nominal filtration rating: 0.01 μm [Filtration efficiency: 99.9%] Oil mist concentration on the outlet side: Max. 0.1 mg/m ³ (ANR) [≈ 0.08 ppm]	70D	●	●		7.0	
	80D		●		11.0	
	90D		●	●	14.5	

Space-saving design and reduced piping labor

Face-to-face dimension reduced by approx. 320 mm

AMG850 + AFF75B

AFF90D

≈ 490 mm → 170 mm

For AFF90D

The AFF series main line filter removes both water droplets and solid particles. It eliminates*¹ the need for a separate filter for removing water droplets (water separator, AMG series), thus greatly reducing the face-to-face dimension and also reducing the required installation space and piping work.

*¹ When using within the product's specification range

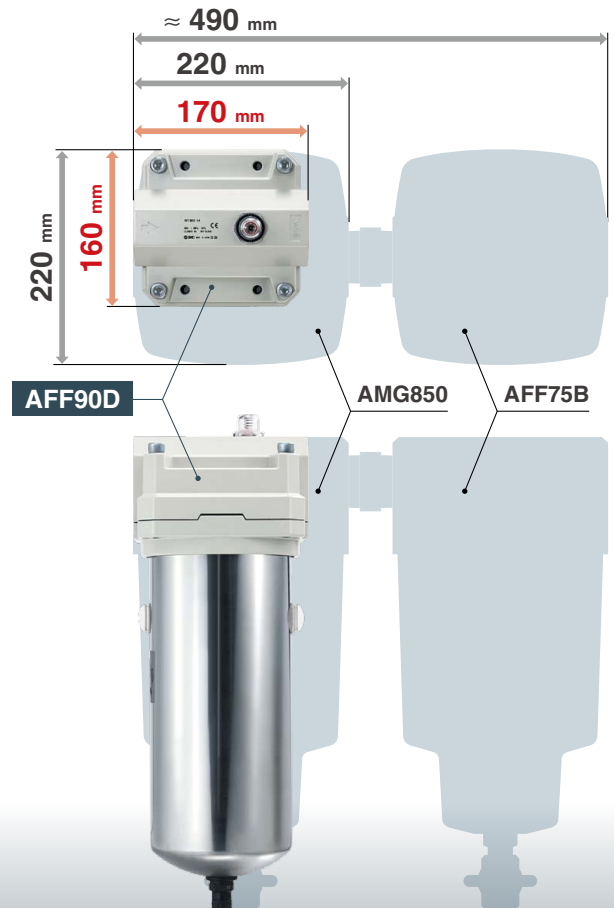

Lightweight

Lighter body weight due to thinner stainless steel bowl
Easier installation



Series	Size	Weight
AFF AM AMD	70D	3.4 kg (Existing model: 4.2 kg)
	80D	4.7 kg
	90D	5.0 kg (Existing model: 10.5 kg)

Max. 52% lighter

Increased air flow capacity due to lower pressure drop which contributes to energy saving

Flow capacity: **14.5 m³/min (ANR)**

Pressure drop: **5 kPa or less**

For AFF/AM/AMD90D

Micro mist separator **AMD** series:

Pressure drop reduced by **60%**

20% increase

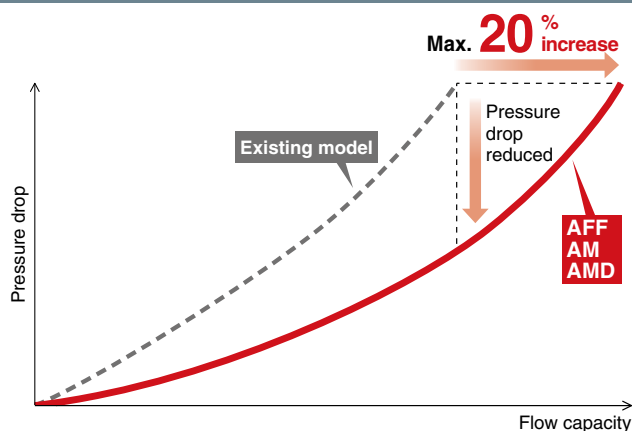

Compliant with ISO 8573 Compressed Air Purity Class

Systems which are in compliance with the degree of purity required for compressed air (For details → p. 9)

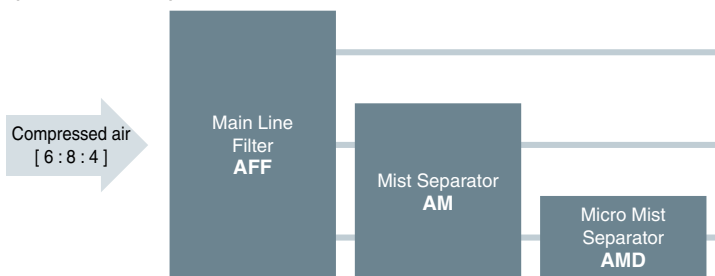

	Purity class as a system		
	Particles	Liquid water	Oil
	4	7	4
	2	7	3
	1	7	2

The class indicates the compressed air purity according to ISO 8573-1:2010 (JIS B 8392-1:2012) and indicates the maximum purity class which can be obtained using that system. Note, however, that this value will differ according to the inlet air conditions.

Certified by a third party organization

Contaminants	ISO 12500: Filters for compressed air – test methods	ISO 8573: Compressed air
Particulates	ISO 12500-3:2009 Filters for compressed air – test methods – Particulates	ISO 8573-4:2001 Compressed air – Test methods for solid particle content
Water	ISO 12500-4:2009 Filters for compressed air – test methods – Water	—
Oil aerosols	ISO 12500-1:2007 Filters for compressed air – test methods – Oil aerosols	ISO 8573-2:2007 Compressed air – Test methods for oil aerosol content



Easier replacement of the element

The stopper function prevents the bowl from falling.

The bowl will not fall even if the bolts are loosened. It is not necessary to hold the bowl when removing the bolts. Safe and secure mounting and removing of the bowl with both hands is possible. The lightweight stainless bowl with reduced thickness allows for easier element replacement.

1 Loosen the 4 securing bolts.



2 Rotate the bowl to release the stopper. Pull it down to remove the bowl.





3 At least 40 mm of maintenance space is necessary for removing the bowl.



It is possible to remove the bolts from the same direction (front).

An element service indicator is fitted as standard.

The new red ring is larger than the existing indicator, which improves visibility. The time for replacement can be checked visually.

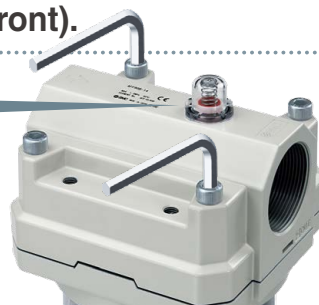

→



An end cap with slits is used for the element.

This eliminates the accumulation of condensate. Even high-velocity fluid is not spattered. The result is a compact bowl design.

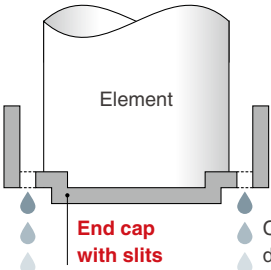
With slit



End cap with slits

Condensate discharged

Without slit

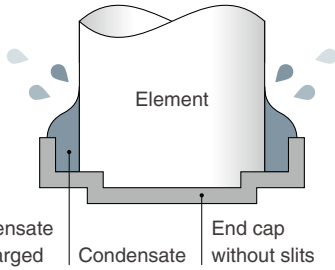

End cap without slits

Accumulated condensate flows to the downstream side.

Condensate is not accumulated, so no water flows to the downstream side.

Can be identified by color

The type of element can be identified by the color of the end cap.

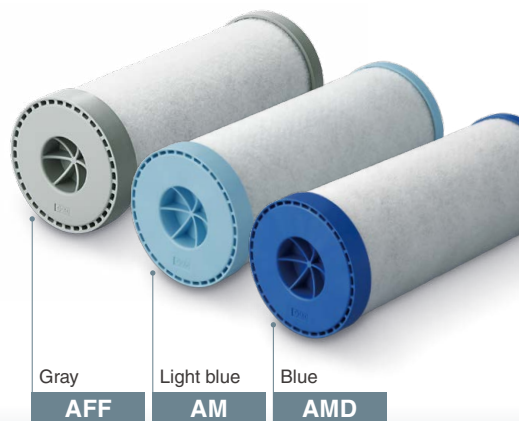

Compressed Air Preparation Filter

AFF/AM/AMD Series



How to Order

AFF 70D - 10 - -

Filter type

Symbol	Description	Specifications
AFF	Main line filter	Nominal filtration rating: 1 μm Water droplet removal ratio: 99% or more
AM	Mist separator	Nominal filtration rating: 0.1 μm Oil mist density at outlet: 1.0 mg/m ³
AMD	Micro mist separator	Nominal filtration rating: 0.01 μm Oil mist density at outlet: 0.1 mg/m ³

Symbol

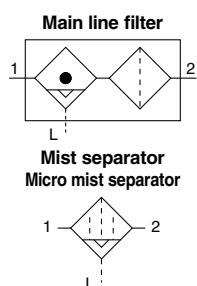

Body size

Symbol	Flow capacity
70D	7 m ³ /min (ANR)
80D	11 m ³ /min (ANR)
90D	14.5 m ³ /min (ANR)

Thread type

Symbol	Type
Nil	Rc
F	G
N	NPT

Port size

Symbol	Port size	Applicable body size		
		70D	80D	90D
10	1	●	—	—
14	1 1/2	●	●	●
20	2	—	—	●

Accessory

Symbol	Description
Nil	None
B	Bracket* ¹ , * ²

*¹ Included in the same package but not assembled (It is the customer's responsibility to assemble the product.)

*² Even when the accessory is selected, the product label does not include the accessory (body only).

Option

Symbol	Description	Max. operating pressure of the product [MPa]
Nil	Auto drain	1.0
H	Auto drain	1.6
J	Drain guide	1.6

* Options H and J cannot be selected simultaneously.

Accessory Part Nos.

Description	Model		
	70D	80D	90D
Bracket	AM-BM70D	AM-BM80D	AM-BM90D

* Includes mounting bolts (2 pcs.)

CE/UKCA-compliant

	Max. operating pressure	
	1.0 MPa	1.6 MPa
AFF/AM/AMD70D	—	—
AFF/AM/AMD80D	—	●
AFF/AM/AMD90D	●	●

Construction: AFF, AM, AMD

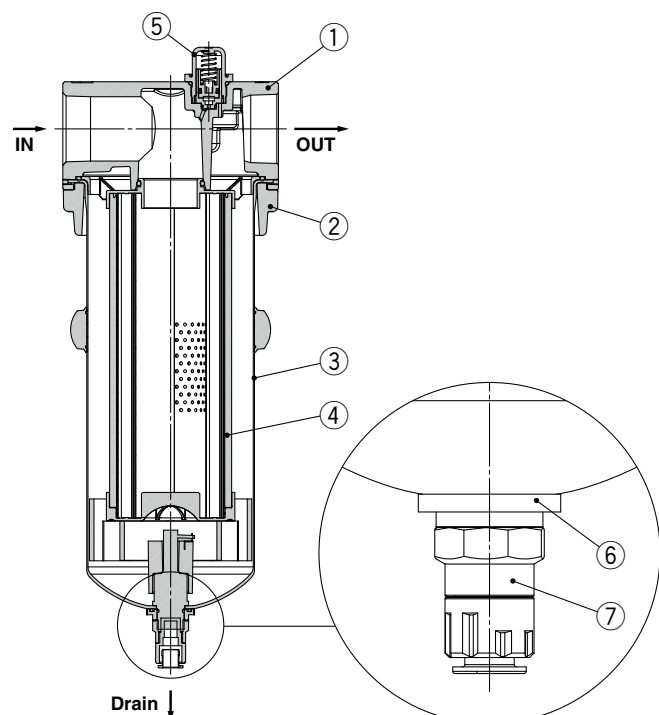

Component Parts

No.	Description	Material
1	Body	Aluminum die-cast
2	Flange	Aluminum die-cast
3	Bowl	Stainless steel

Replacement Parts

No.	Description	Order no.		
		70D	80D	90D
4	Element			
	For AFF	AFF-EL70D	AFF-EL80D	AFF-EL90D
	For AM	AM-EL70D	AM-EL80D	AM-EL90D
	For AMD	AMD-EL70D	AMD-EL80D	AMD-EL90D
5	Element service indicator	AM-SA072		
6	Drain port spacer	AM-SA075		
7	Auto drain * ¹	For Rc, G thread	AD43PA-D	
		For NPT thread	NAD43PA-D	

*¹ The -H and -J specifications cannot be replaced.

AFF/AM/AMD Series

Main Line Filter AFF Series

Standard Specifications

Model	AFF70D	AFF80D	AFF90D
Fluid	Compressed air		
Operating pressure range [MPa]	0.1 to 1.0		
Ambient and fluid temperatures [°C]	-5 to 60 (No freezing)		
Proof pressure [MPa]	1.5		
Maximum flow capacity*1 [m ³ /min (ANR)]	7.0	11.0	14.5
Inlet pressure [MPa]	0.7		
Nominal filtration rating*3 [μm]	1.0 (Filtration efficiency: 99%)		
Water droplet removal ratio*4 [%]	99		
Compressed air purity class*5	ISO 8573-1:2010 [4 : 7 : 4]*6		
Float type auto drain	N.O. (Normally open), Drain port is open when pressure is not applied.		
Port size	1 or 1 1/2	1 1/2	1 1/2 or 2
Weight [kg]	3.4	4.7	5.0
Recommended element replacement interval (Guideline)	After 2 years of operation or when the element service indicator turns red, whichever comes first.		

Maximum Flow Capacity of the Compressor Intake Condition under Rated Conditions

Model	AFF70D	AFF80D	AFF90D
Maximum flow capacity/Compressor intake condition*2 [m ³ /min]	7.3	11.5	15.1

- *1 Flow at 20°C, atmospheric pressure, and 65% of the relative humidity
- *2 32°C, flow rate when converted to atmospheric pressure
- *3 Filtration efficiency for the conditions below in addition to the rated conditions above [Test condition ISO 8573-4:2001, Test method ISO 12500-3:2009 compliant]
 - ** When the air flow capacity, inlet pressure, and the amount of solid particles on the filter inlet side are stable.
 - ** When a new element is used
- *4 Water droplet elimination rate for the conditions below in addition to the rated conditions above [Test method ISO 12500-4:2009 compliant]
 - ** Water droplet on the filter inlet side = 33 g/m³
(Water droplet indicates condensed moisture. Water vapor which is not condensed is not included.)
 - ** Inlet temperature = 25°C
 - ** When the air flow capacity, inlet pressure, and the amount of water droplets on the filter inlet side are stable.
 - ** When a new element is used
- *5 The compressed air purity class is indicated based on ISO 8573-1:2010 Compressed air – Part 1: Contaminants and purity classes. For details on this standard, refer to page 9.
- *6 The compressed air quality class on the inlet side is [6 : 8 : 4].
- * The surface finish of the outer surface of the container is equivalent to No. 2D**1.
(There may be scratches, rubbing, stains, or discoloration which do not affect the function or performance of the product.)
- **1 A symbol for the surface finish of a cold rolled stainless steel sheet defined in JIS G 4305

Flow Rate Characteristics/Select the model under the max. flow capacity line.

* Compressed air over the max. flow capacity line in the table below may not meet the specifications of the product.

AFF70D

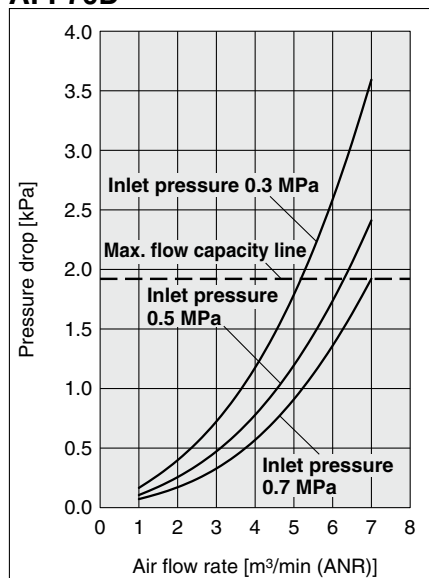

AFF80D

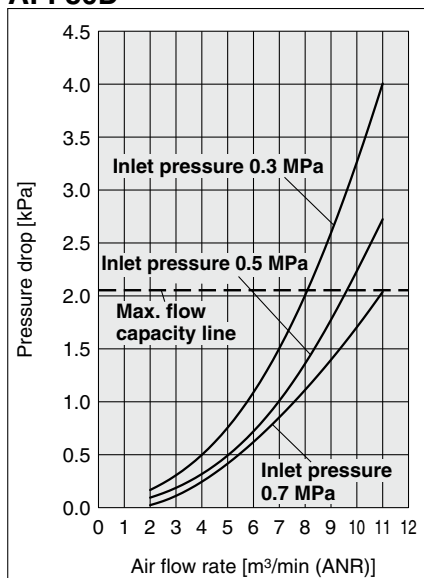

AFF90D

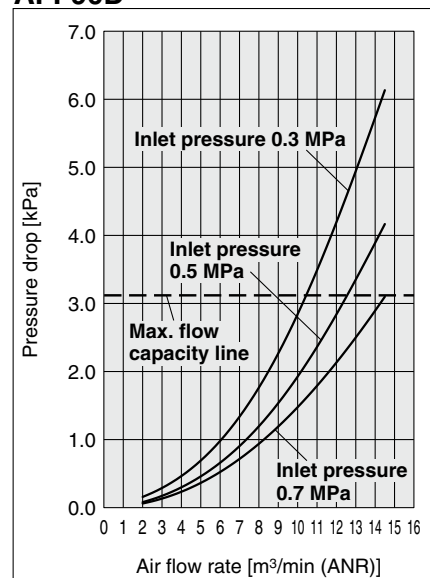

Mist Separator AM Series

Standard Specifications

Model	AM70D	AM80D	AM90D
Fluid	Compressed air		
Operating pressure range [MPa]	0.1 to 1.0		
Ambient and fluid temperatures [°C]	-5 to 60 (No freezing)		
Proof pressure [MPa]	1.5		
Maximum flow capacity*1 [m ³ /min (ANR)]	7.0	11.0	14.5
Inlet pressure [MPa]	0.7		
Nominal filtration rating*3 [µm]	0.1 (Filtration efficiency: 99%)		
Oil mist concentration on the outlet side*4 [mg/m ³ (ANR)]	1 (≈ 0.8 ppm) or less		
Compressed air purity class*5	ISO 8573-1:2010 [2 : 7 : 3]*6		
Float type auto drain	N.O. (Normally open), Drain port is open when pressure is not applied.		
Port size	1 or 1 1/2	1 1/2	1 1/2 or 2
Weight [kg]	3.4	4.7	5.0
Recommended element replacement interval (Guideline)	After 2 years of operation or when the element service indicator turns red, whichever comes first.		

Maximum Flow Capacity of the Compressor Intake Condition under Rated Conditions

Model	AM70D	AM80D	AM90D
Maximum flow capacity/Compressor intake condition*2 [m ³ /min]	7.3	11.5	15.1

- *1 Flow at 20°C, atmospheric pressure, and 65% of the relative humidity
- *2 32°C, flow rate when converted to atmospheric pressure
- *3 Filtration efficiency for the conditions below in addition to the rated conditions above [Test condition ISO 8573-4:2001, Test method ISO 12500-3:2009 compliant]
 - ** When the air flow capacity, inlet pressure, and the amount of solid particles on the filter inlet side are stable.
 - ** When a new element is used
- *4 Oil mist concentration on the outlet side for the conditions below in addition to the rated conditions above [Test condition ISO 8573-2:2007, Test method ISO 12500-1: 2007 compliant]
 - ** Oil mist concentration on the filter inlet side = 10 mg/m³
 - ** When the air flow capacity, inlet pressure, and the oil mist concentration on the filter inlet side are stable.
 - ** When a new element is used
- *5 The compressed air purity class is indicated based on ISO 8573-1:2010 Compressed air – Part 1: Contaminants and purity classes. For details on this standard, refer to page 9.
- *6 The compressed air quality class on the inlet side is [4 : 7 : 4].
 - **1 The surface finish of the outer surface of the container is equivalent to No. 2D**1.
(There may be scratches, rubbing, stains, or discoloration which do not affect the function or performance of the product.)
 - **1 A symbol for the surface finish of a cold rolled stainless steel sheet defined in JIS G 4305

Flow Rate Characteristics/Select the model under the max. flow capacity line.

* Compressed air over the max. flow capacity line in the table below may not meet the specifications of the product.

AM70D

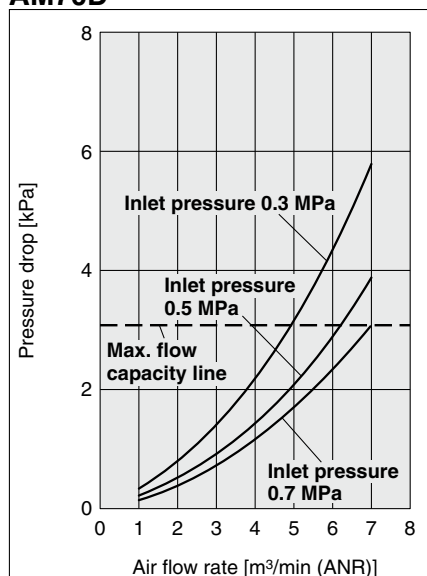

AM80D

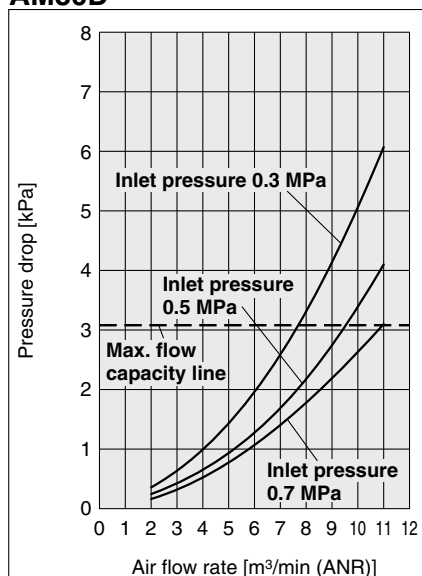

AM90D

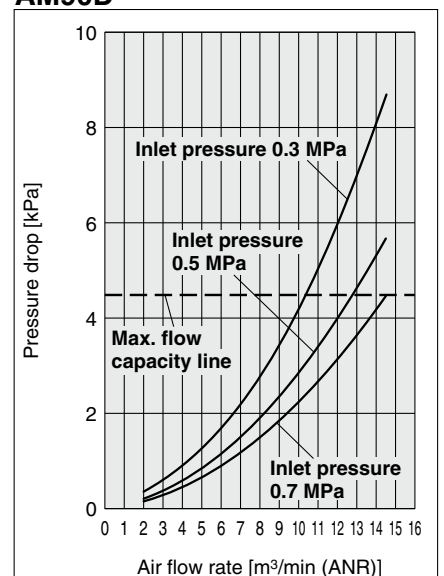

AFF/AM/AMD Series

Micro Mist Separator AMD Series

Standard Specifications

Model	AMD70D	AMD80D	AMD90D
Fluid	Compressed air		
Operating pressure range [MPa]	0.1 to 1.0		
Ambient and fluid temperatures [°C]	-5 to 60 (No freezing)		
Proof pressure [MPa]	1.5		
Maximum flow capacity*1 [m ³ /min (ANR)]	7.0	11.0	14.5
Inlet pressure [MPa]	0.7		
Nominal filtration rating*3 [μm]	0.01 (Filtration efficiency: 99.9%)		
Oil mist concentration on the outlet side*4 [mg/m ³ (ANR)]	0.1 (≈ 0.08 ppm) or less*5		
Compressed air purity class*6	ISO 8573-1:2010 [1 : 7 : 2]*7		
Float type auto drain	N.O. (Normally open), Drain port is open when pressure is not applied.		
Port size	1 or 1 1/2	1 1/2	1 1/2 or 2
Weight [kg]	3.4	4.7	5.0
Recommended element replacement interval (Guideline)	After 2 years of operation or when the element service indicator turns red, whichever comes first.		

Maximum Flow Capacity of the Compressor Intake Condition under Rated Conditions

Model	AMD70D	AMD80D	AMD90D
Maximum flow capacity/Compressor intake condition*2 [m ³ /min]	7.3	11.5	15.1

- *1 Flow at 20°C, atmospheric pressure, and 65% of the relative humidity
- *2 32°C, flow rate when converted to atmospheric pressure
- *3 Filtration efficiency for the conditions below in addition to the rated conditions above [Test condition ISO 8573-4:2001, Test method ISO 12500-3:2009 compliant]
 - ** When the air flow capacity, inlet pressure, and the amount of solid particles on the filter inlet side are stable.
 - ** When a new element is used
- *4 Oil mist concentration on the outlet side for the conditions below in addition to the rated conditions above [Test condition ISO 8573-2:2007, Test method ISO 12500-1: 2007 compliant]
 - ** Oil mist concentration on the filter inlet side = 1 mg/m³
 - ** When the air flow capacity, inlet pressure, and the oil mist concentration on the filter inlet side are stable.
 - ** When a new element is used
- *5 0.01 (≈ 0.008 ppm) or less in the initial state
- *6 The compressed air purity class is indicated based on ISO 8573-1:2010 Compressed air – Part 1: Contaminants and purity classes. For details on this standard, refer to page 9.
- *7 The compressed air quality class on the inlet side is [2 : 7 : 3].
- * The surface finish of the outer surface of the container is equivalent to No. 2D**1.
(There may be scratches, rubbing, stains, or discoloration which do not affect the function or performance of the product.)
 - **1 A symbol for the surface finish of a cold rolled stainless steel sheet defined in JIS G 4305

Flow Rate Characteristics/Select the model under the max. flow capacity line.

* Compressed air over the max. flow capacity line in the table below may not meet the specifications of the product.

AMD70D

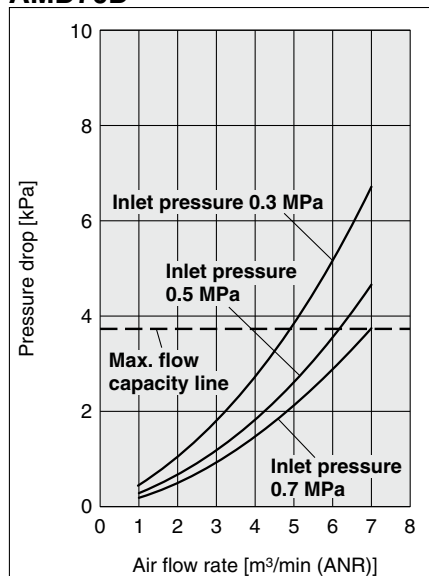

AMD80D

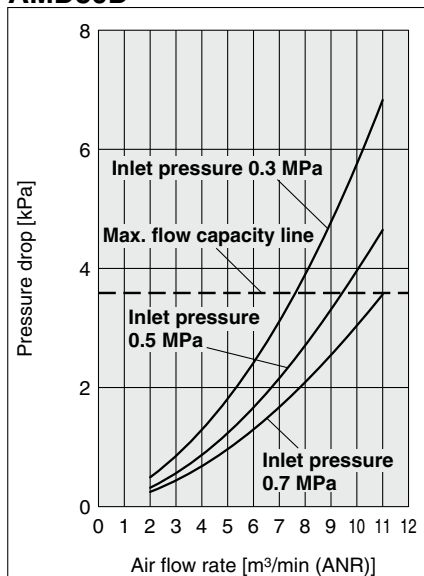

AMD90D

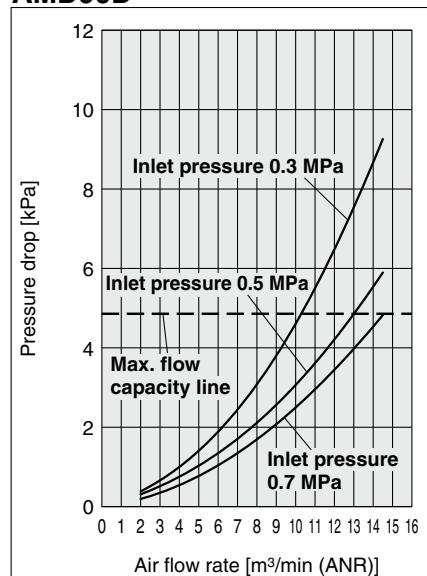

Dimensions: AFF, AM, AMD

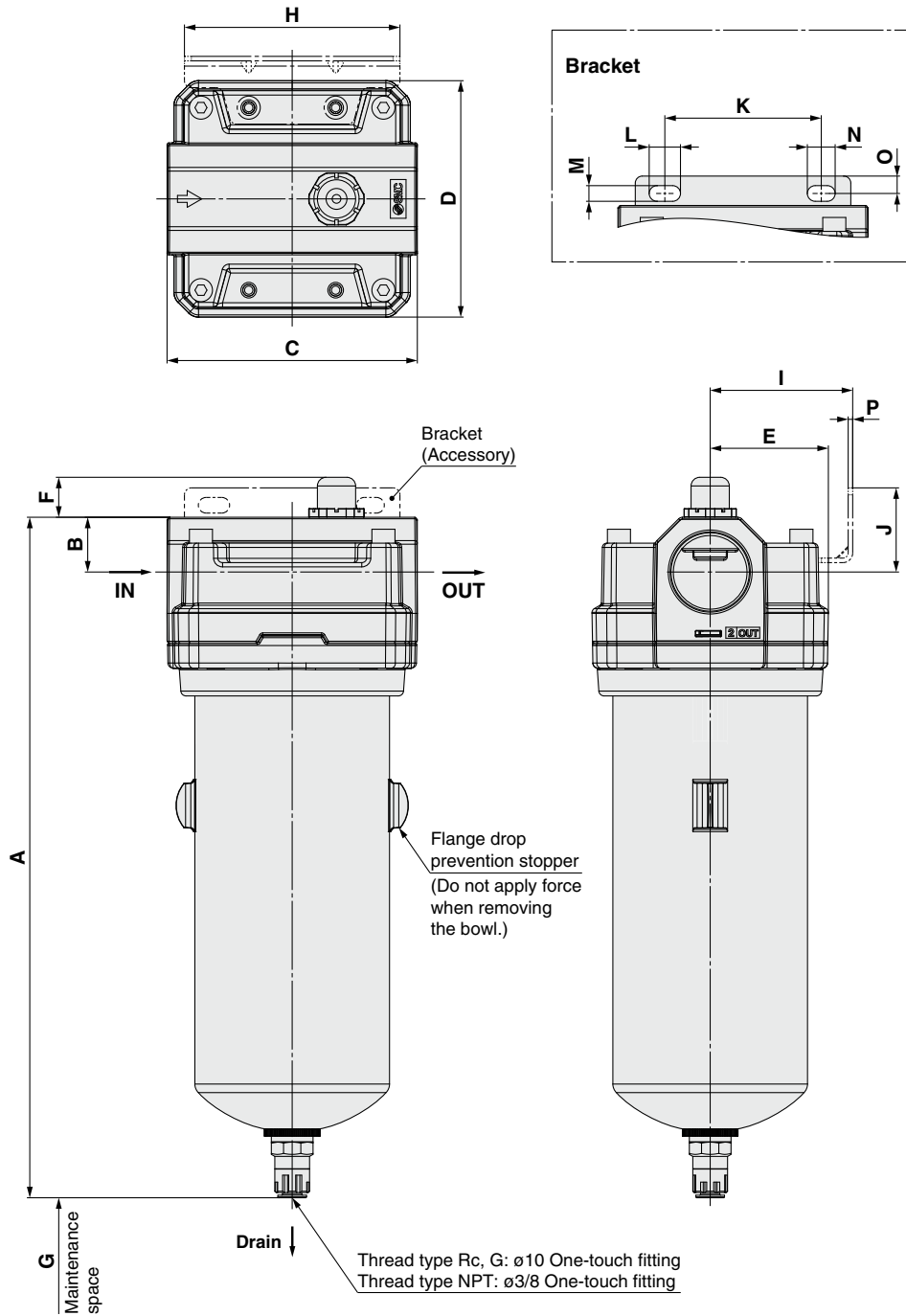

Option

H: Auto drain (1.6 MPa)

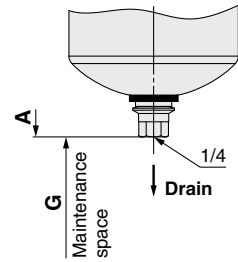

J: Drain guide

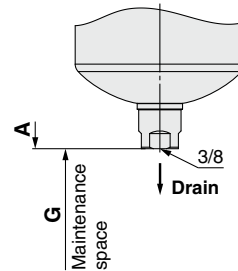

* Figures indicate the auto drain (1.0 MPa).

Dimensions

[mm]

Model	Port size	Auto drain (1.0 MPa)	Auto drain (1.6 MPa)	Drain guide	B	C	D	E	F	G	Bracket related dimensions								
											A	H	I	J	K	L	M	N	O
AFF70D, AM70D, AMD70D	1, 1 1/2	391.5	379.5	382	31.5	144	136	68	23	40	124	82	48.4	90	18	9	16	10	2.6
AFF80D, AM80D, AMD80D	1 1/2	404	392	394.5	38	170	160	80	23	40	148	93.5	58.5	110	22	11	20	12	3.2
AFF90D, AM90D, AMD90D	1 1/2, 2	470	458	460.5	38	170	160	80	23	40	148	93.5	58.5	110	22	11	20	12	3.2

International Standard ISO 8573-1:2010

Compressed Air Purity Classes

Compressed air is used in a variety of manufacturing processes. In this age, compressed air with a high degree of purity is becoming increasingly necessary.

For this reason, it is necessary to remove contaminants from systems which supply compressed air and to secure the quality. The standard which stipulates the class according to the quantities of contaminants in compressed air is ISO 8573-1.

[Outline]

Stipulates the purity class of contaminants (particles, water, oil) mixed in with the compressed air

[Scope]

Can be used in various places in compressed air systems

[Purity Classes]

Class	Particles			Mass concentration Cp [mg/m ³]	Humidity and liquid water		Oil Concentration of total oil [mg/m ³]
	Maximum number of particles per cubic meter as a function of particle size d [μm]				Pressure dew point [°C]	Concentration of liquid water Cw [g/m ³]	
	0.1 < d ≤ 0.5	0.5 < d ≤ 1.0	1.0 < d ≤ 5.0				
0	As specified by the equipment user or supplier and more stringent than class 1						
1	≤ 20000	≤ 400	≤ 10	—	≤ -70	—	≤ 0.01
2	≤ 400000	≤ 6000	≤ 100	—	≤ -40	—	≤ 0.1
3	—	≤ 90000	≤ 1000	—	≤ -20	—	≤ 1
4	—	—	≤ 10000	—	≤ +3	—	≤ 5
5	—	—	≤ 100000	—	≤ +7	—	—
6	—	—	—	0 < Cp ≤ 5	≤ +10	—	—
7	—	—	—	5 < Cp ≤ 10	—	Cw ≤ 0.5	—
8	—	—	—	—	—	0.5 < Cw ≤ 5	—
9	—	—	—	—	—	5 < Cw ≤ 10	—
x	—	—	—	Cp > 10	—	Cw > 10	> 5

[Terms and Definitions]

- Purity class: An index assigned for each classification obtained by dividing the concentration of each contaminant into ranges
- Particle: Small discrete mass of solid or liquid matter
- Humidity and liquid water: Water vapor (gas), Water droplets
- Oil: Liquid oil, Oil mist, Vapor

[How to Perform a Test to Check the Performance]

ISO 12500, which sets out the test method to be used in order to check the filter performance for each of the three kinds of contaminants, is indicated below.

- Particle: ISO 12500-3:2009
- Liquid water: ISO 12500-4:2009
- Oil: ISO 12500-1:2007

* Measured using a dedicated evaluation system which has been certified according to ISO 12500-□ and also by a third party (Certified)

[Purity Class Designation Example]

ISO 8573-1:2010 [4 : 6 : 2]

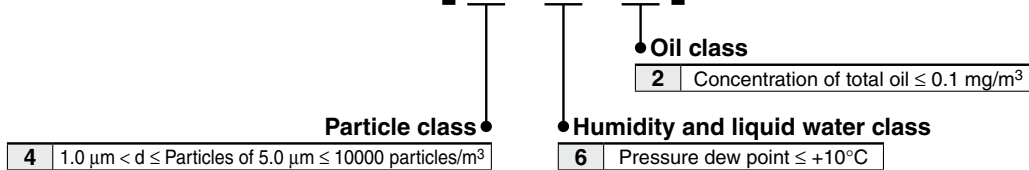

List of systems which conform to the degree of purity required for compressed air

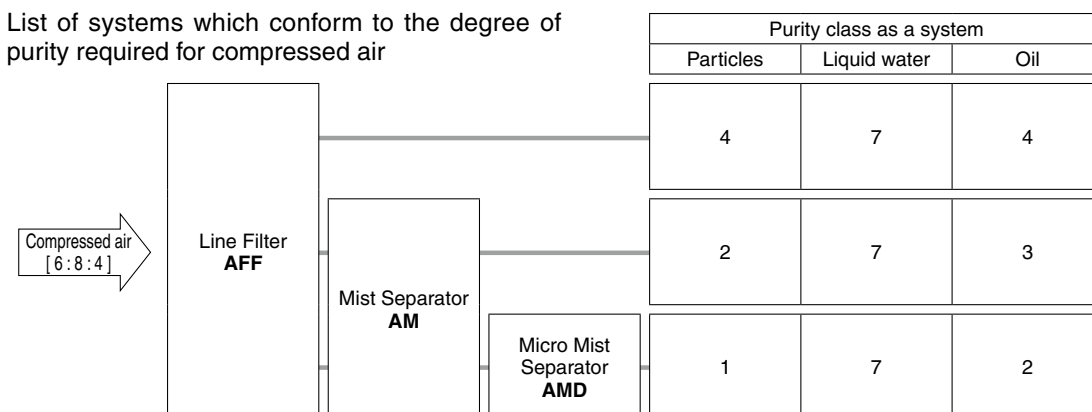

The class indicates the compressed air purity according to ISO 8573-1:2010 (JIS B 8392-1:2012) and indicates the maximum purity class which can be obtained using that system. Note, however, that this value will differ according to the inlet air conditions.



AFF/AM/AMD Series Specific Product Precautions 1

Be sure to read this before handling the products. Refer to the back cover for safety instructions. For air preparation equipment precautions, refer to the “Handling Precautions for SMC Products” and the “Operation Manual” on the SMC website: <https://www.smcworld.com>

Design

⚠ Warning

1. Hold the female thread side and tighten to the recommended torque when screwing in the piping material.

Insufficient tightening torque may cause loosening or defective sealing. Excessive tightening torque may damage the thread, etc. If it is tightened without holding the female thread side, excessive force will be directly applied to the piping bracket, resulting in a product failure.

Recommended Torque

Unit: N·m

Connection thread	1/8	1/4	3/8	1/2	3/4	1	1 1/2	2
Torque	7 to 9	12 to 14	22 to 24	28 to 30	28 to 30	36 to 38	48 to 50	48 to 50

* After tightening by hand, use a tightening tool to tighten an additional 1/6 turn.

2. Avoid excessive torsional moment or bending moment other than those caused by the equipment's own weight to the bracket, as this can cause damage. Support external piping separately.
3. Piping materials without flexibility, such as steel tube piping, are prone to be affected by excess moment loads and vibrations from the piping side. Use flexible tubing in between to avoid such effects.

⚠ Caution

1. Design the layout so that this product is installed in an area that is not susceptible to pulsations.

The element could be damaged if the difference between the inlet pressure and the outlet pressure exceeds 0.1 MPa.

2. Be careful of dust generation by the pneumatic equipment mounted on the outlet side.

When installing pneumatic equipment on the outlet side of the filter, dust particles may come off from outlet equipment, which will lower the cleanliness of the compressed air. Consider this impact upon the cleanliness of compressed air when installing pneumatic equipment on the outlet side.

3. Precautions for the use of N.O. auto drains

The valve of the N.O. auto drain does not close unless the air pressure is 0.1 MPa or more. Air may keep bleeding from the drain port if the air capacity of the compressor is small. For products with a normally closed (N.C.) auto drain, please consult SMC.

4. The auto drain has a One-touch fitting for piping. Use a tube with an O.D. of 10 mm and a length of 5 m or less for the piping of the auto drain.

5. Provide a design that prevents back pressure and backflow.

Back pressure or backflow may damage an element.

Selection

⚠ Caution

1. About the compressed air-purifying system composition

Compressed air generally contains the particulate contaminants listed below, though there are some variations due to the compressor type and specifications. Determine the system configuration according to the desired compressed air cleanliness and application while referring to the “Air Preparation Equipment Model Selection Guide” (Web Catalog).

[Particulate contaminants in compressed air]

- Moisture (water droplets, water vapor)
- Dust, chemical substances, etc., sucked from the ambient air
- Degraded oil content from the compressor (including degraded oil)
- Solid foreign matter such as rust from inside the piping and oil

2. Select according to the maximum flow rate of the system.

When compressed air is used for air blow, etc., find the maximum air consumption before selecting the size. (If compressed air exceeding the maximum flow rate is supplied, it may cause deterioration of the cleanliness of the compressed air, the outflow of oil mist on the outlet side, and also element damage.)

3. G thread specification

Not applicable for ISO 1179-1

Please consult with SMC for an applicable model.

Mounting

⚠ Caution

1. About the mounting orientation of the products

Make sure to install this product on horizontal piping. If it is installed diagonally, laterally, or upside down, the condensate separated by the element will splash to the outlet side.

Piping

⚠ Caution

1. Connect the product with the IN and OUT ports in their proper locations. It does not work with the connections reversed.

Verify the direction of the flow of the compressed air and the mark that indicates the inlet of the product before connecting. It cannot be used if connected in the opposite direction.

2. Perform air blow (flushing) sufficiently before and after piping.

Before and after piping is connected, it should be thoroughly blown out with air (flushing) or washed to remove chips, cutting oil, and other debris from inside the pipe.

3. Winding of sealant tape

When screwing piping or fittings into ports, ensure that chips from the pipe threads or sealing material do not enter the piping. Also, if sealant tape is used, leave 1.5 to 2 thread ridges exposed at the end of the threads.



AFF/AM/AMD Series

Specific Product Precautions 2

Be sure to read this before handling the products. Refer to the back cover for safety instructions. For air preparation equipment precautions, refer to the “Handling Precautions for SMC Products” and the “Operation Manual” on the SMC website: <https://www.smcworld.com>

Air Supply

⚠ Caution

- 1. This product is not applicable to gases other than compressed air.**

This product is not applicable to gases other than compressed air (example: oxygen, hydrogen, flammable gas, mixed gas).

- 2. Do not use compressed air that contains chemicals, organic solvents, salt, or corrosive gases.**

Do not use compressed gas containing chemicals, organic solvents, salt, or corrosive gas. This can cause rust, damage to rubber and resin parts, or malfunction.

- 3. Operate within the specified operating pressure range.**

Damage, failure, or malfunction may occur if this product is operated above the maximum operating pressure.

If this product is used below the minimum operating pressure, increase in the air flow resistance due to clogging will have such influence that the desired flow rate cannot be obtained.

If this product is used under a low pressure such as for a blower, conduct sufficient tests by users to confirm the specifications and performances.

Operating Environment

⚠ Caution

- 1. Do not use in the following environments, as this can cause failure.**

- 1) In locations containing corrosive gases, organic solvents, and chemical solutions, or in locations where these elements are likely to adhere to the equipment
- 2) In locations where salt water, water, or water vapor could come in contact with the equipment
- 3) In locations that are exposed to shocks and vibrations

- 2. Be careful about the contamination of the workpieces due to entrainment of the ambient air.**

If compressed air is used for air blow, compressed air blowing out from the blow nozzle may entrain foreign matter (solid particles and liquid particles) floating in the ambient air, blowing it against the workpieces and causing adhesion. Therefore, sufficient precautions must be taken about the ambient environment.

Maintenance

⚠ Caution

- 1. Replace the element with a new one when the replacement timing has come. Without replacement, the element will be damaged.**

When replacing the element, also replace the O-ring with a new one. Refer to the operation manual for replacement procedures.

<Element replacement>

When the element service indicator turns red or after 2 years of operation, whichever comes first.

Maintenance

⚠ Caution

- 2. To replace the element, make sure that the residual pressure in the filter container is zero. Replacement with residual pressure in the container may cause injury or damage of the filter.**

- 3. Be sure to discharge the condensate accumulated in the filter container.**

Failure to discharge the condensate will allow the accumulated condensate to flow over to the outlet side.

- 4. Maintenance of the auto drain**

- Auto drain usually discharges the condensate with the manual knob set to “S” side. Manual auto drain discharge is also possible.

<Manual operation>

A manual knob attached to the auto drain end is turned to the “S” side in normal operation. The condensate can be discharged by turning the knob to the “O” side. (Be careful, however, if pressure remains inside the filter when the condensate is discharged, the condensate will blow out from the drain port.)

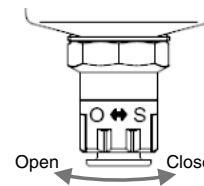

- 5. Perform periodical inspections to detect any cracks, flaws, or other deterioration of the element service indicator. Replace with a new one and review the operating conditions when any kind of the deterioration is found. Otherwise, a malfunction may occur. Please consult SMC if the review of the operating conditions is not possible.**

Others

⚠ Caution

- 1. About oil-free products**

This product includes parts (such as resin parts, rubber parts, and elements) that does not allow degreasing wash. Therefore, oil-free products with all parts degreasing washed is not available.

- 2. Degreasing wash**

Certain parts, such as the body and bowl, can be degreasing washed. Please contact SMC after confirming the specifications. (Available as a special order)

- 3. Change of oil**

Oil is used on some parts. The type of oil can be changed. (Available as a special order)

Safety Instructions

These safety instructions are intended to prevent hazardous situations and/or equipment damage. These instructions indicate the level of potential hazard with the labels of “**Caution**,” “**Warning**” or “**Danger**.” They are all important notes for safety and must be followed in addition to International Standards (ISO/IEC)*1), and other safety regulations.

 **Caution:** **Caution** indicates a hazard with a low level of risk which, if not avoided, could result in minor or moderate injury.

 **Warning:** **Warning** indicates a hazard with a medium level of risk which, if not avoided, could result in death or serious injury.

 **Danger :** **Danger** indicates a hazard with a high level of risk which, if not avoided, will result in death or serious injury.

*1) ISO 4414: Pneumatic fluid power – General rules relating to systems.
ISO 4413: Hydraulic fluid power – General rules relating to systems.
IEC 60204-1: Safety of machinery – Electrical equipment of machines.
(Part 1: General requirements)
ISO 10218-1: Manipulating industrial robots – Safety.
etc.

Warning

1. The compatibility of the product is the responsibility of the person who designs the equipment or decides its specifications.

Since the product specified here is used under various operating conditions, its compatibility with specific equipment must be decided by the person who designs the equipment or decides its specifications based on necessary analysis and test results. The expected performance and safety assurance of the equipment will be the responsibility of the person who has determined its compatibility with the product. This person should also continuously review all specifications of the product referring to its latest catalog information, with a view to giving due consideration to any possibility of equipment failure when configuring the equipment.

2. Only personnel with appropriate training should operate machinery and equipment.

The product specified here may become unsafe if handled incorrectly. The assembly, operation and maintenance of machines or equipment including our products must be performed by an operator who is appropriately trained and experienced.

3. Do not service or attempt to remove product and machinery/equipment until safety is confirmed.

1. The inspection and maintenance of machinery/equipment should only be performed after measures to prevent falling or runaway of the driven objects have been confirmed.
2. When the product is to be removed, confirm that the safety measures as mentioned above are implemented and the power from any appropriate source is cut, and read and understand the specific product precautions of all relevant products carefully.
3. Before machinery/equipment is restarted, take measures to prevent unexpected operation and malfunction.

4. Contact SMC beforehand and take special consideration of safety measures if the product is to be used in any of the following conditions.

1. Conditions and environments outside of the given specifications, or use outdoors or in a place exposed to direct sunlight.
2. Installation on equipment in conjunction with atomic energy, railways, air navigation, space, shipping, vehicles, military, medical treatment, combustion and recreation, or equipment in contact with food and beverages, emergency stop circuits, clutch and brake circuits in press applications, safety equipment or other applications unsuitable for the standard specifications described in the product catalog.
3. An application which could have negative effects on people, property, or animals requiring special safety analysis.
4. Use in an interlock circuit, which requires the provision of double interlock for possible failure by using a mechanical protective function, and periodical checks to confirm proper operation.

Caution

1. The product is provided for use in manufacturing industries.

The product herein described is basically provided for peaceful use in manufacturing industries.
If considering using the product in other industries, consult SMC beforehand and exchange specifications or a contract if necessary.
If anything is unclear, contact your nearest sales branch.

Limited warranty and Disclaimer/ Compliance Requirements

The product used is subject to the following “Limited warranty and Disclaimer” and “Compliance Requirements”.

Read and accept them before using the product.

Limited warranty and Disclaimer

1. The warranty period of the product is 1 year in service or 1.5 years after the product is delivered, whichever is first.*2)
Also, the product may have specified durability, running distance or replacement parts. Please consult your nearest sales branch.
2. For any failure or damage reported within the warranty period which is clearly our responsibility, a replacement product or necessary parts will be provided.
This limited warranty applies only to our product independently, and not to any other damage incurred due to the failure of the product.
3. Prior to using SMC products, please read and understand the warranty terms and disclaimers noted in the specified catalog for the particular products.

*2) Vacuum pads are excluded from this 1 year warranty.

A vacuum pad is a consumable part, so it is warranted for a year after it is delivered.
Also, even within the warranty period, the wear of a product due to the use of the vacuum pad or failure due to the deterioration of rubber material are not covered by the limited warranty.

Compliance Requirements

1. The use of SMC products with production equipment for the manufacture of weapons of mass destruction (WMD) or any other weapon is strictly prohibited.
2. The exports of SMC products or technology from one country to another are governed by the relevant security laws and regulations of the countries involved in the transaction. Prior to the shipment of a SMC product to another country, assure that all local rules governing that export are known and followed.

Caution

SMC products are not intended for use as instruments for legal metrology.

Measurement instruments that SMC manufactures or sells have not been qualified by type approval tests relevant to the metrology (measurement) laws of each country. Therefore, SMC products cannot be used for business or certification ordained by the metrology (measurement) laws of each country.

Revision History

Edition B * The mist separator AM series and micro mist separator AMD series have been added.

* The number of pages has been increased from 12 to 16. WQ

Edition C * The compressed air purity class indication examples have been reviewed. AV

Safety Instructions

Be sure to read the “Handling Precautions for SMC Products” (M-E03-3) and “Operation Manual” before use.

SMC Corporation

Akihabara UDX 15F,
4-14-1, Sotokanda, Chiyoda-ku, Tokyo 101-0021, JAPAN
Phone: 03-5207-8249 Fax: 03-5298-5362
<https://www.smcworld.com>
© 2022 SMC Corporation All Rights Reserved

Specifications are subject to change without prior notice and any obligation on the part of the manufacturer.

D-G