

Air Cylinder

CA2 Series

ø40, ø50, ø63, ø80, ø100

RoHS

Reduced weight by changing the shape of the rod cover and head cover.

Weight reduced by up to

(ø50-50 stroke)
15% lighter

1.31 kg

1.54 kg
Current model



Easy air cushion control

Number of cushion valve adjustment rotations increased from 1 rotation to 3 rotations. (1.5 rotations for bore size ø40)

Fine adjustment becomes easy, **ensuring smooth operation at the stroke end.**

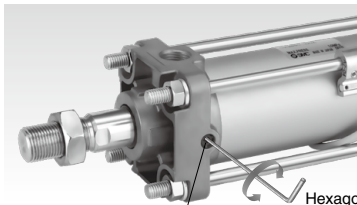

Cushion valve

Hexagon wrench

Various switches such as compact auto switches and magnetic field resistant auto switches can be mounted.

Compact auto switches

- D-M9□
- D-A9□

Magnetic field resistant auto switches

- D-P3DWA
- D-P4DW

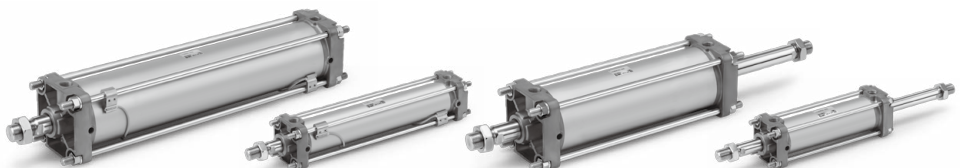
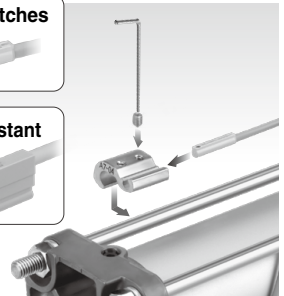

Part numbers with rod end bracket and/or pivot bracket available

Not necessary to order a bracket for the applicable cylinder separately

Note) Mounting bracket is shipped together with the product, but not assembled.

Example) CDA2 **D** 40-100Z- **N W** -M9BW

• Mounting

Pivot bracket

Nil	None
N	Pivot bracket is shipped together with the product, but not assembled.

* Applicable to only mounting D (Double clevis) and T (Center trunnion).

N: Kit of pivot bracket and double clevis



T: Kit of pivot bracket and trunnion



Rod end bracket

Nil	None
V	Single knuckle joint
W	Double knuckle joint

With rod end bracket

V: Single knuckle joint **W:** Double knuckle joint



Various mounting bracket options

- Suitable mounting brackets can be selected for the installation condition.
- Improved amount of mounting freedom

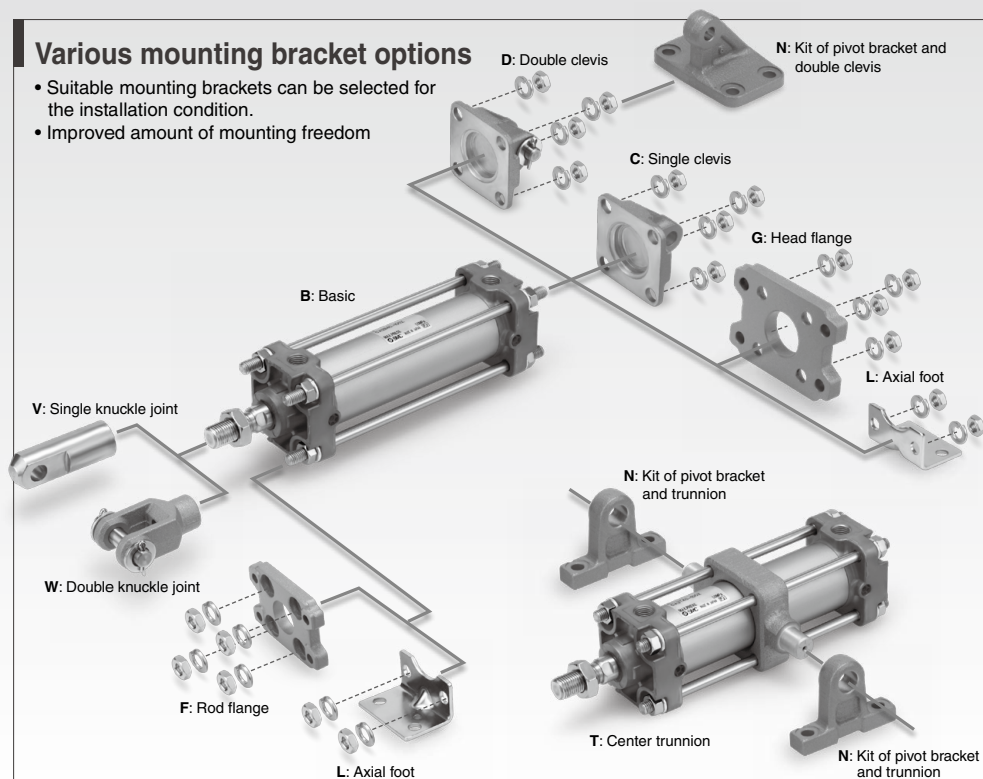

Reduced weight by changing the shape of the rod cover and head cover.

Bore size (mm)	CA2	Reduction rate	Current model (kg)
40	0.93	12%	1.06
50	1.31	15%	1.54
63	1.84	14%	2.15
80	3.17	11%	3.56
100	4.29	10%	4.76

* Compared to 50 stroke for each size

No substances hazardous to the environment are used.

Lead free bushing is used as sliding material. Compliant with EU RoHS directive.

Mounting dimensions are equivalent to the existing CA2 series.

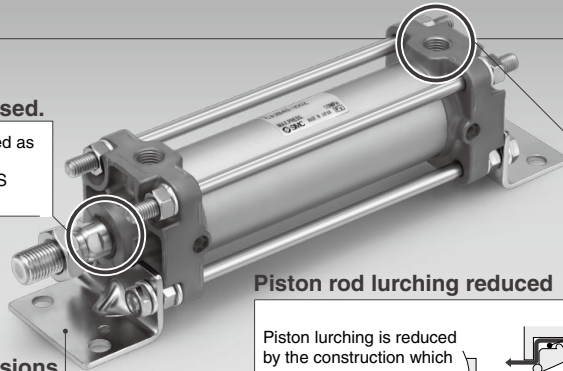

Piston rod lurching reduced

Piston lurching is reduced by the construction which minimizes resistance in the air passage at startup.

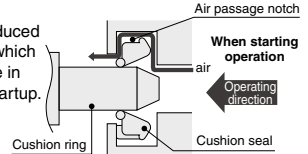

Stroke Variations

Bore size (mm)	Standard stroke																
	25	50	75	100	125	150	175	200	250	300	350	400	450	500	600	700	Up to 1800
40	●	●	●	●	●	●	●	●	●	●	●	●	●	●	●		
50	●	●	●	●	●	●	●	●	●	●	●	●	●	●	●		
63	●	●	●	●	●	●	●	●	●	●	●	●	●	●	●		
80	●	●	●	●	●	●	●	●	●	●	●	●	●	●	●	●	
100	●	●	●	●	●	●	●	●	●	●	●	●	●	●	●	●	●

Series Variations

Series	Type	Bore size (mm)					Variations		Page
		40	50	63	80	100	With rod boot	Water resistant	
Standard 	CA2-Z Single rod	●	●	●	●	●	●	●	Page 560
	Double rod	●	●	●	●	●	●	●	
Non-rotating rod 	CA2K Single rod	●	●	●	●	●	●	●	Page 584
	Double rod	●	●	●	●	●	●	●	Page 588
With end lock 	CBA2 Single rod	●	●	●	●	●	●	●	Page 592
Air-hydro 	CA2□H Single rod	●	●	●	●	●	●	●	Page 598
	Double rod	●	●	●	●	●	●	●	Page 602
Smooth Cylinder 	CA2Y-Z Single rod	●	●	●	●	●	●	●	Web Catalog

* For details about the clean series, refer to the [Web Catalog](#).

Combinations of Standard Products and Made to Order Specifications

CA2 Series

- : Standard
- ⊙ : Made to Order
- : Special product (Please contact SMC for details.)
- : Not available

Symbol	Specifications	Applicable bore size	Series		CA2 (Standard type)		CA2K ^{Note 4)} (Non-rotating rod type)		
			Action/Type	Page	Double acting				
					Single rod	Double rod	Single rod	Double rod	
			Page 560	Page 576	Page 584	Page 588			
Standard	Standard		—						
CDA2-□Z	Built-in magnet	ø40 to ø100	●	●	●	●			
Long st	Long stroke		●	●	○	○			
CA2□-□JZ	With rod boot (Nylon tarpaulin)		●	●	●	○			
CA2□-□KZ	With rod boot (Heat resistant tarpaulin)		●	●	●	○			
10-, 11-	Clean series ^{Note 4)}		●	○	—	—			
25A-	Series compatible with secondary batteries (Copper (Cu) and Zinc (Zn) restrictions) ^{Note 1)}	ø40 to ø100	●	○	—	—			
20-	Copper and fluorine-free specification (Copper ^{Note 2)} and fluorine-free)		●	●	●	●			
CA2□R	Water resistant (NBR seal)	ø40 to ø100	●	○	—	—			
CA2□V	Water resistant (FKM seal)		●	○	—	—			
CA2□M	Cylinder with stable lubrication function (Lube-retainer)		●	○	—	—			
XA□	Change of rod end shape	ø40 to ø100	⊙	⊙	⊙	○			
XB5	Oversized rod cylinder ^{Note 4)}		⊙	○	—	—			
XB6	Heat resistant cylinder (-10 to 150°C)		⊙	○	—	—			
XC3	Special port location ^{Note 4)}		⊙	⊙	○	○			
XC4	With heavy duty scraper		⊙	⊙	—	—			
XC5	Heat resistant cylinder (-10 to 110°C)		⊙	⊙	—	—			
XC6	Made of stainless steel ^{Note 4)}		—	—	—	—			
XC7	Tie-rod, cushion valve, tie-rod nut, etc. made of stainless steel		⊙	⊙	⊙	⊙			
XC8	Adjustable stroke cylinder/Adjustable extension type		⊙	—	⊙	—			
XC9	Adjustable stroke cylinder/Adjustable retraction type		⊙	—	⊙	—			
XC10	Dual stroke cylinder/Double rod type		⊙	—	⊙	—			
XC11	Dual stroke cylinder/Single rod type		⊙	○	⊙	—			
XC12	Tandem cylinder		⊙	○	⊙	—			
XC14	Change of trunnion bracket mounting position		⊙	⊙	⊙	⊙			
XC15	Change of tie-rod length		⊙	⊙	⊙	⊙			
XC22	Fluororubber seal		⊙	⊙	—	—			
XC27	Double clevis and double knuckle joint pins made of stainless steel		⊙	—	⊙	—			
XC28	Compact flange made of SS400	⊙	⊙	⊙	⊙				
XC29	Double knuckle joint with spring pin	⊙	○	○	○				
XC30	Rod trunnion	⊙	○	○	○				
XC35	With coil scraper	⊙	⊙	—	—				
XC65	Made of stainless steel (Combination of XC7 and XC68)	⊙	⊙	—	—				
XC68	Made of stainless steel (with hard chrome plated piston rod)	⊙	⊙	—	—				
XC85	Grease for food processing equipment	⊙	⊙	○	○				
XC88	Spatter resistant coil scraper, Lube-retainer, Grease for welding (Piston rod: Stainless steel 304)	⊙	○	—	—				
XC89	Spatter resistant coil scraper, Lube-retainer, Grease for welding (Piston rod: S45C)	⊙	○	—	—				
XC91	Spatter resistant coil scraper, Grease for welding (Piston rod: S45C)	⊙	○	—	—				
X1184	Cylinder with heat resistant reed auto switch (-10 to 120°C)	⊙	⊙	—	—				

Note 1) For details, refer to the [Web Catalog](#).
 Note 2) Copper-free for the externally exposed part. For details, refer to the [Web Catalog](#).
 Note 3) For details about the smooth cylinder, refer to the [Web Catalog](#).
 Note 4) The cover shape and model are the same as those of the existing CA2 series product.

CBA2 <small>Note 4)</small> (With end lock)	CA2□H <small>Note 4)</small> (Air-hydro type)	CA2Y <small>Note 3)</small> (Smooth Cylinder)	Double acting	
Single rod	Single rod	Double rod	Single rod	
Page 592	Page 598	Page 602	Web Catalog	
—				Symbol
●	●	●	●	Standard
●	●	●	●	CDA2-□Z
●	●	●	○	Long st
●	●	●	○	CA2□-□JZ
●	●	●	○	CA2□-□KZ
● <small>Note 5)</small>	—	—	○	10-, 11-
—	—	—	○	25A-
●	○	○	○	20-
● <small>Note 5)</small>	○	○	—	CA2□R
● <small>Note 5)</small>	○	○	—	CA2□V
○	—	—	—	CA2□M
⊙	⊙	○	⊙	XA□
○	○	○	—	XB5
⊙	—	—	—	XB6
⊙	○	○	—	XC3
⊙ <small>Note 5)</small>	⊙ <small>Note 7)</small>	⊙ <small>Note 7)</small>	—	XC4
○	—	—	—	XC5
⊙ <small>Note 5)</small>	⊙	⊙	—	XC6
⊙	⊙	⊙	⊙	XC7
⊙ <small>Note 5)</small>	○	—	○	XC8
⊙ <small>Note 6)</small>	○	—	○	XC9
⊙	○	—	○	XC10
○	○	○	○	XC11
○	○	○	—	XC12
⊙	⊙	⊙	⊙	XC14
⊙	⊙	⊙	⊙	XC15
⊙	○	○	—	XC22
⊙	⊙	—	⊙	XC27
⊙	⊙	⊙	⊙	XC28
⊙	⊙	○	⊙	XC29
⊙ <small>Note 5)</small>	○	○	⊙	XC30
⊙	○	○	—	XC35
○	⊙	⊙	⊙	XC65
○	○	○	⊙	XC68
○	—	—	—	XC85
○	—	—	—	XC88
○	—	—	—	XC89
○	—	—	—	XC91
○	—	—	—	X1184

Note 5) Available only for locking at head end.

Note 6) Available only for locking at rod end.

Note 7) Standard for the air-hydro type

Note 8) CA2□Q series has no cushion. Only XC3BC, XC3CD and XC3DA are available.

Air Cylinder: Standard Type Double Acting, Single Rod

CA2 Series

ø40, ø50, ø63, ø80, ø100

RoHS

How to Order

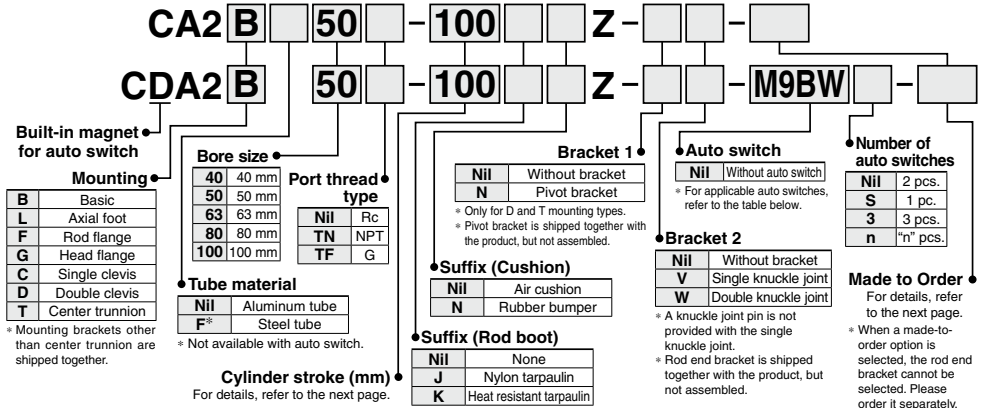

Applicable Auto Switches/Refer to pages 1271 to 1365 for further information on auto switches.

Type	Special function	Electrical entry	Indicator (opt)	Wiring (Output)	Load voltage		Auto switch model		Lead wire length (m)			Pre-wired connector	Applicable load								
					DC	AC	Tie-rod mounting	Band mounting	0.5 (Nil)	1 (M)	3 (L)			5 (Z)							
Solid state auto switch	—	Grommet	—	3-wire (NPN)	24 V	5 V, 12 V	—	M9N	●	●	○	○	IC circuit	—							
				3-wire (PNP)				G59	●	●	○	○									
				2-wire				M9P	●	●	○	○									
		Terminal conduit		3-wire (NPN)				G5P	●	●	○	○									
				2-wire				M9B	●	●	○	○									
				3-wire (NPN)				K59	●	●	○	○									
	Diagnostic indication (2-color indicator)	Grommet	Yes	3-wire (NPN)	24 V	5 V, 12 V	—	G39C	●	●	○	○	IC circuit	Relay, PLC							
				3-wire (PNP)				G39	●	●	○	○									
				2-wire				K39C	●	●	○	○									
		Terminal conduit		3-wire (NPN)				M9NW	●	●	○	○									
				2-wire				G59W	●	●	○	○									
				3-wire (PNP)				M9PW	●	●	○	○									
Water resistant (2-color indicator)	Grommet	—	3-wire (NPN)	24 V	5 V, 12 V	—	M9BA*1	●	●	○	○	—	—								
			3-wire (PNP)				G59W	●	●	○	○										
			2-wire				M9PW	●	●	○	○										
	Terminal conduit		3-wire (NPN)				G59W	●	●	○	○										
			2-wire				M9BW	●	●	○	○										
			3-wire (PNP)				K59W	●	●	○	○										
With diagnostic output (2-color indicator)	Grommet	—	4-wire (NPN)	24 V	5 V, 12 V	—	M9NA*1	○	○	○	○	IC circuit	—								
			2-wire				M9PA*1	○	○	○	○										
			3-wire (PNP)				M9BA*1	○	○	○	○										
	Terminal conduit		4-wire (NPN)				G59F	●	●	○	○										
			2-wire				P3DWA	●	●	○	○										
			3-wire (Non-polar)				P4DW	●	●	○	○										
Reed auto switch	—	Grommet	Yes	3-wire (NPN equivalent)	24 V	5 V	—	A96	●	●	○	○	IC circuit	—							
				Terminal conduit				100 V	A93	●	●	○			○						
								100 V or less	A90	●	●	○			○						
								100 V, 200 V	A54	B54	●	●			○	○					
				DIN terminal				200 V or less	A64	B64	●	●			○	○					
								Grommet	2-wire	A33C	A33	—			—	—	—				
		3-wire (NPN)							A34C	A34	—	—	—	—							
		Diagnostic indication (2-color indicator)		Grommet					Yes	100 V, 200 V	24 V	12 V	—	A44C	A44	—	—	—	—	—	Relay, PLC
								Terminal conduit		2-wire				A59W	B59W	●	●	○	○		
										DIN terminal				3-wire (NPN)	A96	●	●	○	○		
				100 V										A93	●	●	○	○			
				100 V or less				A90						●	●	○	○				
100 V, 200 V	A54		B54	●	●	○	○														
200 V or less	A64	B64	●	●	○	○															
2-wire	A33C	A33	—	—	—	—															
3-wire (NPN)	A34C	A34	—	—	—	—															
100 V, 200 V	A44C	A44	—	—	—	—															
2-wire	A59W	B59W	●	●	○	○															

*1 Water resistant type auto switches can be mounted on the above models, but in such case SMC cannot guarantee water resistance.
* A water-resistant type cylinder is recommended for use in an environment which requires water resistance.
* Lead wire length symbols: 0.5 m..... Nil (Example) M9NW * Solid state auto switches marked with "○" are produced upon receipt of order.
1 m..... M (Example) M9NWM
3 m..... L (Example) M9NWL
5 m..... Z (Example) M9NWX

* Since there are other applicable auto switches than listed above, refer to page 613 for details.
* For details about auto switches with pre-wired connector, refer to pages 1340 and 1341.
* The D-A9□/M9□□/P3DWA□ auto switches are shipped together, (but not assembled). (However, auto switch mounting brackets are assembled for the D-A9□/M9□□ before shipment.)



Specifications



Symbol

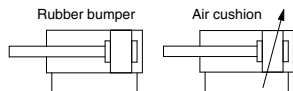

Made to Order
Made to Order: Individual Specifications
 (For details, refer to page 614.)

Symbol	Specifications
-X1184	Cylinder with heat resistant reed auto switch (-10 to 120°C)

Made to Order

[Click here for details](#)

Symbol	Specifications
-XA□	Change of rod end shape
-XB5	Oversized rod cylinder*
-XB6	Heat resistant cylinder (-10 to 150°C)
-XC3	Special port location*
-XC4	With heavy duty scraper
-XC5	Heat resistant cylinder (-10 to 110°C)
-XC7	Tie-rod, cushion valve, tie-rod nut, etc. made of stainless steel
-XC8	Adjustable stroke cylinder/Adjustable extension type
-XC9	Adjustable stroke cylinder/Adjustable retraction type
-XC10	Dual stroke cylinder/Double rod type
-XC11	Dual stroke cylinder/Single rod type
-XC12	Tandem cylinder
-XC14	Change of trunnion bracket mounting position
-XC15	Change of tie-rod length
-XC22	Fluororubber seal
-XC27	Double clevis and double knuckle joint pins made of stainless steel
-XC28	Compact flange made of SS400
-XC29	Double knuckle joint with spring pin
-XC30	Rod trunnion
-XC35	With coil scraper
-XC65	Made of stainless steel (Combination of XC7 and XC68)
-XC68	Made of stainless steel (with hard chrome plated piston rod)
-XC85	Grease for food processing equipment
-XC88	Spatter resistant coil scraper, Lube-retainer, Grease for welding (Piston rod: Stainless steel 304)
-XC89	Spatter resistant coil scraper, Lube-retainer, Grease for welding (Piston rod: S45C)
-XC91	Spatter resistant coil scraper, Grease for welding (Piston rod: S45C)

For special port location (-XC3), the mounting bracket and port location can be determined using the standard product corresponding to the operating conditions.

* The cover shape and model are the same as those of the existing CA2 series product.

Refer to pages 607 to 613 for cylinders with auto switches.
• Auto switch proper mounting position (detection at stroke end) and its mounting height
• Operating range
• Minimum stroke for auto switch mounting
• Auto switch mounting brackets/Part no.

Bore size (mm)		40	50	63	80	100
Fluid		Air				
Action		Double acting				
Proof pressure		1.5 MPa				
Maximum operating pressure		1.0 MPa				
Ambient and fluid temperature		Without auto switch magnet : -10 to 70°C ^{*1} Built-in magnet for auto switch: -10 to 60°C ^{*1}				
Minimum operating pressure		0.05 MPa				
Piston speed		50 to 500 mm/s				
Cushion		Air cushion or Rubber bumper				
Stroke length tolerance		Up to 250 st: ^{+1.0} / ₀ 251 to 1000 st: ^{+1.4} / ₀ 1001 to 1500 st: ^{+1.8} / ₀ 1501 to 1800 st: ^{+2.2} / ₀				
Lubrication		Not required (Non-lube)				
Mounting		Basic, Foot, Rod flange, Head flange Single clevis, Double clevis, Center trunnion				
Allowable kinetic energy (J)^{*2}	Air cushion	2.8	4.6	7.8	16	29
	When not activated	0.33	0.56	0.91	1.5	2.68
	Rubber bumper	1.8	3.6	6.0	12.0	12.0

*1 No freezing

*2 Activate the air cushion when operating the cylinder. If this is not done, the piston rod assembly or the tie-rods will be damaged when the allowable kinetic energy exceeds the values shown in the above table.

Standard Strokes

Bore size	Standard stroke		Stroke range <small>Note 3)</small> (mm)
40	25, 50, 75, 100, 125, 150, 175, 200, 250, 300, 350, 400, 450, 500		1 to 1800
	25, 50, 75, 100, 125, 150, 175, 200, 250, 300, 350, 400, 450, 500, 600		
80, 100	25, 50, 75, 100, 125, 150, 175, 200, 250, 300, 350, 400, 450, 500, 600, 700		

Note 1) Aside from the standard strokes, intermediate strokes (within stroke range) are also available in 1 mm increments and are produced upon receipt of order.

Note 2) Applicable strokes should be confirmed according to the usage. For details, refer to "Air Cylinders Model Selection" on front matter pages. In addition, the products that exceed the standard stroke might not be able to fulfill the specifications due to the deflection etc. Strokes which exceed the standard stroke length will be available as special order.

Note 3) The stroke range for the type with a rod boot is shown in the table below. Strokes exceeding those in the table below are only available as a special order.

Bore size	Stroke range (mm)	
	Air cushion	Rubber bumper
40 to 100	20 to 1800	20 to 1400

Minimum Stroke for Auto Switch Mounting

⚠ Caution

The minimum stroke for mounting varies with the auto switch type and cylinder mounting type. In particular, the center trunnion type needs careful attention. (For details, refer to pages 611 and 612.)

Rod Boot Material

Symbol	Rod boot material	Max. ambient temperature
J	Nylon tarpaulin	70°C
K	Heat resistant tarpaulin	110°C*

* Maximum ambient temperature for the rod boot

* The rod boot replacement part numbers are listed in the "Maintenance Parts List." [Click here](#) for further details.

Accessories

	Mounting	Basic	Axial foot	Rod flange	Head flange	Single clevis	Double clevis	Center trunnion
Standard	Rod end nut	●	●	●	●	●	●	●
	Clevis pin	—	—	—	—	—	●	—
Option	Single knuckle joint	●	●	●	●	●	●	●
	Double knuckle joint (with pin)	●	●	●	●	●	●	●
	With rod boot	●	●	●	●	●	●	●

* Refer to page 575 for part numbers and dimensions.

CA2 Series

Ordering Example of Cylinder Assembly

Cylinder model:
CDA2D50-100Z-NW-M9BW

Mounting **D: Double clevis**
Pivot bracket **N: Yes**
Rod end bracket **W: Double knuckle joint**
Auto switch **D-M9BW: 2 pcs.**

* Pivot bracket, double knuckle joint and auto switch are shipped together with the product, but not assembled.

Mounting Brackets/Part No.

Bore size (mm)	40	50	63	80	100
Axial foot*	CA2-L04	CA2-L05	CA2-L06	CA2-L08	CA2-L10
Flange	CA2-F04	CA2-F05	CA2-F06	CA2-F08	CA2-F10
Single clevis	CA2-C04	CA2-C05	CA2-C06	CA2-C08	CA2-C10
Double clevis**	CA2-D04	CA2-D05	CA2-D06	CA2-D08	CA2-D10
Flange (With rod boot)	CA2-F04-J	CA2-F05-J	CA2-F06-J	CA2-F08-J	CA2-F10-J
Flange (For long)	—	CA2-F05-L	CA2-F06-L	CA2-F08-L	CA2-F10-L
Flange (With long rod boot)	—	CA2-F05-LJ	CA2-F06-LJ	CA2-F08-LJ	CA2-F10-LJ

* When axial foot brackets are used, order two pieces per cylinder.

** A clevis pin, flat washers and split pins are shipped together with double clevis.

Weights/Aluminum Tube (Steel Tube)

Bore size (mm)		40	50	63	80	100		
Basic weight	Basic	Aluminum tube	0.73	1.06	1.53	2.73	3.71	
		Steel tube	0.78	1.12	1.62	2.91	3.98	
	Axial foot	Aluminum tube	0.91	1.25	1.83	3.40	4.64	
		Steel tube	0.96	1.31	1.92	3.58	4.91	
	Flange	Aluminum tube	1.09	1.48	2.28	4.18	5.57	
		Steel tube	1.14	1.54	2.37	4.36	5.84	
	Single clevis	Aluminum tube	0.95	1.37	2.12	3.84	5.43	
		Steel tube	1.00	1.43	2.21	4.02	5.70	
	Double clevis	Aluminum tube	0.99	1.46	2.28	4.13	5.95	
		Steel tube	1.04	1.52	2.37	4.31	6.22	
	Trunnion	Aluminum tube	1.08	1.51	2.29	4.28	5.93	
		Steel tube	1.13	1.57	2.38	4.46	6.20	
	Additional weight per 50 mm of stroke	All mounting brackets	Aluminum tube	0.20	0.25	0.31	0.46	0.58
			Steel tube	0.28	0.35	0.43	0.7	0.87
Accessories	Single knuckle	0.23	0.26	0.26	0.60	0.83		
	Double knuckle (with pin)	0.37	0.43	0.43	0.87	1.27		

Calculation:
 Example) **CA2L40-100Z**
 (Axial foot, ø40, 100 stroke)

- Basic weight.....0.91 kg
- Additional weight.....0.20/50 stroke
- Cylinder stroke 100 stroke

$$0.91 + 0.20 \times 100/50 = 1.31 \text{ kg}$$

Allowable Kinetic Energy

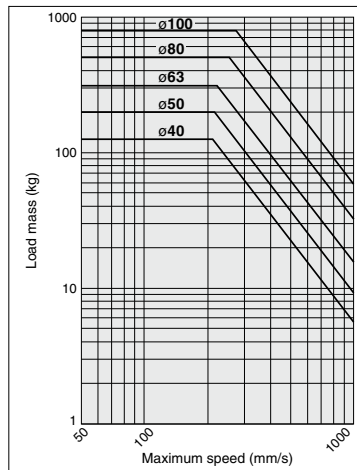

(Example) Find the upper limit of rod end load when an air cylinder of ø63 is operated at 500 mm/s.

From a point indicating 500 mm/s on the axis of abscissas, extend a line upward and find a point where it intersects with a line for the 63 mm bore size. Extend a line from the intersection to the left and find a load mass 60 kg.

Water Resistant

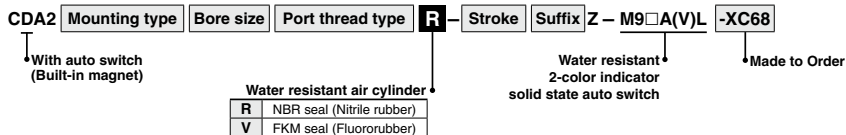

Specifications

Action	Double acting, Single rod
Bore size (mm)	40, 50, 63, 80, 100
Cushion	Air cushion
Auto switch mounting	Tie-rod mounting
Made to Order	XC68: Made of stainless steel (with hard chrome plated piston rod)

* Specifications other than the above are the same as the standard basic type.
Note 1) Excluding the air-hydro type and the type with a rod boot of the CA2 series.
Note 2) Combination of auto switches and steel tube is not available.
For details, refer to page 1189.

Dimensions

* The dimensions are the same as the standard double acting, single rod type. Refer to page 565 for details.

Cylinder with Stable Lubrication Function (Lube-retainer)

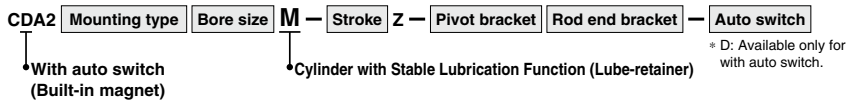

Specifications

Bore size (mm)	40, 50, 63, 80, 100
Action	Double acting, Single rod
Minimum operating pressure	0.1 MPa
Piston speed	50 to 500 mm/s
Cushion	Air cushion

* Specifications other than the above are the same as the standard type.

Dimensions (Dimensions other than those shown below are the same as the standard type.)

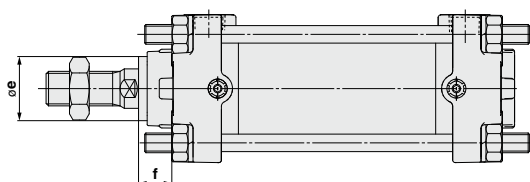

Bore size	(mm)	
	øe	f
40	26	13.5
50	30	12.5
63	30	12.5
80	36	16.5
100	42	16

* The mounting dimensions of the mounting bracket are the same as the standard type.

For details, refer to page 1204.

CA2 Series

Construction

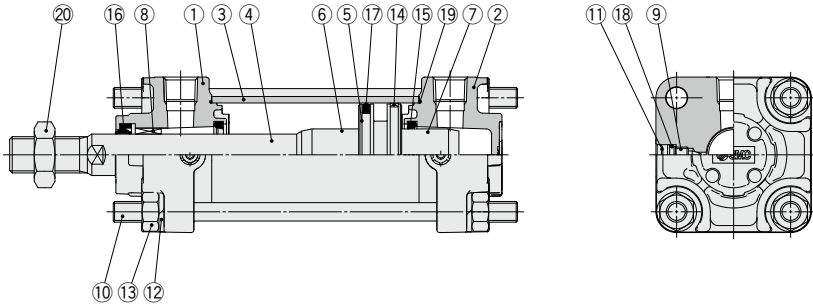

Component Parts

No.	Description	Material	Note
1	Rod cover	Aluminum die-casted	Trivalent chromated
2	Head cover	Aluminum die-casted	Trivalent chromated
3	Cylinder tube	Aluminum alloy	Hard anodized
4	Piston rod	Carbon steel	Hard chrome plating
5	Piston	Aluminum alloy	
6	Cushion ring	Aluminum alloy	Anodized
7	Cushion ring B	Aluminum alloy	Anodized
8	Bushing	Bearing alloy	
9	Cushion valve	Steel wire	Trivalent zinc chromated
10	Tie-rod	Carbon steel	Trivalent zinc chromated
11	Retaining ring	Spring steel	Phosphate coating
12	Spring washer	Steel wire	Trivalent zinc chromated
13	Tie-rod nut	Rolled steel	Trivalent zinc chromated
14	Wear ring	Resin	
15	Cushion seal	Urethane	
16	Rod seal	NBR	
17	Piston seal	NBR	
18	Cushion valve seal	NBR	
19	Cylinder tube gasket	NBR	
20	Rod end nut	Rolled steel	Trivalent zinc chromated

Replacement Parts: Seal Kit

Bore size (mm)	Kit no.	Contents
40	CA2-40Z-PS	Set of the nos. 15, 16, 17, 19
50	CA2-50Z-PS	
63	CA2-63Z-PS	
80	CA2-80Z-PS	
100	CA2-100Z-PS	

- * Seal kit includes 15, 16, 17, 19. Order the seal kit based on each bore size.
- * Do not disassemble the trunnion type. Refer to page 615.
- * Seal kit includes a grease pack (ø40, ø50: 10 g, ø63, ø80: 20 g, ø100: 30 g). Order with the following part number when only the grease pack is needed.
Grease pack part number: GR-S-010 (10 g), GR-S-020 (20 g)

Air Cylinder: Standard Type Double Acting, Single Rod **CA2 Series**

Basic: C□A2B

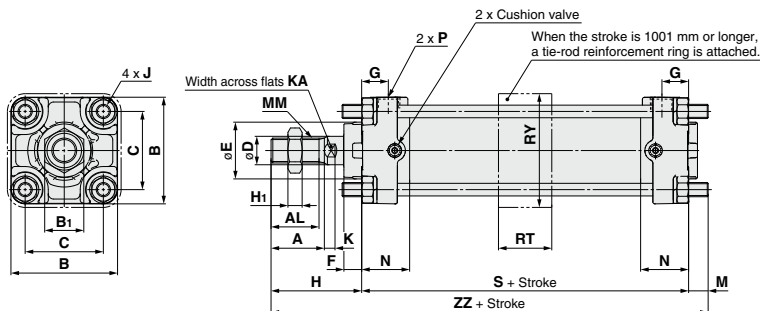

With rod boot

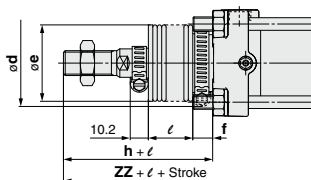

(mm)

Bore size (mm)	A	AL	B	B ₁	C	D	E	F	G	H ₁	J	K	KA	M		MM	
															Without reinforcement ring		With reinforcement ring
40	30	27	60	22	44	16	32	10	15	8	M8 x 1.25	6	14		11	11	M14 x 1.5
50	35	32	70	27	52	20	40	10	17	11	M8 x 1.25	7	18		11	12	M18 x 1.5
63	35	32	85	27	64	20	40	10	17	11	M10 x 1.25	7	18		14	15	M18 x 1.5
80	40	37	102	32	78	25	52	14	21	13	M12 x 1.75	10	22		17	19	M22 x 1.5
100	40	37	116	41	92	30	52	14	21	16	M12 x 1.75	10	26		17	19	M26 x 1.5

Bore size (mm)	N	P	RT	RY	S	Without rod boot				With rod boot					
						H	ZZ		d	e	f	h	l	ZZ	
							Without reinforcement ring	With reinforcement ring						Without reinforcement ring	With reinforcement ring
40	27	1/4	30	64	84	51	146	146	56	43	11.2	59	1/4 stroke	154	154
50	30	3/8	30	76	90	58	159	160	64	52	11.2	66	1/4 stroke	167	168
63	31	3/8	40	92	98	58	170	171	64	52	11.2	66	1/4 stroke	178	179
80	37	1/2	45	112	116	71	204	206	76	65	12.5	80	1/4 stroke	213	215
100	40	1/2	50	136	126	72	215	217	76	65	14	81	1/4 stroke	224	226

Note 1) When a flange bracket is mounted on the head cover side of the basic type with bore size of $\phi 50$ to $\phi 100$ and stroke of 1001 mm or more, it is necessary to loosen the tie-rod to adjust the M dimension. When head flange type is ordered, adjustment is not necessary.

Note 2) For models with bore size of $\phi 50$ to $\phi 100$ and stroke of 1001 mm or more, do not mount a flange bracket on the rod cover side of the basic type since H dimension is different from those shown above. When rod flange type is used, order with the part number with bracket.

CA2 Series

Axial Foot: C□A2L

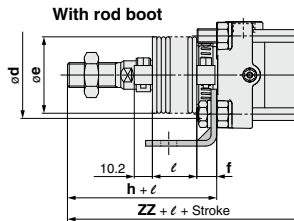
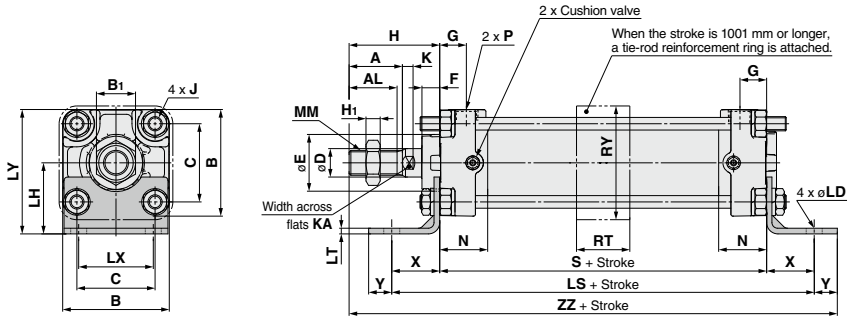

Bore size (mm)	A	AL	B	B ₁	C	D	E	F	G	H ₁	J	K	KA	LD	LH	LS	LT	LX	LY
	40	30	27	60	22	44	16	32	10	15	8	M8 x 1.25	6	14	9	40	138	3.2	42
50	35	32	70	27	52	20	40	10	17	11	M8 x 1.25	7	18	9	45	144	3.2	50	80
63	35	32	85	27	64	20	40	10	17	11	M10 x 1.25	7	18	11.5	50	166	3.2	59	93
80	40	37	102	32	78	25	52	14	21	13	M12 x 1.75	10	22	13.5	65	204	4.5	76	116
100	40	37	116	41	92	30	52	14	21	16	M12 x 1.75	10	26	13.5	75	212	6	92	133

(mm)

Bore size (mm)	MM	N	P	S	X	Y	RT	RY	Without rod boot		With rod boot					
									H	ZZ	d	e	f	h	ℓ	ZZ
40	M14 x 1.5	27	1/4	84	27	13	30	64	51	175	56	43	11.2	59	1/4 stroke	183
50	M18 x 1.5	30	3/8	90	27	13	30	76	58	188	64	52	11.2	66	1/4 stroke	196
63	M18 x 1.5	31	3/8	98	34	16	40	92	58	206	64	52	11.2	66	1/4 stroke	214
80	M22 x 1.5	37	1/2	116	44	16	45	112	71	247	76	65	12.5	80	1/4 stroke	256
100	M26 x 1.5	40	1/2	126	43	17	50	136	72	258	76	65	14.0	81	1/4 stroke	267

Rod Flange: C□A2F

Stroke of 1000 mm or less

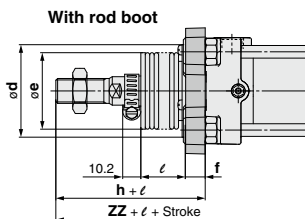
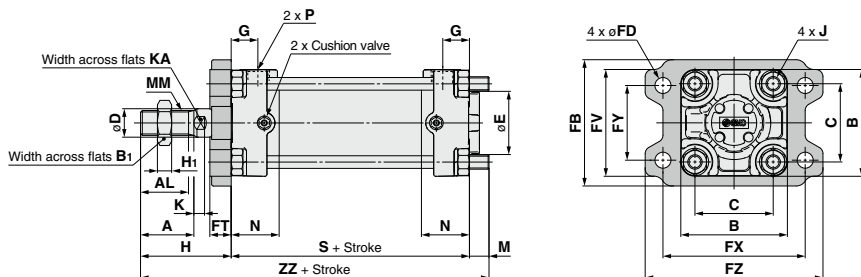

Bore size (mm)	A	AL	B	B ₁	C	D	E	FB	FD	FT	FV	FX	FY	FZ	G	H ₁	J	K	KA
	40	30	27	60	22	44	16	32	71	9	12	60	80	42	100	15	8	M8 x 1.25	6
50	35	32	70	27	52	20	40	81	9	12	70	90	50	110	17	11	M8 x 1.25	7	18
63	35	32	85	27	64	20	40	101	11.5	15	86	105	59	130	17	11	M10 x 1.25	7	18
80	40	37	102	32	78	25	52	119	13.5	18	102	130	76	160	21	13	M12 x 1.75	10	22
100	40	37	116	41	92	30	52	133	13.5	18	116	150	92	180	21	16	M12 x 1.75	10	26

(mm)

Bore size (mm)	M	MM	N	P	S	Without rod boot		With rod boot					
						H	ZZ	*d	e	f	h	ℓ	ZZ
40	11	M14 x 1.5	27	1/4	84	51	146	52	43	15	59	1/4 stroke	154
50	11	M18 x 1.5	30	3/8	90	58	159	58	52	15	66	1/4 stroke	167
63	14	M18 x 1.5	31	3/8	98	58	170	58	52	17.5	66	1/4 stroke	178
80	17	M22 x 1.5	37	1/2	116	71	204	80	65	21.5	80	1/4 stroke	213
100	17	M26 x 1.5	40	1/2	126	72	215	80	65	21.5	81	1/4 stroke	224

★For installing an air cylinder, when a hole must be made to accommodate the rod portion, make sure to machine a hole that is larger than the outer diameter of the boot mounting bracket ϕd .

CA2 Series

Rod Flange: C□A2F

Stroke of 1001 mm or more

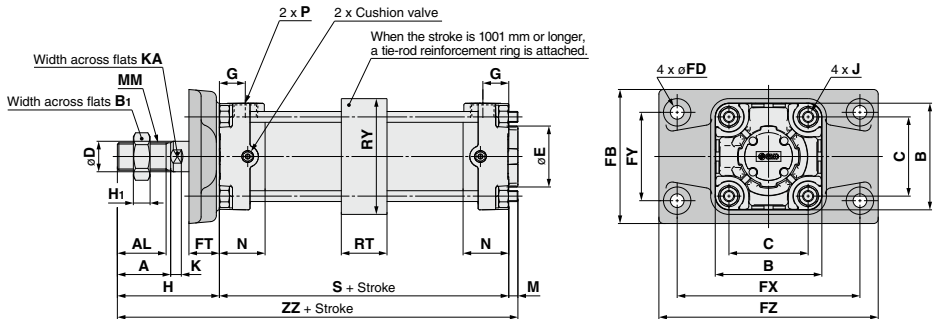

With rod boot

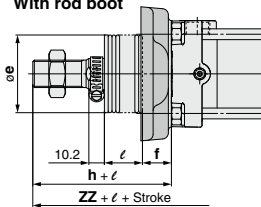

Bore size (mm)																	(mm)			
	A	AL	B	B ₁	C	D	E	FB	FD	FT	FX	FY	FZ	G	H ₁	J	K	KA	M	
40	30	27	60	22	44	16	32	71	9	12	80	42	100	15	8	M8 x 1.25	6	14	11	
50	35	32	70	27	52	20	40	88	9	20	120	58	144	17	11	M8 x 1.25	7	18	6	
63	35	32	85	27	64	20	40	105	11.5	23	140	64	170	17	11	M10 x 1.25	7	18	10	
80	40	37	102	32	78	25	52	124	13.5	28	164	84	198	21	13	M12 x 1.75	10	22	12	
100	40	37	116	41	92	30	52	140	13.5	29	180	100	220	21	16	M12 x 1.75	10	26	12	

Bore size (mm)	MM	N	P	RT	RY	S	Without rod boot				With rod boot			
							H	ZZ	*e	f	h	l	ZZ	
40	M14 x 1.5	27	1/4	30	64	84	51	146	52	19	66	1/4 stroke	162	
50	M18 x 1.5	30	3/8	30	76	90	67	163	52	19	66	1/4 stroke	162	
63	M18 x 1.5	31	3/8	40	92	98	71	179	52	19	66	1/4 stroke	174	
80	M22 x 1.5	37	1/2	45	112	116	87	215	65	21	80	1/4 stroke	208	
100	M26 x 1.5	40	1/2	50	136	126	89	227	65	21	81	1/4 stroke	219	

★For installing an air cylinder, when a hole must be made to accommodate the rod portion, make sure to machine a hole that is larger than the outer diameter of the boot øe.

Note 1) For flange type with bore size of ø40, the same flange bracket is used for all strokes.

Note 2) For models with bore size of ø50 to ø100 and stroke of 1001 mm or more, do not mount a flange bracket on the rod cover side of the basic type since H dimension is different from those shown above. When rod flange type is used, order with the part number with bracket.

Head Flange: □A2G

Stroke of 1000 mm or less

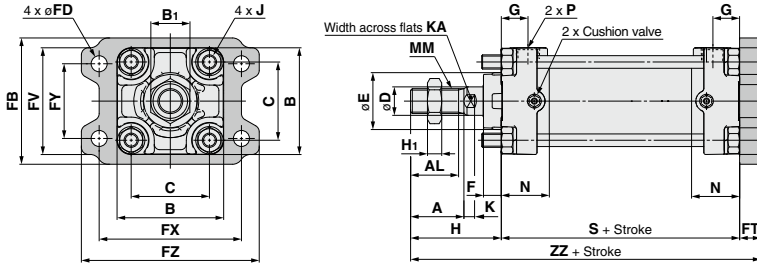

With rod boot

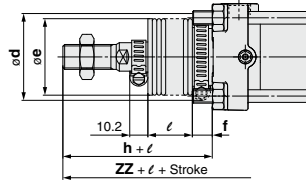

(mm)

Bore size (mm)	A	AL	B	B ₁	C	D	E	F	FB	FD	FT	FV	FX	FY	FZ	G	H ₁	J
40	30	27	60	22	44	16	32	10	71	9	12	60	80	42	100	15	8	M8 x 1.25
50	35	32	70	27	52	20	40	10	81	9	12	70	90	50	110	17	11	M8 x 1.25
63	35	32	85	27	64	20	40	10	101	11.5	15	86	105	59	130	17	11	M10 x 1.25
80	40	37	102	32	78	25	52	14	119	13.5	18	102	130	76	160	21	13	M12 x 1.75
100	40	37	116	41	92	30	52	14	133	13.5	18	116	150	92	180	21	16	M12 x 1.75

Bore size (mm)	K	KA	MM	N	P	S	Without rod boot		With rod boot					
							H	ZZ	d	e	f	h	ℓ	ZZ
40	6	14	M14 x 1.5	27	1/4	84	51	147	56	43	11.2	59	1/4 stroke	155
50	7	18	M18 x 1.5	30	3/8	90	58	160	64	52	11.2	66	1/4 stroke	168
63	7	18	M18 x 1.5	31	3/8	98	58	171	64	52	11.2	66	1/4 stroke	179
80	10	22	M22 x 1.5	37	1/2	116	71	205	76	65	12.5	80	1/4 stroke	214
100	10	26	M26 x 1.5	40	1/2	126	72	216	76	65	14.0	81	1/4 stroke	225

CA2 Series

Head Flange: □A2G

Stroke of 1001 mm or more

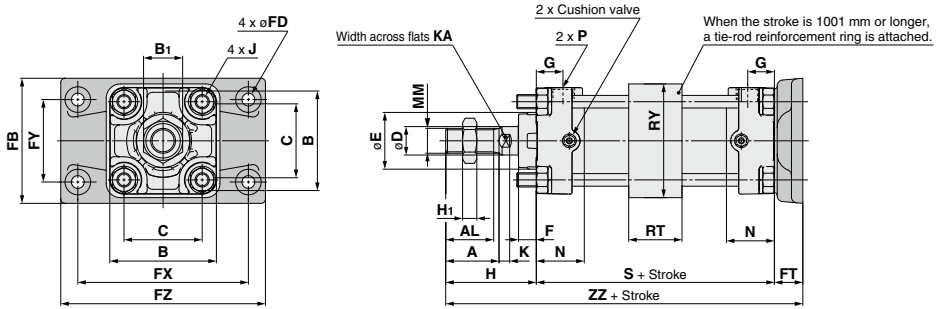

With rod boot

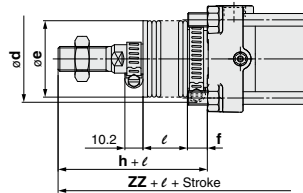

Bore size (mm)	A	AL	B	B ₁	C	D	E	FB	FD	FT	FX	FY	FZ	G	H ₁	J	K	KA
	40	30	27	60	22	44	16	30	71	9	12	80	42	100	15	8	M8 x 1.25	6
50	35	32	70	27	52	20	40	88	9	20	120	58	144	17	11	M8 x 1.25	7	18
63	35	32	85	27	64	20	40	105	11.5	23	140	64	170	17	11	M10 x 1.25	7	18
80	40	37	102	32	78	25	52	124	13.5	28	164	84	198	21	13	M12 x 1.75	10	22
100	40	37	116	41	92	30	52	140	13.5	29	180	100	220	21	16	M12 x 1.75	10	26

Bore size (mm)	MM	N	P	S	RT	RY	Without rod boot		With rod boot					
							H	ZZ	d	e	f	h	ℓ	ZZ
40	M14 x 1.5	27	1/4	84	30	64	51	147	56	43	11.2	59	1/4 stroke	155
50	M18 x 1.5	30	3/8	90	30	76	58	168	64	52	11.2	66	1/4 stroke	176
63	M18 x 1.5	31	3/8	98	40	92	58	179	64	52	11.2	66	1/4 stroke	187
80	M22 x 1.5	37	1/2	116	45	112	71	215	76	65	12.5	80	1/4 stroke	224
100	M26 x 1.5	40	1/2	126	50	136	72	227	76	65	14	81	1/4 stroke	236

Note 1) For flange type with bore size of ø40, the same flange bracket is used for all strokes.

Note 2) When a flange bracket is mounted on the head cover side of the basic type with bore size of ø50 to ø100 and stroke of 1001 mm or more, it is necessary to loosen the tie-rod to adjust the M dimension. When head flange type is ordered, adjustment is not necessary.

Single Clevis: C□A2C

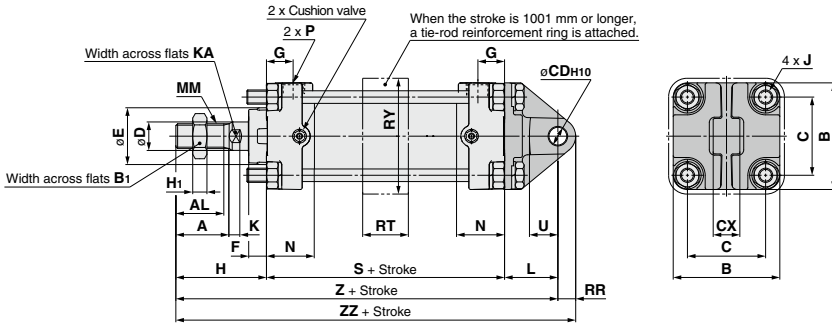

With rod boot

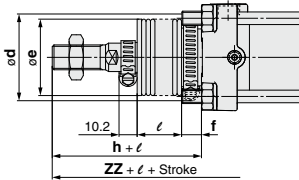

(mm)

Bore size (mm)	A	AL	B	B ₁	C	CD _{H10}	CX	D	E	F	G	H ₁	J	K	KA	L
40	30	27	60	22	44	10 ^{+0.058} ₀	15 ^{-0.1} _{-0.3}	16	32	10	15	8	M8 x 1.25	6	14	30
50	35	32	70	27	52	12 ^{+0.070} ₀	18 ^{-0.1} _{-0.3}	20	40	10	17	11	M8 x 1.25	7	18	35
63	35	32	85	27	64	16 ^{+0.070} ₀	25 ^{-0.1} _{-0.3}	20	40	10	17	11	M10 x 1.25	7	18	40
80	40	37	102	32	78	20 ^{+0.084} ₀	31.5 ^{-0.1} _{-0.3}	25	52	14	21	13	M12 x 1.75	10	22	48
100	40	37	116	41	92	25 ^{+0.084} ₀	35.5 ^{-0.1} _{-0.3}	30	52	14	21	16	M12 x 1.75	10	26	58

Bore size (mm)	MM	N	P	RR	S	U	Without rod boot			With rod boot						
							H	Z	ZZ	d	e	f	h	ℓ	Z	ZZ
40	M14 x 1.5	27	1/4	10	84	16	51	165	175	56	43	11.2	59	1/4 stroke	173	183
50	M18 x 1.5	30	3/8	12	90	19	58	183	195	64	52	11.2	66	1/4 stroke	191	203
63	M18 x 1.5	31	3/8	16	98	23	58	196	212	64	52	11.2	66	1/4 stroke	204	220
80	M22 x 1.5	37	1/2	20	116	28	71	235	255	76	65	12.5	80	1/4 stroke	244	264
100	M26 x 1.5	40	1/2	25	126	36	72	256	281	76	65	14.0	81	1/4 stroke	265	290

CA2 Series

Double Clevis: C□A2D

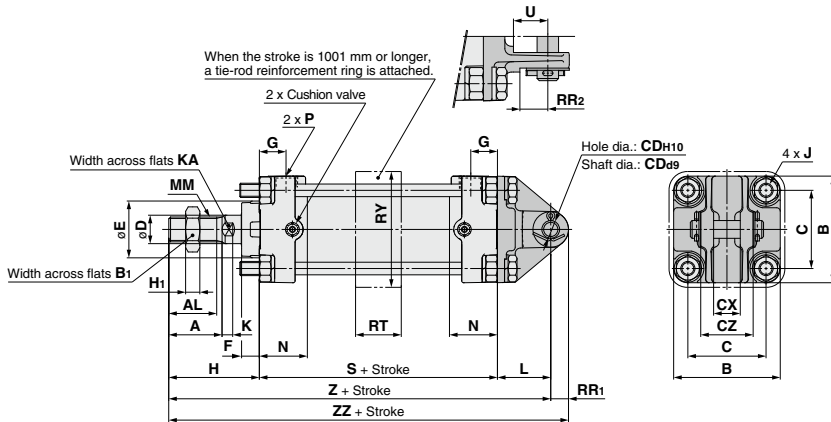

With rod boot

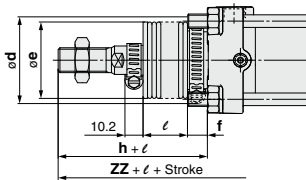

Bore size (mm)															(mm)		
	A	AL	B	B ₁	C	CD _{H10}	CX	CZ	D	E	F	G	H ₁	J	K	KA	L
40	30	27	60	22	44	10 ^{+0.058} ₀	15 ^{+0.3} _{-0.1}	29.5	16	32	10	15	8	M8 x 1.25	6	14	30
50	35	32	70	27	52	12 ^{+0.070} ₀	18 ^{+0.3} _{-0.1}	38	20	40	10	17	11	M8 x 1.25	7	18	35
63	35	32	85	27	64	16 ^{+0.070} ₀	25 ^{+0.3} _{-0.1}	49	20	40	10	17	11	M10 x 1.25	7	18	40
80	40	37	102	32	78	20 ^{+0.084} ₀	31.5 ^{+0.3} _{-0.1}	61	25	52	14	21	13	M12 x 1.75	10	22	48
100	40	37	116	41	92	25 ^{+0.084} ₀	35.5 ^{+0.3} _{-0.1}	64	30	52	14	21	16	M12 x 1.75	10	26	58

Bore size (mm)	MM	N	P	RR ₁	RR ₂	S	U	Without rod boot			With rod boot						
								H	Z	ZZ	d	e	f	h	ℓ	Z	ZZ
40	M14 x 1.5	27	1/4	10	16	84	16	51	165	175	56	43	11.2	59	1/4 stroke	173	183
50	M18 x 1.5	30	3/8	12	19	90	19	58	183	195	64	52	11.2	66	1/4 stroke	191	203
63	M18 x 1.5	31	3/8	16	23	98	23	58	196	212	64	52	11.2	66	1/4 stroke	204	220
80	M22 x 1.5	37	1/2	20	28	116	28	71	235	255	76	65	12.5	80	1/4 stroke	244	264
100	M26 x 1.5	40	1/2	25	23.5	126	36	72	256	281	76	65	14.0	81	1/4 stroke	265	290

* A clevis pin, flat washers and split pins are included.

Center Trunnion: **C□A2T**

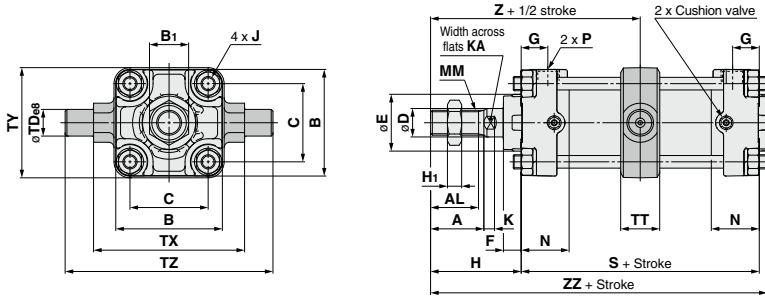

With rod boot

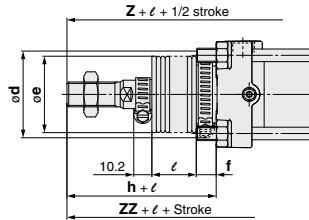

Bore size (mm)	A	AL	B	B ₁	C	D	E	F	G	H ₁	J	K	KA	MM	N	P	S	(mm)	
																		Z	ZZ
40	30	27	60	22	44	16	32	10	15	8	M8 x 1.25	6	14	M14 x 1.5	27	1/4	84	Z	ZZ
50	35	32	70	27	52	20	40	10	17	11	M8 x 1.25	7	18	M18 x 1.5	30	3/8	90	Z	ZZ
63	35	32	85	27	64	20	40	10	17	11	M10 x 1.25	7	18	M18 x 1.5	31	3/8	98	Z	ZZ
80	40	37	102	32	78	25	52	14	21	13	M12 x 1.75	10	22	M22 x 1.5	37	1/2	116	Z	ZZ
100	40	37	116	41	92	30	52	14	21	16	M12 x 1.75	10	26	M26 x 1.5	40	1/2	126	Z	ZZ

Bore size (mm)	TD _{ø8}	TT	TX	TY	TZ	Without rod boot			With rod boot						
						H	Z	ZZ	d	e	f	h	ℓ	Z	ZZ
40	15 ^{+0.032} _{-0.059}	22	85	62	117	51	93	140	56	43	11.2	59	1/4 stroke	101	148
50	15 ^{+0.032} _{-0.059}	22	95	74	127	58	103	154	64	52	11.2	66	1/4 stroke	111	162
63	16 ^{+0.048} _{-0.059}	28	110	90	148	58	107	162	64	52	11.2	66	1/4 stroke	115	170
80	25 ^{+0.048} _{-0.073}	34	140	110	192	71	129	194	76	65	12.5	80	1/4 stroke	138	203
100	25 ^{+0.048} _{-0.073}	40	162	130	214	72	135	206	76	65	14.0	81	1/4 stroke	144	215

* Do not disassemble the trunnion type. Refer to page 615.

CA2 Series

Trunnion and Double Clevis Pivot Bracket

- Strength is the same as cylinder brackets.

Applicable Series

Bracket type	Applicable series
Trunnion pivot bracket	CA2
Double clevis pivot bracket	CA2

* Please contact SMC at the time of mounting.

Bore size	CA2□40	CA2□50	CA2□63	CA2□80	CA2□100
Description	CA2-S04	CA2-S06	CA2-S06	CA2-B08	CA2-B10
Trunnion pivot bracket	CA2-S04		CA2-S06	MB-S10	
Double clevis pivot bracket	CA2-B04	CA2-B05	CA2-B06	CA2-B08	CA2-B10

* Order 2 trunnion pivot brackets per cylinder.

Trunnion pivot bracket

Material: Cast iron

Surface treatment: Metallic silver

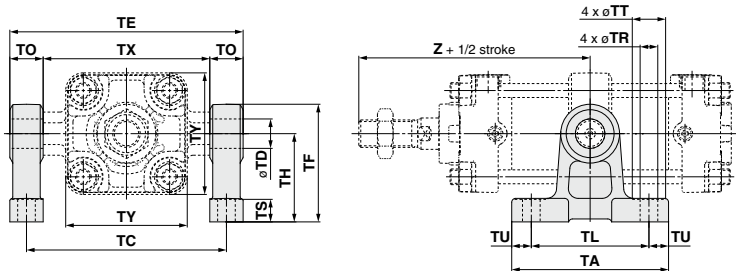

(mm)

Part no.	Bore size (mm)	TA	TL	TU	TC	TX	TE	TO	TR	TT	TS	TH	TF	TY	Z	TD-H10 (Hole)
CA2-S04	40	80	60	10	102	85	119	17	9	17	12	45	60	62	93	15 ^{+0.070/0}
	50	80	60	10	112	95	129	17	9	17	12	45	60	74	103	15 ^{+0.070/0}
CA2-S06	63	100	70	15	130	110	150	20	11	22	14	55	73	90	107	18 ^{+0.070/0}
	80	120	90	15	166	140	192	26	13.5	24	17	75	100	110	129	25 ^{+0.084/0}
MB-S10	100	120	90	15	188	162	214	26	13.5	24	17	75	100	130	135	25 ^{+0.084/0}

Double clevis pivot bracket

Material: Cast iron

Surface treatment: Metallic silver

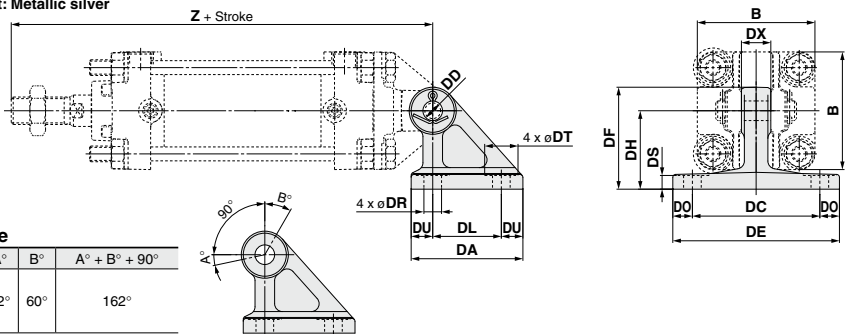

Rotating Angle

Bore size (mm)	A°	B°	A° + B° + 90°
40 to 100	12°	60°	162°

(mm)

Part no.	Bore size (mm)	DA	DL	DU	DC	DX	DE	DO	DR	DT	DS	DH	DF	B	Z	DDH10 (Hole)
CA2-B04	40	57	35	11	65	15	85	10	9	17	8	40	52	60	165	10 ^{+0.058/0}
CA2-B05	50	57	35	11	65	18	85	10	9	17	8	40	52	70	183	12 ^{+0.070/0}
CA2-B06	63	67	40	13.5	80	25	105	12.5	11	22	10	50	66	85	196	16 ^{+0.070/0}
CA2-B08	80	93	60	16.5	100	31.5	130	15	13.5	24	12	65	90	102	235	20 ^{+0.084/0}
CA2-B10	100	93	60	16.5	100	35.5	130	15	13.5	24	12	65	90	116	256	25 ^{+0.084/0}

CA2 Series

Dimensions of Accessories

Double Knuckle Joint

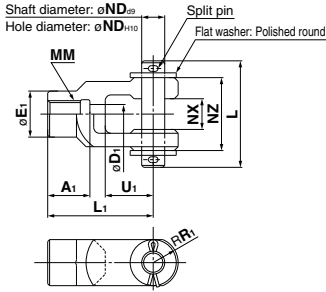

Material: Cast iron Surface treatment: Metallic silver (mm)

Part no.	Applicable bore size	A ₁	E ₁	D ₁	L ₁	MM	R ₁	U ₁	ND	NX	NZ	L	Split pin size	Flat washer size
Y-04D	40	22	24	10	55	M14 x 1.5	13	25	12	16 ^{+0.3} _{+0.1}	38	55.5	ø3 x 18 L	Polished round 12
Y-05D	50, 63	27	28	14	60	M18 x 1.5	15	27	12	16 ^{+0.3} _{+0.1}	38	55.5	ø3 x 18 L	Polished round 12
Y-08D	80	37	36	18	71	M22 x 1.5	19	28	18	26 ^{+0.3} _{+0.1}	55	76.5	ø4 x 25 L	Polished round 18
Y-10D	100	37	40	21	83	M26 x 1.5	21	38	20	30 ^{+0.3} _{+0.1}	61	83	ø4 x 30 L	Polished round 20

* A knuckle pin, split pins and flat washers are included.

Clevis Pin/Knuckle Pin

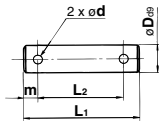

Material: Carbon steel Surface treatment (Split pin/Flat washer): Trivalent zinc chromated (mm)

Part no.	Applicable bore size		Dd9	L ₁	L ₂	m	d	Included split pin	Included flat washer
	Clevis	Knuckle							
CDP-2A	40	—	10 ^{-0.040} _{-0.076}	46	38	4	3	ø3 x 18 L	Polished round 10
CDP-3A	50	40, 50, 63	12 ^{-0.050} _{-0.093}	55.5	47.5	4	3	ø3 x 18 L	Polished round 12
CDP-4A	63	—	16 ^{-0.050} _{-0.093}	71	61	5	4	ø4 x 25 L	Polished round 16
CDP-5A	—	80	18 ^{-0.050} _{-0.093}	76.5	66.5	5	4	ø4 x 25 L	Polished round 18
CDP-6A	80	100	20 ^{-0.065} _{-0.117}	83	73	5	4	ø4 x 30 L	Polished round 20
CDP-7A	100	—	25 ^{-0.065} _{-0.117}	88	78	5	4	ø4 x 36 L	Polished round 24

* Split pins and flat washers are included.

Single Knuckle Joint

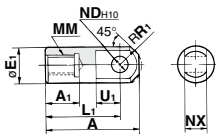

Material: Free cutting sulfur steel Surface treatment: Electroless nickel plating (mm)

Part no.	Applicable bore size	A	A ₁	E ₁	L ₁	MM	R ₁	U ₁	ND _{H10}	NX
I-04A	40	69	22	24	55	M14 x 1.5	15.5	20	12 ^{+0.070} ₀	16 ^{-0.1} _{-0.3}
I-05A	50, 63	74	27	28	60	M18 x 1.5	15.5	20	12 ^{+0.070} ₀	16 ^{-0.1} _{-0.3}
I-08A	80	91	37	36	71	M22 x 1.5	22.5	26	18 ^{+0.070} ₀	28 ^{-0.1} _{-0.3}
I-10A	100	105	37	40	83	M26 x 1.5	24.5	28	20 ^{+0.084} ₀	30 ^{-0.1} _{-0.3}

Rod End Nut (Standard)

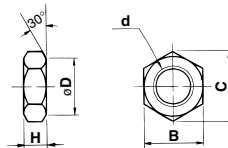

Material: Rolled steel Surface treatment: Trivalent zinc chromated (mm)

Part no.	Applicable bore size	d	H	B	C	D
NT-04	40	M14 x 1.5	8	22	25.4	21
NT-05	50, 63	M18 x 1.5	11	27	31.2	26
NT-08	80	M22 x 1.5	13	32	37.0	31
NT-10	100	M26 x 1.5	16	41	47.3	39

Air Cylinder: Standard Type

Double Acting, Double Rod

CA2W Series

ø40, ø50, ø63, ø80, ø100



How to Order

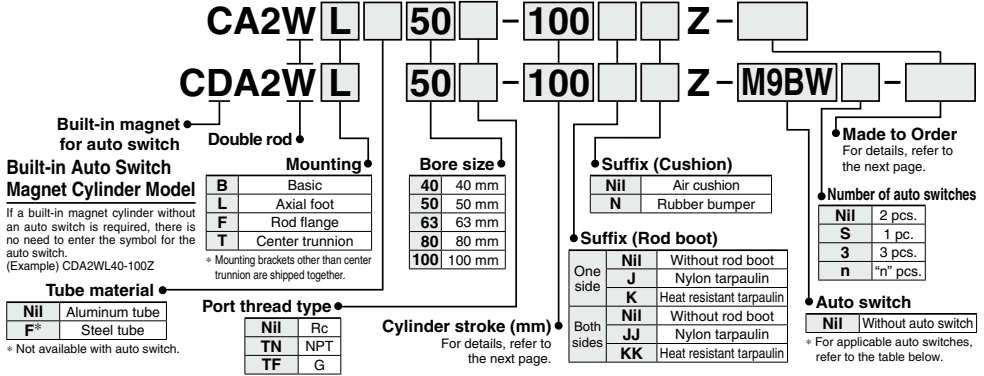

Applicable Auto Switches/Refer to pages 1271 to 1365 for further information on auto switches.

Type	Special function	Electrical entry	Indication light	Wiring (Output)	Load voltage		Auto switch model		Lead wire length (m)					Pre-wired connector	Applicable load					
					DC	AC	Tie-rod mounting	Band mounting	0.5 (Nil)	1 (M)	3 (L)	5 (Z)	IC circuit		Relay, PLC					
Solid state auto switch	—	Grommet	No	3-wire (NPN)	24 V	5 V, 12 V	—	M9N	●	●	○	○	○	IC circuit	—	—				
				3-wire (PNP)				G59	●	●	○	○								
				2-wire	M9P	●	●	○	○											
		Terminal conduit		3-wire (NPN)	12 V	—	G39C	G39	—	—	—	—	—				—	IC circuit	—	—
				2-wire			K39C	K39	—	—	—	—								
				3-wire (NPN)	5 V, 12 V	—	M9NW	●	●	○	○									
	3-wire (PNP)	G59W	●	●			○	○												
	Diagnostic indication (2-color indicator)	Grommet	Yes	2-wire	24 V	12 V	—	M9PW	●	●	○	○	IC circuit	Relay, PLC						
				3-wire (PNP)				G5PW	●	●	○	○								
				2-wire	M9BW	●	●	○	○											
		Grommet		3-wire (NPN)	5 V, 12 V	—	M9NA*1	—	○	○	●	○			—	—				
				3-wire (PNP)			M9PA*1	—	○	○	●	○								
2-wire				M9BA*1	—	○	○	●	○											
With diagnostic output (2-color indicator)	Grommet	No	4-wire (NPN)	24 V	12 V	—	G5BA*1	—	—	—	—	IC circuit	—	—						
			2-wire (Non-polar)				F59F	G59F	●	—	●				○	○				
			2-wire (Non-polar)	P3DWA	P4DW	—	—	—	—	—	—									
Reed auto switch	—	Grommet	Yes	3-wire (NPN equiv.)	24 V	12 V	—	A96	—	●	●	—	—	IC circuit	—					
				100 V				A93	—	—	●	●	—			—				
				100 V or less	A90	—	—	●	●	—	—	IC circuit	Relay, PLC							
				100 V, 200 V	A54	B54	—	—	●	●	—			—						
				200 V or less	A64	B64	—	—	●	●	—	—								
		Terminal conduit		No	—	2-wire	24 V	12 V	—	A33C	A33	—	—	—	—	—	PLC			
										A34C	A34	—	—	—	—					
										A44C	A44	—	—	—	—					
										A59W	B59W	●	—	●	—					
										100 V, 200 V	A44C	A44	—	—	—			—		

*1 Water resistant type auto switches can be mounted on the above models, but in such case SMC cannot guarantee water resistance.

A water-resistant type cylinder is recommended for use in an environment which requires water resistance.

* Lead wire length symbols: 0.5 m.....Nil (Example) M9NW 3 m.....L (Example) M9NWL 1 m.....M (Example) M9NWM 5 m.....Z (Example) M9NWZ

* Solid state auto switches marked with "○" are produced upon receipt of order.

* Since there are other applicable auto switches than listed above, refer to page 613 for details.

* For details about auto switches with pre-wired connector, refer to pages 1340 and 1341.

* The D-A9□/M9□□□P3DWA□ auto switches are shipped together, (but not assembled). (However, auto switch mounting brackets are assembled for the D-A9□/M9□□ before shipment.)

Specifications

Bore size (mm)	40	50	63	80	100
Fluid	Air				
Action	Double acting				
Proof pressure	1.5 MPa				
Maximum operating pressure	1.0 MPa				
Minimum operating pressure	0.08 MPa				
Piston speed	50 to 500 mm/s				
Ambient and fluid temperature	Without auto switch magnet : -10 to 70°C* Built-in magnet for auto switch: -10 to 60°C*				
Cushion	Air cushion or Rubber bumper				
Stroke length tolerance	Up to 250 st: $^{+1.0}_0$ 251 to 1000 st: $^{+1.4}_0$ 1001 to 1500 st: 0 to +1.8 1501 to 1800 st: 0 to +2.2				
Lubrication	Not required (Non-lube)				
Mounting	Basic, Axial foot, Rod flange, Center trunnion				

* No freezing



Symbol

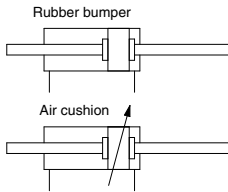

Made to Order

[Click here for details](#)

Symbol	Specifications
-XA	Change of rod end shape
-XB6	Heat resistant cylinder (-10 to 150°C)
-XC3	Special port location*
-XC4	With heavy duty scraper
-XC5	Heat resistant cylinder (-10 to 110°C)
-XC7	Tie-rod, cushion valve, tie-rod nut, etc. made of stainless steel
-XC14	Change of trunnion bracket mounting position
-XC15	Change of tie-rod length
-XC22	Fluororubber seal
-XC28	Compact flange made of SS400
-XC35	With coil scraper
-XC58	Water resistant/ Built-in hard plastic magnet*
-XC59	Fluororubber seal/ Built-in hard plastic magnet*
-XC65	Made of stainless steel (Combination of XC7 and XC68)
-XC68	Made of stainless steel (with hard chrome plated piston rod)
-XC85	Grease for food processing equipment

For special port location (-XC3), the mounting bracket and port location can be determined using the standard product corresponding to the operating conditions.

* The cover shape and model are the same as those of the existing CA2 series product.

Refer to pages 607 to 613 for cylinders with auto switches.

- Auto switch proper mounting position (detection at stroke end) and its mounting height
- Operating range
- Minimum stroke for auto switch mounting
- Auto switch mounting brackets/Part no.

Standard Strokes

Bore size	Standard stroke	Stroke range Note 3)	
		Air cushion	Rubber bumper
40	25, 50, 75, 100, 125, 150, 175, 200, 250, 300, 350, 400, 450, 500	1 to 1800	1 to 700
50, 63	25, 50, 75, 100, 125, 150, 175, 200, 250, 300, 350, 400, 450, 500, 600		
80, 100	25, 50, 75, 100, 125, 150, 175, 200, 250, 300, 350, 400, 450, 500, 600, 700		1 to 650

Note 1) Aside from the standard strokes, intermediate strokes (within stroke range) are also available in 1 mm increments and are produced upon receipt of order.
Note 2) Applicable strokes should be confirmed according to the usage. For details, refer to "Air Cylinders Model Selection" on front matter pages. In addition, the products that exceed the standard stroke might not be able to fulfill the specifications due to the deflection etc. Strokes which exceed the standard stroke length will be available as special order.

Note 3) The stroke range for the type with a rod boot is shown in the table below. Strokes exceeding those in the table below are only available as a special order.

Bore size	Stroke range (mm)	
	Air cushion	Rubber bumper
40 to 63		20 to 550
80, 100	20 to 1400	20 to 500

Minimum Stroke for Auto Switch Mounting

Caution

The minimum stroke for mounting varies with the auto switch type and cylinder mounting type. In particular, the center trunnion type needs careful attention. (For details, refer to pages 611 and 612.)

Rod Boot Material

Symbol	Rod boot material	Max. ambient temperature
J	Nylon tarpaulin	70°C
K	Heat resistant tarpaulin	110°C*

* Maximum ambient temperature for the rod boot

* The rod boot replacement part numbers are listed in the "Maintenance Parts List." [Click here](#) for further details.

Accessories

Mounting		Basic	Foot	Flange	Center trunnion
Standard	Rod end nut	●	●	●	●
Option	Single knuckle joint	●	●	●	●
	Double knuckle joint (with pin)	●	●	●	●
	With rod boot	●	●	●	●

* Refer to page 575 for part numbers and dimensions.

Weights/Aluminum Tube (Steel Tube)

Bore size (mm)		(kg)						
		40	50	63	80	100		
Basic weight	Basic	Aluminum tube	0.92	1.38	1.86	3.32	4.55	
		Steel tube	0.97	1.44	1.96	3.5	4.83	
	Axial foot	Aluminum tube	1.11	1.6	2.19	3.99	5.54	
		Steel tube	1.16	1.66	2.29	4.17	5.82	
	Flange	Aluminum tube	1.29	1.83	2.65	4.77	6.47	
		Steel tube	1.34	1.89	2.75	4.95	6.75	
Trunnion	Aluminum tube	1.28	1.86	2.66	4.87	6.83		
	Steel tube	1.33	1.92	2.76	5.05	7.11		
Additional weight per 50 mm of stroke	All mounting brackets	Aluminum tube	0.28	0.37	0.44	0.66	0.86	
	Steel tube	0.35	0.47	0.55	0.89	1.15		
Accessories	Single knuckle	0.23	0.26	0.26	0.60	0.83		
	Double knuckle (with pin)	0.37	0.43	0.43	0.87	1.27		

Calculation:
(Example) **CA2WL40-100**
(Axial foot, ø40, 100 stroke)
• Basic weight
..... 1.18 (Axial foot, ø40)
• Additional weight
..... 0.28/50 stroke
• Cylinder stroke
..... 100 stroke

1.18 + 0.28 x 100/50 = **1.74 kg**

CA2W Series

Mounting Bracket Part No.

Bore size (mm)	40	50	63	80	100
Axial foot*	CA2-L04	CA2-L05	CA2-L06	CA2-L08	CA2-L10
Flange	CA2-F04	CA2-F05	CA2-F06	CA2-F08	CA2-F10

* When axial foot brackets are used, order two pieces per cylinder.

Construction

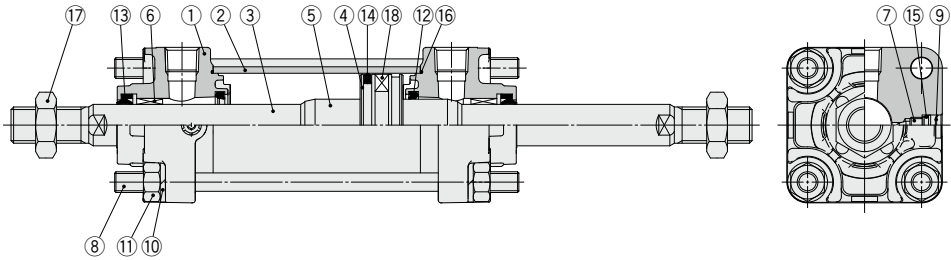

Component Parts

No.	Description	Material	Q'ty	Note
1	Rod cover	Aluminum die-casted	2	Trivalent chromated
2	Cylinder tube	Aluminum alloy	1	Hard anodized
3	Piston rod	Carbon steel	1	Hard chrome plating
4	Piston	Aluminum alloy	1	
5	Cushion ring	Aluminum alloy	2	Anodized
6	Bushing	Bearing alloy	1	
7	Cushion valve	Steel wire	2	Trivalent zinc chromated
8	Tie-rod	Carbon steel	4	Trivalent zinc chromated
9	Retaining ring	Spring steel	2	Phosphate coating
10	Spring washer	Steel wire	8	Trivalent zinc chromated
11	Tie-rod nut	Rolled steel	8	Trivalent zinc chromated
12	Cushion seal	Urethane	2	
13	Rod seal	NBR	2	
14	Piston seal	NBR	1	
15	Cushion valve seal	NBR	2	
16	Cylinder tube gasket	NBR	2	
17	Rod end nut	Rolled steel	2	Trivalent zinc chromated
18	Magnet	—	(1)	

Replacement Parts: Seal Kit

Bore size (mm)	Kit no.	Contents
	Pneumatic type	
40	CA2W40Z-PS	Set of the nos. 12, 13, 14, 16
50	CA2W50Z-PS	
63	CA2W63Z-PS	
80	CA2W80Z-PS	
100	CA2W100Z-PS	

* Do not disassemble the trunnion type. Refer to page 615.

* Seal kit includes 12, 13, 14, 16. Order the seal kit based on each bore size.

* Seal kit includes a grease pack (ø40, ø50: 10 g, ø63, ø80: 20 g, ø100: 30 g).

Order with the following part number when only the grease pack is needed.

Grease pack part number: GR-S-010 (10 g), GR-S-020 (20 g)

Air Cylinder: Standard Type **CA2W Series**

Basic: C□A2WB

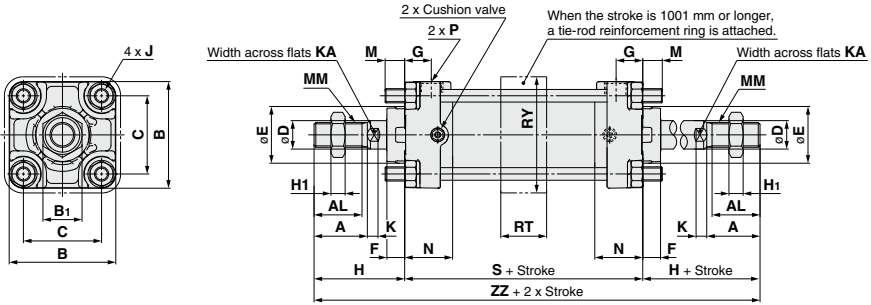

With rod boot (One side)

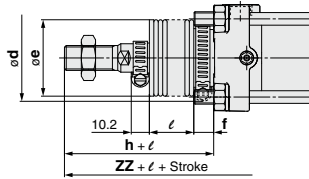

With rod boot (Both sides)

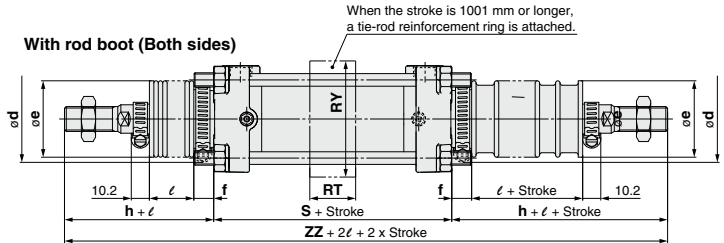

(mm)

Bore size (mm)	A	AL	B	B ₁	C	D	E	F	G	H ₁	J	K	KA	M	MM
40	30	27	60	22	44	16	32	10	15	8	M8 x 1.25	6	14	11	M14 x 1.5
50	35	32	70	27	52	20	40	10	17	11	M8 x 1.25	7	18	11	M18 x 1.5
63	35	32	85	27	64	20	40	10	17	11	M10 x 1.25	7	18	14	M18 x 1.5
80	40	37	102	32	78	25	52	14	21	13	M12 x 1.75	10	22	17	M22 x 1.5
100	40	37	116	41	92	30	52	14	21	16	M12 x 1.75	10	26	17	M26 x 1.5

Bore size (mm)	N	P	RT	RY	S	Without rod boot		With rod boot (One side)							[Both sides]	
						H	ZZ	d	e	f	h	ℓ	ZZ	ZZ		
40	27	1/4	30	64	84	51	186	56	43	11.2	59	1/4 stroke	194	202		
50	30	3/8	30	76	90	58	206	64	52	11.2	66	1/4 stroke	214	222		
63	31	3/8	40	92	98	58	214	64	52	11.2	66	1/4 stroke	222	230		
80	37	1/2	45	112	116	71	258	76	65	12.5	80	1/4 stroke	267	276		
100	40	1/2	50	136	126	72	270	76	65	14.0	81	1/4 stroke	279	288		

CA2W Series

Axial Foot: C□A2WL

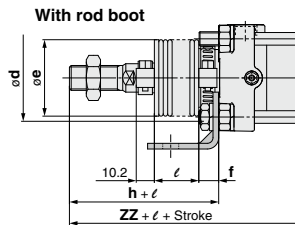
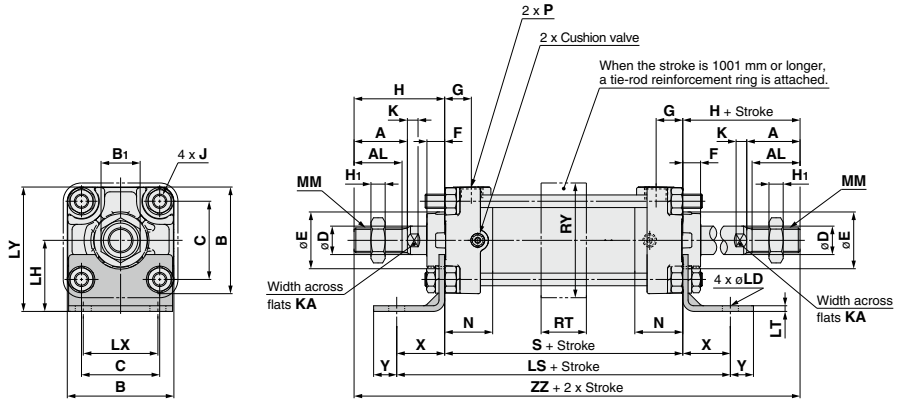

(mm)

Bore size (mm)	A	AL	B	B ₁	C	D	E	F	G	H ₁	J	K	KA	LD	LH	LS	LT	LX	LY
40	30	27	60	22	44	16	32	10	15	8	M8 x 1.25	6	14	9	40	138	3.2	42	70
50	35	32	70	27	52	20	40	10	17	11	M8 x 1.25	7	18	9	45	144	3.2	50	80
63	35	32	85	27	64	20	40	10	17	11	M10 x 1.25	7	18	11.5	50	166	3.2	59	93
80	40	37	102	32	78	25	52	14	21	13	M12 x 1.75	10	22	13.5	65	204	4.5	76	116
100	40	37	116	41	92	30	52	14	21	16	M12 x 1.75	10	26	13.5	75	212	6	92	133

Bore size (mm)	MM	N	P	RT	RY	S	X	Y	Without rod boot		With rod boot (One side)						[Both sides]	
									H	ZZ	d	e	f	h	l	ZZ	ZZ	
40	M14 x 1.5	27	1/4	30	64	84	27	13	51	186	56	43	11.2	59	1/4 stroke	194	202	
50	M18 x 1.5	30	3/8	30	76	90	27	13	58	206	64	52	11.2	66	1/4 stroke	214	222	
63	M18 x 1.5	31	3/8	40	92	98	34	16	58	214	64	52	11.2	66	1/4 stroke	222	230	
80	M22 x 1.5	37	1/2	45	112	116	44	16	71	258	76	65	12.5	80	1/4 stroke	267	276	
100	M26 x 1.5	40	1/2	50	136	126	43	17	72	270	76	65	14.0	81	1/4 stroke	279	288	

Rod Flange: C□A2WF

Stroke of 1000 mm or less

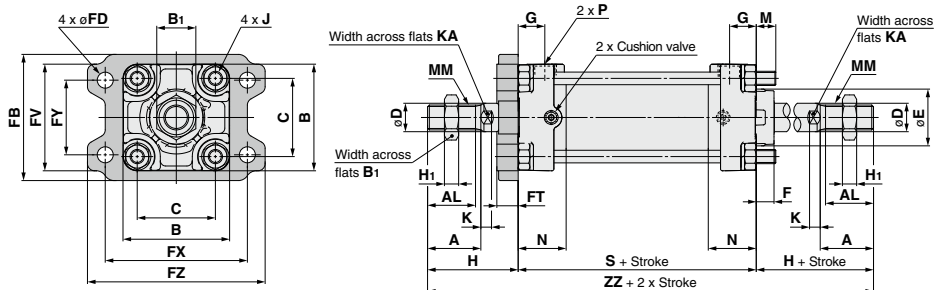

With rod boot

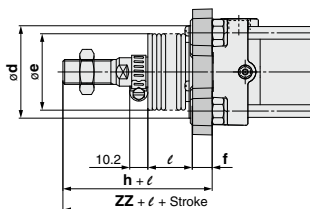

(mm)

Bore size (mm)	A	AL	B	B ₁	C	D	E	FB	FD	FT	FV	FX	FY	FZ	G	H ₁	J	K	KA	M
40	30	27	60	22	44	16	32	71	9	12	60	80	42	100	15	8	M8 x 1.25	6	14	11
50	35	32	70	27	52	20	40	81	9	12	70	90	50	110	17	11	M8 x 1.25	7	18	11
63	35	32	85	27	64	20	40	101	11.5	15	86	105	59	130	17	11	M10 x 1.25	7	18	14
80	40	37	102	32	78	25	52	119	13.5	18	102	130	76	160	21	13	M12 x 1.75	10	22	17
100	40	37	116	41	92	30	52	133	13.5	18	116	150	92	180	21	16	M12 x 1.75	10	26	17

Bore size (mm)	MM	N	P	S	Without rod boot		With rod boot (One side)						Both sides	
					H	ZZ	*d	e	f	h	ℓ	ZZ	ZZ	
40	M14 x 1.5	27	1/4	84	51	186	52	43	15	59	1/4 stroke	194	202	
50	M18 x 1.5	30	3/8	90	58	206	58	52	15	66	1/4 stroke	214	222	
63	M18 x 1.5	31	3/8	98	58	214	58	52	17.5	66	1/4 stroke	222	230	
80	M22 x 1.5	37	1/2	116	71	258	80	65	21.5	80	1/4 stroke	267	276	
100	M26 x 1.5	40	1/2	126	72	270	80	65	21.5	81	1/4 stroke	279	288	

★For installing an air cylinder, when a hole must be made to accommodate the rod portion, make sure to machine a hole that is larger than the outer diameter of the boot mounting bracket ød.

CA2W Series

Rod Flange: C□A2WF

Stroke of 1001 mm or more

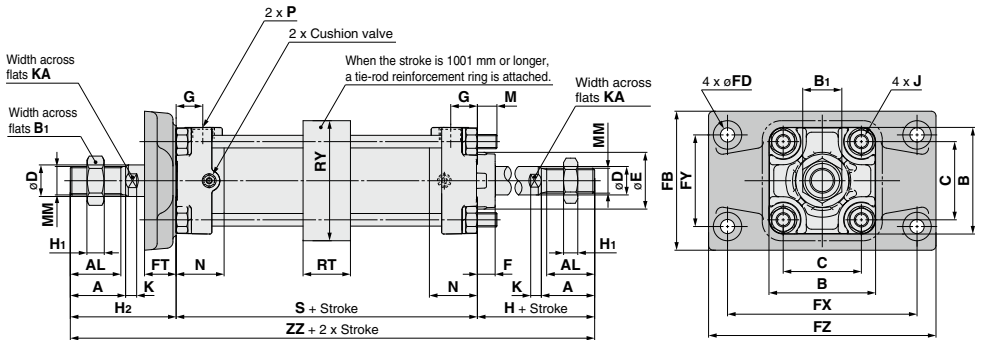

With rod boot

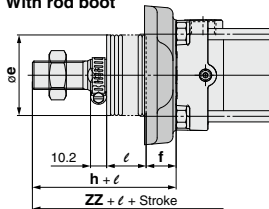

(mm)

Bore size (mm)	A	AL	B	B ₁	C	D	E	FB	FD	FT	FX	FY	FZ	G	H ₁	J	K	KA	M
40	30	27	60	22	44	16	32	71	9	12	80	42	100	15	8	M8 x 1.25	6	14	11
50	35	32	70	27	52	20	40	88	9	20	120	58	144	17	11	M8 x 1.25	7	18	6
63	35	32	85	27	64	20	40	105	11.5	23	140	64	170	17	11	M10 x 1.25	7	18	10
80	40	37	102	32	78	25	52	124	13.5	28	164	84	198	21	13	M12 x 1.75	10	22	12
100	40	37	116	41	92	30	52	140	13.5	29	180	100	220	21	16	M12 x 1.75	10	26	12

Bore size (mm)	MM	N	P	RT	RY	S	Without rod boot			With rod boot (One side)						(Both sides)	
							H	H ₂	ZZ	d	e	f	h	ℓ	ZZ	ZZ	
40	M14 x 1.5	27	1/4	30	76	84	51	51	186	52	43	15	59	1/4 stroke	194	202	
50	M18 x 1.5	30	3/8	30	76	90	58	67	215	58	52	19	66	1/4 stroke	214	222	
63	M18 x 1.5	31	3/8	40	92	98	58	71	227	58	52	19	66	1/4 stroke	222	230	
80	M22 x 1.5	37	1/2	45	112	116	71	87	274	80	65	21	80	1/4 stroke	266	276	
100	M26 x 1.5	40	1/2	50	136	126	72	89	287	80	65	21	81	1/4 stroke	279	288	

Note 1) For flange type with bore size of ø40, the same bracket is used for all strokes.

Note 2) For models with bore size of ø50 to ø100 and stroke of 1001 mm or more, do not mount a flange bracket on basic cylinders since H dimension is different from those shown above. When rod flange type is used, order with the part number with bracket.

Center Trunnion: C□A2WT

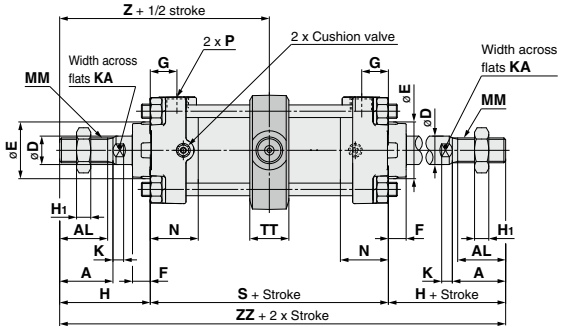
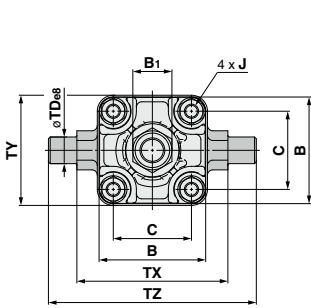

With rod boot

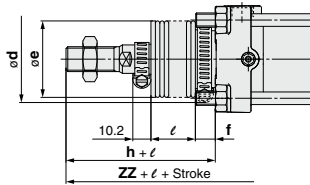

Bore size (mm)	A	AL	B	B ₁	C	D	E	F	G	H ₁	J	K	KA	MM	N	P	S	TD ₈₈
40	30	27	60	22	44	16	32	10	15	8	M8 x 1.25	6	14	M14 x 1.5	27	1/4	84	15 ^{+0.032} _{-0.059}
50	35	32	70	27	52	20	40	10	17	11	M8 x 1.25	7	18	M18 x 1.5	30	3/8	90	15 ^{+0.032} _{-0.059}
63	35	32	85	27	64	20	40	10	17	11	M10 x 1.25	7	18	M18 x 1.5	31	3/8	98	18 ^{+0.032} _{-0.059}
80	40	37	102	32	76	25	52	14	21	13	M12 x 1.75	10	22	M22 x 1.5	37	1/2	116	25 ^{+0.040} _{-0.073}
100	40	37	116	41	92	30	52	14	21	16	M12 x 1.75	10	26	M26 x 1.5	40	1/2	126	25 ^{+0.040} _{-0.073}

Bore size (mm)	TT	TX	TY	TZ	Without rod boot			With rod boot (One side)					(Both sides)			
					H	Z	ZZ	d	e	f	h	ℓ	Z	ZZ	Z	ZZ
40	22	85	62	117	51	93	186	56	43	11.2	59	1/4 stroke	101	194	101	202
50	22	95	74	127	58	103	206	64	52	11.2	66	1/4 stroke	111	214	111	222
63	28	110	90	148	58	107	214	64	52	11.2	66	1/4 stroke	115	222	115	230
80	34	140	110	192	71	129	258	76	65	12.5	80	1/4 stroke	138	267	138	276
100	40	162	130	214	72	135	270	76	65	14.0	81	1/4 stroke	144	279	144	288

* Do not disassemble the trunnion type. Refer to page 615.

Air Cylinder: Non-rotating Rod Type Double Acting, Single Rod

CA2K Series

ø40, ø50, ø63

How to Order

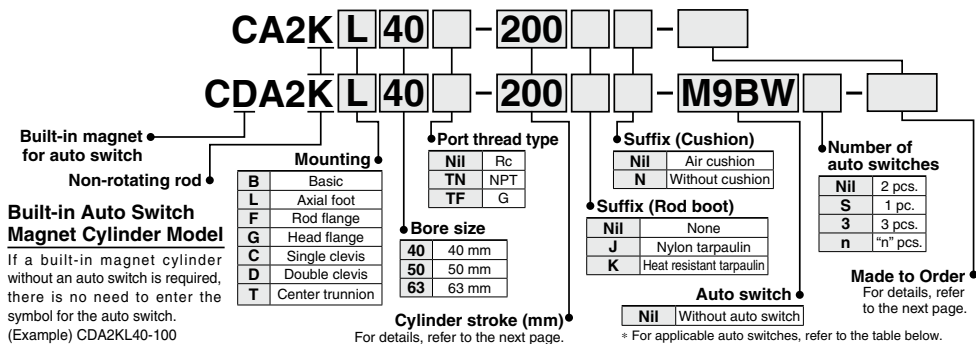

Applicable Auto Switches/Refer to pages 1271 to 1365 for further information on auto switches.

Type	Special function	Electrical entry	Indicator light	Wiring (Output)	Load voltage		Auto switch model		Lead wire length (m)					Pre-wired connector	Applicable load							
					DC	AC	Tie-rod mounting	Band mounting	0.5 (Nil)	1 (M)	3 (L)	5 (Z)	IC circuit		Relay, PLC							
Solid state auto switch	—	Grommet	No	3-wire (NPN)	24 V	5 V, 12 V	—	M9N	●	●	●	○	○	IC circuit	—	—						
				3-wire (PNP)				—	G59	●	—	●	○				○					
				2-wire				—	M9P	●	●	●	○				○					
				—				—	G5P	●	—	●	○				○					
	Diagnostic indication (2-color indicator)	Terminal conduit	Yes	3-wire (NPN)	24 V	12 V	—	G39C	G39	—	—	—	—	IC circuit	Relay, PLC							
				2-wire				—	K39C	K39	—	—	—			—						
				3-wire (NPN)				—	M9NW	—	●	●	●			○	○					
				3-wire (PNP)				—	G59W	—	●	●	●			○	○					
	Water resistant (2-color indicator)	Grommet	No	2-wire	24 V	12 V	—	M9PW	—	●	●	●	○	○	—	—						
				3-wire (NPN)				—	G5PW	—	●	●	●	○			○					
3-wire (PNP)				—				M9BW	—	●	●	●	○	○								
2-wire				—				K59W	—	●	●	●	○	○								
With diagnostic output (2-color indicator)	Grommet	No	3-wire (NPN)	24 V	5 V, 12 V	—	M9NA*1	—	○	○	●	○	○	—	—							
			3-wire (PNP)				—	M9PA*1	—	○	○	●	○			○						
			2-wire				—	M9BA*1	—	○	○	●	○			○						
			—				—	G5BA*1	—	—	—	—	—			—						
Magnetic field resistant (2-color indicator)	Terminal conduit	Yes	4-wire (NPN)	24 V	5 V, 12 V	—	F59F	G59F	●	—	●	○	○	IC circuit	—							
			2-wire (Non-polar)				—	P3DWA	—	●	—	●	○	○								
			—				—	P4DW	—	—	—	—	●	●		○						
			—				—	A59W	B59W	●	—	●	—	—		—						
Reed auto switch	—	Grommet	Yes	3-wire (NPN equiv.)	24 V	5 V	—	A96	—	●	—	●	—	—	IC circuit	—						
				No				2-wire	24 V	12 V	100 V	A93	—	●	●		●	●	—	IC circuit	Relay, PLC	
											100 V or less	A90	—	●	—		—	—	—			
											100 V, 200 V	A54	B54	●	—		●	●	—			—
											200 V or less	A64	B64	●	—		●	—	—			—
				Yes				DIN terminal	No	2-wire	24 V	100 V, 200 V	A33C	A33	—		—	—	—	—	—	PLC
A34C	A34	—	—		—	—	—						—									
Yes	Grommet	No	2-wire	24 V	100 V, 200 V	A44C	A44	—	—	—	—	—	—	Relay, PLC								
						A59W	B59W	●	—	●	—	—			—							

*1 Water resistant type auto switches can be mounted on the above models, but in such case SMC cannot guarantee water resistance. Please contact SMC regarding water resistant types with the above model numbers.

* Lead wire length symbols: 0.5 m..... Nil (Example) M9NW * Solid state auto switches marked with "○" are produced upon receipt of order.

1 m..... M (Example) M9NWW
3 m..... L (Example) M9NWL
5 m..... Z (Example) M9NWX

* Since there are other applicable auto switches than listed above, refer to page 613 for details.

* For details about auto switches with pre-wired connector, refer to pages 1340 and 1341.

* The D-A9□/M9□□/P3DWA□ auto switches are shipped together, (but not assembled). (However, auto switch mounting brackets are assembled for the D-A9□/M9□□ before shipment.)

Non-rotating accuracy: $\pm 0.8^\circ$
Same mounting dimensions as those of standard cylinder

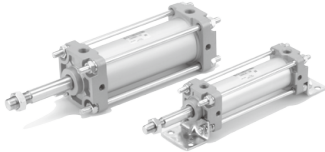

Symbol

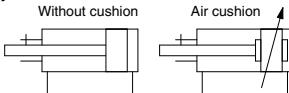

Made to Order
[Click here for details](#)

Symbol	Specifications
-XA□	Change of rod end shape
-XC7	Tie-rod, cushion valve, tie-rod nut, etc. made of stainless steel
-XC8	Adjustable stroke cylinder/Adjustable extension type
-XC9	Adjustable stroke cylinder/Adjustable retraction type
-XC10	Dual stroke cylinder/Double rod type
-XC11	Dual stroke cylinder/Single rod type
-XC14	Change of trunnion bracket mounting position
-XC15	Change of tie-rod length
-XC27	Double clevis and double knuckle joint pins made of stainless steel
-XC28	Compact flange made of SS400

Refer to pages 607 to 613 for cylinders with auto switches.

- Auto switch proper mounting position (detection at stroke end) and its mounting height
- Operating range
- Minimum stroke for auto switch mounting
- Auto switch mounting brackets/Part no.

Rod Boot Material

Symbol	Rod boot material	Max. ambient temperature
J	Nylon tarpaulin	70°C
K	Heat resistant tarpaulin	110°C*

* Maximum ambient temperature for the rod boot itself.
* The rod boot replacement part numbers are listed in the "Maintenance Parts List." [Click here](#) for further details.

Specifications

Bore size (mm)	40	50	63
Fluid	Air		
Proof pressure	1.5 MPa		
Maximum operating pressure	1.0 MPa		
Minimum operating pressure	0.05 MPa		
Ambient and fluid temperature	Without auto switch magnet : -10 to 70°C Built-in magnet for auto switch: -10 to 60°C*		
Piston speed	50 to 500 mm/s		
Cushion	Air cushion or Without air cushion		
Stroke length tolerance	Up to 250 st.*: ± 0.10 251 to 1000 st: 0 to +1.4		
Rod non-rotating accuracy	$\pm 0.8^\circ$		
Allowable rotational torque	0.44 N-m or less		
Lubrication	Not required (Non-lube)		
Mounting	Basic, Axial foot, Rod flange, Head flange Single clevis, Double clevis, Center trunnion		

* No freezing

Standard Strokes

Bore size	Standard stroke	Stroke range (mm) (Note 3)
40	25, 50, 75, 100, 125, 150, 175, 200, 250, 300, 350, 400, 450, 500	1 to 1000
50, 63	25, 50, 75, 100, 125, 150, 175, 200, 250, 300, 350, 400, 450, 500, 600	

Note 1) Aside from the standard strokes, intermediate strokes (within stroke range) are also available in 1 mm increments and are produced upon receipt of order.
Note 2) Applicable strokes should be confirmed according to the usage. For details, refer to "Air Cylinders Model Selection" on front matter pages. In addition, the products that exceed the standard stroke might not be able to fulfill the specifications due to the deflection etc.
Note 3) The stroke range for the type with a rod boot is shown in the table below. Strokes exceeding those in the table below are only available as a special order.

Bore size	Stroke range
40 to 63	20 to 1000 mm

Minimum Stroke for Auto Switch Mounting

⚠ Caution

1. The minimum stroke for mounting varies with the auto switch type and cylinder mounting type. In particular, the center trunnion type needs careful attention. (For details, refer to pages 611 and 612.)

Weights

Bore size (mm)	40	50	63	
Basic weight	Basic	0.88	1.32	1.91
	Axial foot	1.07	1.54	2.25
	Flange	1.25	1.77	2.70
	Single clevis	1.11	1.66	2.54
	Double clevis	1.15	1.75	2.70
	Trunnion	1.24	1.80	2.71
Additional weight per 50 mm of stroke	0.20	0.25	0.30	
Accessories	Single knuckle	0.23	0.26	0.26
	Double knuckle (with pin)	0.37	0.43	0.43

Calculation: (Example) **CA2KL40-100**
 • Basic weight..... 1.07 (Axial foot, ø40)
 • Additional weight... 0.20/50 stroke
 • Cylinder stroke 100 stroke
 1.07 + 0.20 x 100/50 = **1.47 kg**

Mounting Bracket Part No.

Bore size (mm)	40	50	63
Axial foot*	CA2-L04	CA2-L05	CA2-L06
Flange	CA2-F04	CA2-F05	CA2-F06
Single clevis	CA2-C04	CA2-C05	CA2-C06
Double clevis**	CA2-D04	CA2-D05	CA2-D06

* When axial foot brackets are used, order two pieces per cylinder.
** A clevis pin, flat washers and split pins are shipped together with double clevis.

⚠ Precautions

Be sure to read this before handling the products. Refer to page 20 for safety instructions and pages 21 to 30 for actuator and auto switch precautions.

Handling

⚠ Caution

1. Avoid applications in which rotational torque is applied to the piston rod.

If rotational torque is applied, the non-rotating guide will be deformed, resulting in a loss of non-rotating accuracy. Also, to screw a bracket or a nut onto the threaded portion at the end of the piston rod, make sure that the piston rod is fully retracted, and place a wrench on the parallel section of the rod that protrudes.

To tighten, take precautions to prevent the tightening torque from being applied to the non-rotating guide.

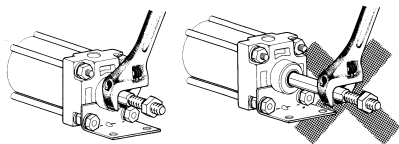

Disassembly/Replacement

⚠ Caution

1. When replacing the rod seal, assemble so that the width across flats of the seal matches the width across flats of the non-rotating guide. If they do not match, air leakage may occur.
2. Since the non-rotating guide is press fitted, it cannot be replaced individually.

Construction

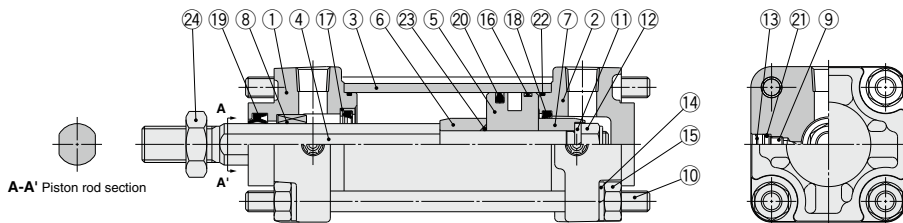

Component Parts

No.	Description	Material	Note
1	Rod cover	Aluminum alloy	Metallic painted
2	Head cover	Aluminum die-casted	Metallic painted
3	Cylinder tube	Aluminum alloy	Hard anodized
4	Piston rod	Carbon steel	Hard chrome plating
5	Piston	Aluminum alloy	Chromated
6	Cushion ring A	Rolled steel	Zinc chromated
7	Cushion ring B	Rolled steel	Zinc chromated
8	Non-rotating guide	Oil-impregnated sintered alloy	
9	Cushion valve	Steel wire	Trivalent zinc chromated
10	Tie-rod	Carbon steel	Trivalent zinc chromated
11	Spring washer	Steel wire	Trivalent zinc chromated
12	Piston nut	Rolled steel	Trivalent zinc chromated
13	Retaining ring	Spring steel	Phosphate coating
14	Spring washer	Steel wire	Trivalent zinc chromated
15	Tie-rod nut	Rolled steel	Trivalent zinc chromated
16	Wear ring	Resin	

No.	Description	Material	Note
17	Cushion seal holder	Aluminum alloy	
18	Cushion seal	Urethane	
19	Rod seal	NBR	
20	Piston seal	NBR	
21	Cushion valve seal	NBR	
22	Cylinder tube gasket	NBR	
23	Piston gasket	NBR	O-ring
24	Rod end nut	Rolled steel	Trivalent zinc chromated

Replacement Parts: Seal Kit

Bore size (mm)	Kit no.	Contents
40	CA2K40-PS	Set of the nos. 18, 19, 20, 22.
50	CA2K50-PS	
63	CA2K63-PS	

* Seal kit includes 18, 19, 20 and 22. Order the seal kit based on each bore size.
 * Do not disassemble the trunion type. Refer to page 615.

* Seal kit includes a grease pack (ø40, ø50: 10 g, over ø63: 20 g).

Order with the following part number when only the grease pack is needed.

Grease pack part number: GR-S-010 (10 g), GR-S-020 (20 g)

Basic: C□A2KB

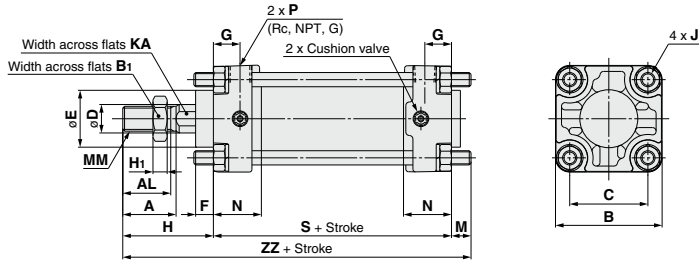

With rod boot

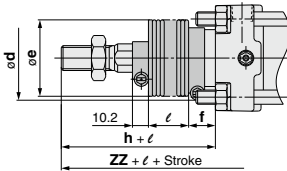

(mm)

Bore size (mm)	A	AL	B	B ₁	C	D	E	F	G	H _i	J	KA	M	MM
40	30	27	60	22	44	16	32	10	15	8	M8 x 1.25	14	11	M14 x 1.5
50	35	32	70	27	52	20	40	10	17	11	M8 x 1.25	18	11	M18 x 1.5
63	35	32	85	27	64	20	40	10	17	11	M10 x 1.25	18	14	M18 x 1.5

Bore size (mm)	N	P	S	Without rod boot		With rod boot					
				H	ZZ	d	e	f	h	ℓ	ZZ
40	27	1/4	84	51	146	56	43	11.2	59	1/4 stroke	154
50	30	3/8	90	58	159	64	52	11.2	66	1/4 stroke	167
63	31	3/8	98	58	170	64	52	11.2	66	1/4 stroke	178

The dimensions for each mounting type and the dimensions of accessories (options) are the same as the standard double acting single rod model. Refer to pages 566 to 575.

Air Cylinder: Non-rotating Rod Type

Double Acting, Double Rod

CA2KW Series

ø40, ø50, ø63

How to Order

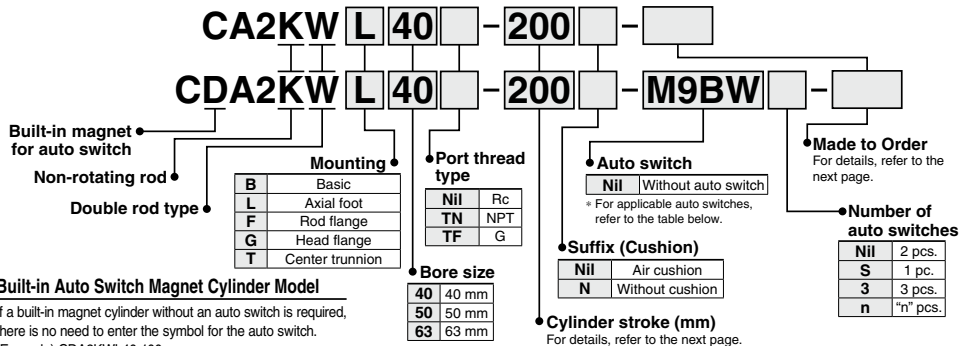

Built-in Auto Switch Magnet Cylinder Model

If a built-in magnet cylinder without an auto switch is required, there is no need to enter the symbol for the auto switch.
(Example) CDA2KW40-100

Applicable Auto Switches/Refer to pages 1271 to 1365 for further information on auto switches.

Type	Special function	Electrical entry	Indicator light	Wiring (Output)	Load voltage		Auto switch model		Lead wire length (m)					Pre-wired connector	Applicable load										
					DC	AC	Tie-rod mounting	Band mounting	0.5 (Nil)	1 (M)	3 (L)	5 (Z)													
Solid state auto switch	—	Grommet	—	3-wire (NPN)	24 V	5 V, 12 V	—	M9N	●	●	●	○	○	—	IC circuit										
				3-wire (PNP)				G59	●	●	●	○	○												
		2-wire		12 V	M9B	●	●	●	○	○	—	—													
		3-wire (NPN)			K59	●	●	●	○	○															
	Diagnostic indication (2-color indicator)	Terminal conduit	Yes	3-wire (NPN)	24 V	12 V	—	G39C	—	—	—	—	—	—	—										
								2-wire	G39	—	—	—	—			—									
		Grommet		3-wire (NPN)	5 V, 12 V	24 V	12 V	—	—	M9NW	●	●	●	○	○	IC circuit	Relay, PLC								
										3-wire (PNP)	G59W	●	●	●	○			○							
				2-wire	M9PW	●	●	●	○	○	—	—													
				3-wire (NPN)	G5PW	●	●	●	○	○															
Water resistant (2-color indicator)	Grommet	Yes	3-wire (NPN)	24 V	12 V	—	M9BW	●	●	●	○	○	—	—											
							3-wire (PNP)	K59W	●	●	●	○			○										
With diagnostic output (2-color indicator)	Grommet	Yes	4-wire (NPN)	5 V, 12 V	5 V, 12 V	—	M9NA*1	—	○	○	●	○	—	—											
							3-wire (PNP)	M9PA*1	—	○	○	●			○										
Magnetic field resistant (2-color indicator)	Grommet	Yes	2-wire (Non-polar)	—	12 V	—	M9BA*1	—	○	○	●	○	—	—											
							4-wire (NPN)	G5BA*1	—	○	○	●			○										
Reed auto switch	—	Grommet	Yes	3-wire (NPN equiv.)	24 V	12 V	—	A96	—	●	—	●	—	IC circuit	—										
								Terminal conduit	No	2-wire	100 V	A93	—			●	●	●	●	—	—				
												Yes	100 V or less			A90	—	●	—			●	—	IC circuit	Relay, PLC
													100 V, 200 V			A54	B54	●	—			●	●		
												DIN terminal	No			200 V or less	A64	B64	●			—	●	—	—
		100 V, 200 V	A33C	A33	—	—	—	—	—																
		Grommet	Yes	No	2-wire	—	—	—	A34C	A34	—	—	—	—	—	Relay, PLC									
									A44C	A44	—	—	—	—			—								
									A59W	B59W	—	—	—	—			—								
									—	—	—	—	—	—			—								
—	—								—	—	—	—	—												

*1 Water resistant type auto switches can be mounted on the above models, but in such case SMC cannot guarantee water resistance. Please contact SMC regarding water resistant types with the above model numbers.

* Lead wire length symbols: 0.5 m..... Nil (Example) M9NW * Solid state auto switches marked with "○" are produced upon receipt of order.

1 m..... M (Example) M9NWM
3 m..... L (Example) M9NWL
5 m..... Z (Example) M9NWX

* Since there are other applicable auto switches than listed above, refer to page 613 for details.

* For details about auto switches with pre-wired connector, refer to pages 1340 and 1341.

* The D-A9□/M9□□□□P3DWA□ auto switches are shipped together, (but not assembled). (However, auto switch mounting brackets are assembled for the D-A9□/M9□□□ before shipment.)

Non-rotating accuracy: $\pm 0.8^\circ$

Same mounting dimensions as those of standard cylinder

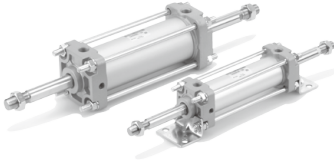

Symbol

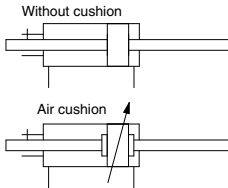

Made to Order

[Click here for details](#)

Symbol	Specifications
-XC7	Tie-rod, cushion valve, tie-rod nut, etc. made of stainless steel
-XC14	Change of trunnion bracket mounting position
-XC15	Change of tie-rod length
-XC28	Compact flange made of SS400

Refer to pages 607 to 613 for cylinders with auto switches.

- Auto switch proper mounting position (detection at stroke end) and its mounting height
- Operating range
- Minimum stroke for auto switch mounting
- Auto switch mounting brackets/Part no.

Production of Types with Rod Boot

CA2KW series is also available with rod boot. Please consult with SMC for more information.

Specifications

Bore size (mm)	40	50	63
Fluid	Air		
Proof pressure	1.5 MPa		
Maximum operating pressure	1.0 MPa		
Minimum operating pressure	0.08 MPa		
Ambient and fluid temperature	Without auto switch magnet : -10 to 70°C Built-in magnet for auto switch: -10 to 60°C*		
Piston speed	50 to 500 mm/s		
Cushion	Air cushion or Without air cushion		
Stroke length tolerance	Up to 250 st: $^{+0.15}$, 251 to 1000 st: 0 to +1.4		
Rod non-rotating accuracy	$\pm 0.8^\circ$		
Allowable rotational torque	0.44 N-m or less		
Lubrication	Not required (Non-lube)		
Mounting	Basic, Axial foot, Rod flange, Head flange, Center trunnion		

* No freezing

Standard Strokes

Bore size	Standard stroke	Stroke range (mm)
40	25, 50, 75, 100, 125, 150, 175, 200, 250, 300, 350, 400, 450, 500	1 to 1000
50, 63	25, 50, 75, 100, 125, 150, 175, 200, 250, 300, 350, 400, 450, 500, 600	

Note 1) Aside from the standard strokes, intermediate strokes (within stroke range) are also available in 1 mm increments and are produced upon receipt of order.

Note 2) Applicable strokes should be confirmed according to the usage. For details, refer to "Air Cylinders Model Selection" on front matter pages. In addition, the products that exceed the standard stroke might not be able to fulfill the specifications due to the deflection etc.

Minimum Stroke for Auto Switch Mounting

⚠ Caution

1. The minimum stroke for mounting varies with the auto switch type and cylinder mounting type. In particular, the center trunnion type needs careful attention. (For details, refer to pages 611 and 612.)

Weights/Aluminum Tube

Bore size (mm)	40	50	63	
Basic weight	Basic	1.01	1.54	2.17
	Axial foot	1.20	1.76	2.50
	Flange	1.38	1.99	2.96
	Trunnion	1.37	2.02	2.97
Additional weight per 50 mm of stroke		0.27	0.36	0.42
Accessories	Single knuckle	0.23	0.26	0.26
	Double knuckle (with pin)	0.37	0.43	0.43

Calculation: (Example) **CA2KWL40-100**

- Basic weight 1.20 (Axial foot, $\phi 40$)
- Additional weight 0.27/50 stroke
- Cylinder stroke 100 stroke

$$1.20 + 0.27 \times 100/50 = 1.74 \text{ kg}$$

Mounting Bracket Part No.

Bore size (mm)	40	50	63
Axial foot*	CA2-L04	CA2-L05	CA2-L06
Flange	CA2-F04	CA2-F05	CA2-F06

* When axial foot brackets are used, order two pieces per cylinder.

CA2KW Series

Construction

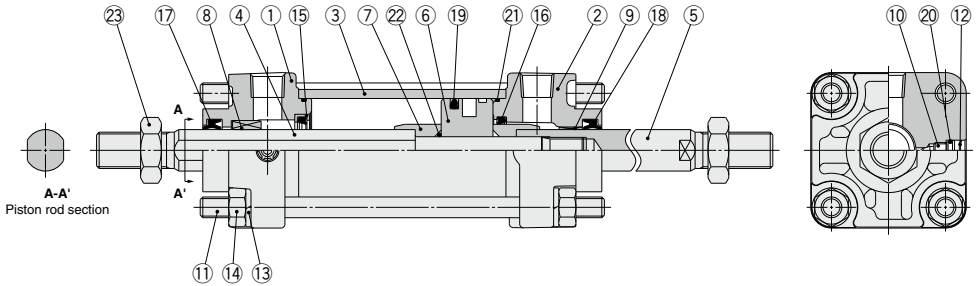

Component Parts

No.	Description	Material	Note
1	Rod cover A	Aluminum alloy	Metallic painted
2	Rod cover B	Aluminum die-casted	Metallic painted
3	Cylinder tube	Aluminum alloy	Hard anodized
4	Piston rod A	Carbon steel	Hard chrome plating
5	Piston rod B	Carbon steel	Hard chrome plating
6	Piston	Aluminum alloy	Chromated
7	Cushion ring	Rolled steel	Zinc chromated
8	Non-rotating guide	Oil-impregnated sintered alloy	
9	Bushing	Bearing alloy	
10	Cushion valve	Steel wire	Trivalent zinc chromated
11	Tie-rod	Carbon steel	Trivalent zinc chromated
12	Retaining ring	Spring steel	Phosphate coating
13	Spring washer	Steel wire	Trivalent zinc chromated
14	Tie-rod nut	Rolled steel	Trivalent zinc chromated
15	Cushion seal holder	Aluminum alloy	
16	Cushion seal	Urethane	
17	Rod seal A	NBR	
18	Rod seal B	NBR	
19	Piston seal	NBR	
20	Cushion valve seal	NBR	
21	Cylinder tube gasket	NBR	
22	Piston gasket	NBR	O-ring
23	Rod end nut	Rolled steel	Trivalent zinc chromated

Replacement Parts: Seal Kit

Bore size (mm)	Kit no.	Contents
40	CA2KW40-PS	Set of the nos. 16, 17, 18, 19, 21.
50	CA2KW50-PS	
63	CA2KW63-PS	

* Seal kit includes 16, 17, 18, 19, and 21. Order the seal kit based on each bore size.

* Do not disassemble the trunnion type. Refer to page 615.

* Seal kit includes a grease pack (ø40, ø50: 10 g, ø63, ø80: 20 g, ø100: 30 g).

Order with the following part number when only the grease pack is needed.
Grease pack part number: GR-S-010 (10 g), GR-S-020 (20 g)

Air Cylinder: Non-rotating Rod Type Double Acting, Double Rod **CA2KW Series**

Basic: C□A2KWB

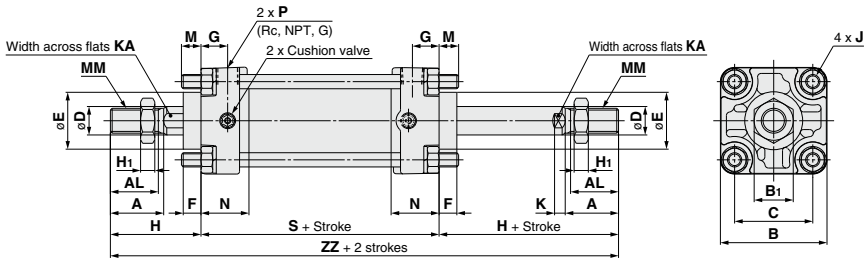

(mm)

Bore size (mm)	A	AL	B	B ₁	C	D	E	F	G	H ₁	J	K	KA	M	MM	N	P	S	H	ZZ
40	30	27	60	22	44	16	32	10	15	8	M8 x 1.25	6	14	11	M14 x 1.5	27	1/4	84	51	186
50	35	32	70	27	52	20	40	10	17	11	M8 x 1.25	7	18	11	M18 x 1.5	30	3/8	90	58	206
63	35	32	85	27	64	20	40	10	17	11	M10 x 1.25	7	18	14	M18 x 1.5	31	3/8	98	58	214

The dimensions for each mounting type are the same as the standard double acting double rod model. Refer to pages 580 to 583. For details about accessories (options), refer to page 575.

Air Cylinder: With End Lock

CBA2 Series

ø40, ø50, ø63, ø80, ø100

How to Order

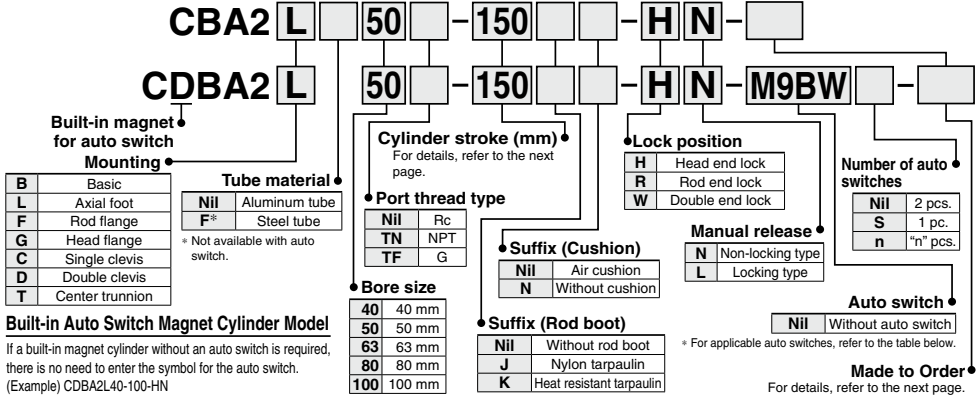

Applicable Auto Switches/Refer to pages 1271 to 1365 for further information on auto switches.

Type	Special function	Electrical entry	Indicator light	Wiring (Output)	Load voltage		Auto switch model		Lead wire length (m)				Pre-wired connector	Applicable load		
					DC	AC	Tie-rod mounting	Band mounting	0.5 (Nil)	1 (M)	3 (L)	5 (Z)				
Solid state auto switch	—	Grommet	—	3-wire (NPN)	24 V	5 V, 12 V	—	M9N	●	●	●	○	○	IC circuit	—	
				3-wire (PNP)				G59	●	●	●	○	○			
				2-wire				M9P	●	●	●	○	○			
				3-wire (NPN)				G5P	●	●	●	○	○			
				2-wire				M9B	●	●	●	○	○			
				3-wire (PNP)				K59	●	●	●	○	○			
	Diagnostic indication (2-color indicator)	Terminal conduit	Yes	—	3-wire (NPN)	12 V	5 V, 12 V	—	G39C	●	●	●	○	○	IC circuit	Relay, PLC
					2-wire				G39	●	●	●	○	○		
					3-wire (NPN)				K39	●	●	●	○	○		
					3-wire (PNP)				M9NW	●	●	●	○	○		
					2-wire				G59W	●	●	●	○	○		
					3-wire (PNP)				M9PW	●	●	●	○	○		
Water resistant (2-color indicator)	Grommet	—	—	2-wire	24 V	12 V	—	M9B	●	●	●	○	○	—	—	
				3-wire (NPN)				K59W	●	●	●	○	○			
				3-wire (PNP)				M9NA ^{*1}	—	○	○	○	○			
				2-wire				M9PA ^{*1}	—	○	○	○	○			
				2-wire				M9BA ^{*1}	—	○	○	○	○			
				4-wire (NPN)				G5BA ^{*1}	—	○	○	○	○			
With diagnostic output (2-color indicator) Magnetic field resistant (2-color indicator)	Grommet	—	—	2-wire	24 V	12 V	—	F59F	●	●	●	○	○	IC circuit	—	
				2-wire (Non-polar)				G59F	●	●	●	○	○			
				3-wire (NPN equiv.)				P3DWA	●	●	●	○	○			
				—				P4DW	●	●	●	○	○			
				—				A96	●	●	●	○	○			
				—				A93	●	●	●	○	○			
Reed auto switch	—	Grommet	Yes	3-wire (NPN equiv.)	24 V	12 V	—	A93	●	●	●	○	○	IC circuit	Relay, PLC	
								A90	●	●	●	○	○			
								A54	B54	●	●	●	○			○
								A64	B64	●	●	●	○			○
								A33C	A33	—	—	—	—			—
								A34C	A34	—	—	—	—			—
								A44C	A44	—	—	—	—			—
								A59W	B59W	●	●	●	○			○
Diagnostic indication (2-color indicator)	Grommet	Yes	—	—	—	—	—	A96	●	●	●	○	○	IC circuit	—	
								A93	●	●	●	○	○			

*1 Water resistant type auto switches can be mounted on the above models, but in such case SMC cannot guarantee water resistance. Please contact SMC regarding water resistant types with the above model numbers.

* Lead wire length symbols: 0.5 m..... Nil (Example) M9NW
1 m..... M (Example) M9NWM
3 m..... L (Example) M9NWL
5 m..... Z (Example) M9NWX

* Solid state auto switches marked with "○" are produced upon receipt of order.

* Since there are other applicable auto switches than listed above, refer to page 613 for details.

* For details about auto switches with pre-wired connector, refer to pages 1340 and 1341.

* The D-A9□/M9□□/P3DWA□ auto switches are shipped together, (but not assembled). (However, auto switch mounting brackets are assembled for the D-A9□/M9□□ before shipment.)

Maintains the cylinder's original position even if the air supply is interrupted.

When air is discharged at the stroke end position, the lock engages to maintain the rod in that position.

Same dimensions as those of the standard cylinder (CA2 series)
Non-locking and locking types are standard for manual release.

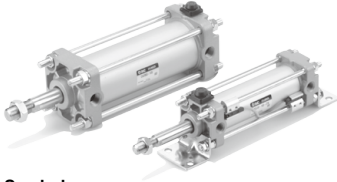

Symbol

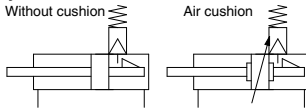

Made to Order
[Click here for details](#)

Symbol	Specifications
-XA □	Change of rod end shape
-XB6	Heat resistant cylinder (-10 to 150°C)
-XC3	Special port location
-XC4 *1	With heavy duty scraper
-XC6 *1	Made of stainless steel
-XC7	Tie-rod, cushion valve, tie-rod nut, etc. made of stainless steel
-XC8 *1	Adjustable stroke cylinder/Adjustable extension type
-XC9 *2	Adjustable stroke cylinder/Adjustable retraction type
-XC10	Dual stroke cylinder/Double rod type
-XC14	Change of trunnion bracket mounting position
-XC15	Change of tie-rod length
-XC22	Fluororubber seal
-XC27	Double clevis and double knuckle joint pins made of stainless steel
-XC28	Compact flange made of SS400
-XC29	Double knuckle joint with spring pin
-XC30	Rod trunnion
-XC35	With coil scraper

*1 For head end lock only

*2 For rod end lock only

Refer to pages 607 to 613 for cylinders with auto switches.

- Auto switch proper mounting position (detection at stroke end) and its mounting height
- Operating range
- Minimum stroke for auto switch mounting
- Auto switch mounting brackets/Part no.

Specifications

Bore size (mm)	40	50	63	80	100
Fluid	Air				
Proof pressure	1.5 MPa				
Maximum operating pressure	1.0 MPa				
Minimum operating pressure	0.15 MPa*1				
Ambient and fluid temperature	Without auto switch magnet : -10 to 70°C*2 Built-in magnet for auto switch: -10 to 60°C*2				
Piston speed	50 to 500 mm/s				
Cushion	Air cushion or Without air cushion				
Stroke length tolerance	Up to 250 st: $^{+1.0}_{-0}$ 251 to 1000 st: $^{+1.4}_{-0}$ 1001 to 1500 st: $^{+1.8}_{-0}$ 1501 to 1800 st: 0 to +2.2				
Lubrication	Not required (Non-lube)				
Mounting	Basic, Axial foot, Rod flange, Head flange, Single clevis, Double clevis, Center trunnion				

*1 0.05 MPa except locking parts.

*2 No freezing

Lock Specifications

Lock position	Head end, Rod end, Double end				
Holding force (Max.) (N)	ø40 860	ø50 1340	ø63 2140	ø80 3450	ø100 5390
Backlash	2 mm or less				
Manual release	Non-locking type, Locking type				

Accessories / Refer to page 575 for part numbers and dimensions.

Accessories	Standard			Option		
	Rod end nut	Clevis pin	Lock release bolt (N type only)	Single knuckle joint	Double knuckle joint (with pin)	Rod boot
Mounting						
Basic	●	—	●	●	●	●
Axial foot	●	—	●	●	●	●
Rod flange	●	—	●	●	●	●
Head flange	●	—	●	●	●	●
Single clevis	●	—	●	●	●	●
Double clevis*	●	●	●	●	●	●
Center trunnion	●	—	●	●	●	●

* Double clevis and double knuckle joint types are packed with pin, split pin and flat washer.

Standard Strokes

Bore size	Standard stroke	Stroke range ^{Note 3)}	
		Rod end lock Double end lock	Head end lock
40	25, 50, 75, 100, 125, 150, 175, 200, 250, 300, 350, 400, 450, 500	1 to 1800	1 to 1800
50	25, 50, 75, 100, 125, 150, 175, 200, 250, 300, 350, 400, 450, 500, 600		
63	25, 50, 75, 100, 125, 150, 175, 200, 250, 300, 350, 400, 450, 500, 600		
80, 100	25, 50, 75, 100, 125, 150, 175, 200, 250, 300, 350, 400, 450, 500, 600, 700	1 to 1500	

Note 1) Aside from the standard strokes, intermediate strokes (within stroke range) are also available in 1 mm increments and are produced upon receipt of order.

Note 2) Applicable strokes should be confirmed according to the usage. For details, refer to "Air Cylinders Model Selection" on front matter pages. In addition, the products that exceed the standard stroke might not be able to fulfill the specifications due to the deflection etc.

Note 3) The stroke range for the type with a rod boot is shown in the table below. Strokes exceeding those in the table below are only available as a special order.

Bore size	Stroke range (mm)	
	Rod end lock Double end lock	Head end lock
40, 50	20 to 1800	20 to 1800
63, 80, 100	20 to 1200	

Minimum Stroke for Auto Switch Mounting

⚠ Caution

1. The minimum stroke for mounting varies with the auto switch type and cylinder mounting type. In particular, the center trunnion type needs careful attention. (For details, refer to pages 611 and 612.)

CBA2 Series

Rod Boot Material

Symbol	Rod boot material	Max. ambient temperature
J	Nylon tarpaulin	70°C
K	Heat resistant tarpaulin	110°C*

* Maximum ambient temperature for the rod boot itself.

* The rod boot replacement part numbers are listed in the "Maintenance Parts List." [Click here](#) for further details.

Mounting Bracket Part No.

Bore size (mm)	40	50	63	80	100
Axial foot*	CA2-L04	CA2-L05	CA2-L06	CA2-L08	CA2-L10
Flange	CA2-F04	CA2-F05	CA2-F06	CA2-F08	CA2-F10
Single clevis	CA2-C04	CA2-C05	CA2-C06	CA2-C08	CA2-C10
Double clevis**	CA2-D04	CA2-D05	CA2-D06	CA2-D08	CA2-D10

* When axial foot brackets are used, order two pieces per cylinder.

** A clevis pin, flat washers and split pins are shipped together with double clevis.

Weights/Aluminum Tube (Steel Tube)

Bore size (mm)		40	50	63	80	100
Basic weight	Basic	0.89 (0.94)	1.36 (1.40)	2.00 (2.04)	3.48 (3.63)	4.87 (5.07)
	Axial foot	1.08 (1.13)	1.58 (1.62)	2.34 (2.38)	4.15 (4.30)	5.86 (6.06)
	Flange	1.26 (1.30)	1.81 (1.86)	2.79 (2.84)	4.93 (5.08)	6.79 (6.99)
	Single clevis	1.12 (1.17)	1.70 (1.74)	2.63 (2.67)	4.59 (4.74)	6.65 (6.86)
	Double clevis	1.16 (1.21)	1.79 (1.84)	2.79 (2.83)	4.88 (5.03)	7.17 (7.38)
	Trunnion	1.25 (1.35)	1.84 (1.94)	2.80 (3.00)	5.03 (5.32)	7.15 (7.54)
Additional weight per 50 mm of stroke	All mounting brackets (Except steel tube trunnion)	0.22 (0.28)	0.28 (0.35)	0.37 (0.43)	0.52 (0.70)	0.65 (0.87)
	Steel tube trunnion	(0.36)	(0.46)	(0.65)	(0.86)	(1.07)
Accessories	Single knuckle	0.23	0.26	0.26	0.60	0.83
	Double knuckle (with pin)	0.37	0.43	0.43	0.87	1.27

* Values inside the parentheses are those for the steel tube type.

Lock Unit Additional Weights

Bore size (mm)		40	50	63	80	100
Non-locking type manual release (N)	Head end lock (H)	0.02	0.03	0.03	0.10	0.12
	Rod end lock (R)	0.02	0.02	0.02	0.07	0.06
	Double end lock (W)	0.04	0.05	0.05	0.17	0.18
Locking type manual release (L)	Head end lock (H)	0.04	0.05	0.05	0.13	0.15
	Rod end lock (R)	0.04	0.04	0.04	0.10	0.09
	Double end lock (W)	0.08	0.09	0.09	0.23	0.24

Calculation: (Example) **CBA2L40-100-HN**

- Basic weight..... 1.08 kg (ø40, Axial foot)
 - Additional weight.... 0.22/50 stroke
 - Cylinder stroke 100 stroke
 - Lock unit weight 0.02 kg
(Head end lock, Non-locking type manual release)
- $$1.08 + 0.22 \times 100/50 + 0.02 = 1.54 \text{ kg}$$

Construction

Head end lock

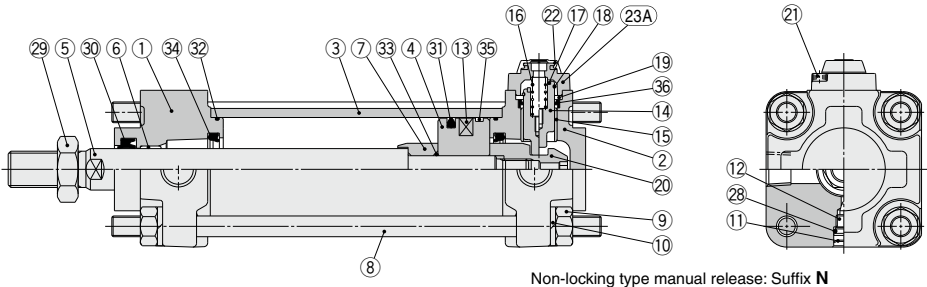

Non-locking type manual release: Suffix N

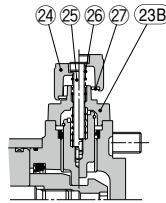

Locking type manual release: Suffix L

Component Parts

No.	Description	Material	Note
1	Rod cover	Aluminum die-casted	Metallic painted
2	Head cover	Aluminum die-casted	Metallic painted
3	Cylinder tube	Aluminum alloy	Hard anodized
4	Piston	Aluminum alloy	Chromated
5	Piston rod	Carbon steel	Hard chrome plating
6	Bushing	Bearing alloy	
7	Cushion ring A	Rolled steel	Electroless nickel plating
8	Tie-rod	Carbon steel	Zinc chromated
9	Tie-rod nut	Rolled steel	Trivalent zinc chromated
10	Spring washer	Steel wire	Trivalent zinc chromated
11	Retaining ring	Spring steel	Phosphate coating
12	Cushion valve	Steel wire	Trivalent zinc chromated
13	Magnet*	—	* With auto switch
14	Lock piston	Carbon steel	Quench hard chrome plating
15	Lock bushing	Lead-bronze casted	
16	Lock spring	Stainless steel	
17	Bumper	Urethane	
18	C-ring	Steel wire	Zinc chromated
19	Seal retainer	Rolled steel	Zinc chromated
20	Cushion ring nut	Chromium molybdenum steel	Quench, Electroless nickel plating
21	Hexagon socket head cap screw	Chromium molybdenum steel	Black zinc chromated
22	Rubber cap	Chloroprene rubber	
23A	Cap A	Aluminum casted	Black coated
23B	Cap B	Carbon steel	Oxide film treated

No.	Description	Material	Note
24	M/O knob	Zinc die-casted	Black coated
25	M/O bolt	Chromium molybdenum steel	Black zinc chromated, Red painted
26	M/O spring	Steel wire	Zinc chromated
27	Stopper ring	Carbon steel	Zinc chromated
28	Cushion valve seal	NBR	
29	Rod end nut	Rolled steel	Trivalent zinc chromated
30	Rod seal	NBR	
31	Piston seal	NBR	
32	Cylinder tube gasket	NBR	
33	Piston gasket	NBR	
34	Cushion seal	NBR	
35	Wear ring	Resin	
36	Lock piston seal	NBR	

Replacement Parts: Seal Kit

Bore size (mm)	Kit no.		Contents
	One end lock	Double end lock	
40	MBB40-PS	MBB40-PS-W	Set of the nos. 30, 31, 32, 34, 36.
50	MBB50-PS	MBB50-PS-W	
63	MBB63-PS	MBB63-PS-W	
80	MBB80-PS	MBB80-PS-W	
100	MBB100-PS	MBB100-PS-W	

* Seal kit includes 30, 31, 32, 34 and 36. Order the seal kit based on each bore size.

* Do not disassemble the trunnion type. Refer to page 615.

* Seal kit includes a grease pack (ø40, ø50: 10 g, ø63, ø80: 20 g, ø100: 30 g). Order with the following part number when only the grease pack is needed. Grease pack part number: GR-S-010 (10 g), GR-S-020 (20 g)

CBA2 Series

Basic (Dimensions are common to head end lock, rod end lock and double end lock types.)

Head end lock: C□BA2B Bore size - Stroke -HN

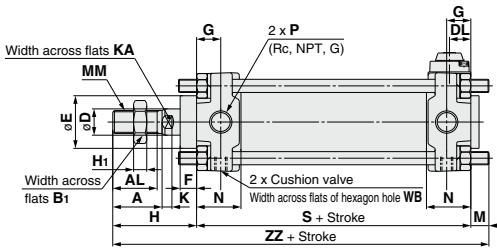

Non-locking type manual release:
Suffix N

Locking type manual release:
Suffix L

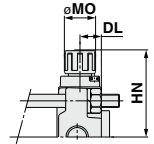
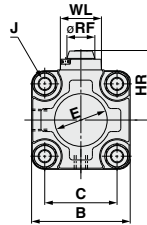

Rod end lock: C□BA2B Bore size - Stroke -RN

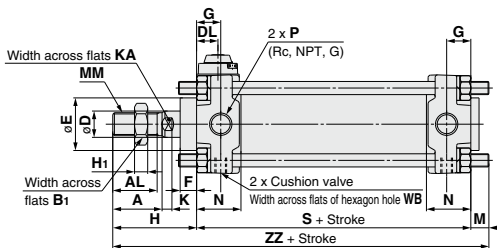

Non-locking type manual release:
Suffix N

Locking type manual release:
Suffix L

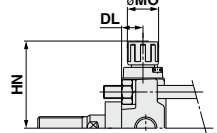
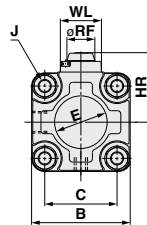

Double end lock: C□BA2B Bore size - Stroke -WN

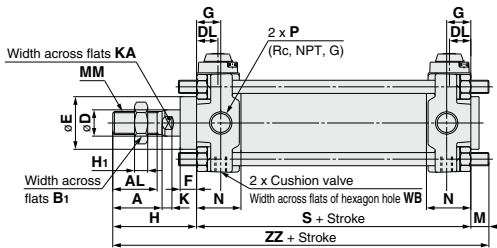

Non-locking type manual release:
Suffix N

Locking type manual release:
Suffix L

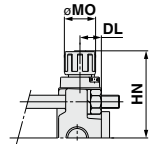
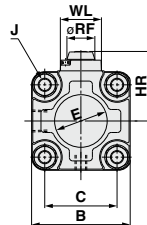

With rod boot

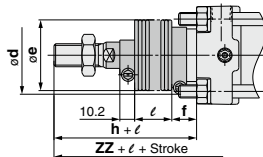

With Rod Boot

Bore size (mm)	d	e	f	h	ℓ	ZZ
40	56	43	11.2	59	1/4 stroke	154
50	64	52	11.2	66	1/4 stroke	167
63	64	52	11.2	66	1/4 stroke	178
80	76	65	12.5	80	1/4 stroke	213
100	76	65	14	81	1/4 stroke	224

Bore size (mm)	A	AL	B	B ₁	C	D	DL	E	F	G	H	H _i	HR	HN (Max.)	J	K	KA	M	MM	MO	N	P	RF	S	WB	WL	ZZ
40	30	27	60	22	44	16	13	32	10	15	51	8	42.3	56	M8 x 1.25	6	14	11	M14 x 1.5	19	27	1/4	17	84	2.5	25	146
50	35	32	70	27	52	20	13	40	12	17	58	11	47.3	61	M8 x 1.25	7	18	11	M18 x 1.5	19	30	3/8	17	90	2.5	25	159
63	35	32	85	27	64	20	15.5	40	10	17	58	11	54.8	68.5	M10 x 1.25	7	18	14	M18 x 1.5	19	31	3/8	17	98	4	25	170
80	40	37	102	32	78	25	18.5	52	14	21	71	13	65.8	80.5	M12 x 1.75	11	22	17	M22 x 1.5	23	37	1/2	21	116	4	40	204
100	40	37	116	41	92	30	20	52	14	21	72	16	72.8	87.5	M12 x 1.75	11	26	17	M26 x 1.5	23	40	1/2	21	126	4	40	215

The dimensions for each mounting type and the dimensions of accessories (options) are the same as the standard double acting single rod model. Refer to pages 566 to 575.



CBA2 Series

Specific Product Precautions

Be sure to read this before handling the products. Refer to page 20 for safety instructions and pages 21 to 30 for actuator and auto switch precautions.

Use the Recommended Pneumatic Circuit

⚠ Caution

This is necessary for proper operation and release of the lock.

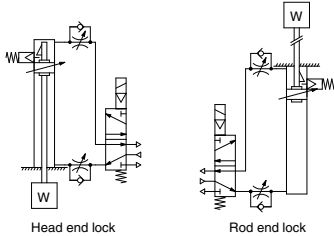

Handling

⚠ Caution

1. Do not use a 3 position solenoid valve.

Avoid using this cylinder in combination with a 3 position solenoid valve (particularly the closed center metal seal type). If air pressure becomes sealed inside the port on the lock mechanism side, the cylinder cannot be locked. Even if the lock is released at first, the air that leaks from the solenoid valve could enter the cylinder and cause the lock to release as time elapses.

2. Back pressure is required to release end lock.

Be sure air is supplied to the side of the cylinder without a lock mechanism (side of the piston rod without lock for double end lock), before starting up, as in the above figures. Otherwise, the lock may not be released. (Refer to "Releasing the Lock".)

3. Release the lock when mounting or adjusting the cylinder.

If mounting or other work is performed when the cylinder is locked, the lock unit may be damaged.

4. Operate with a load ratio of 50% or less.

If the load ratio exceeds 50%, this may cause problems such as failure of the lock to release, or damage to the lock unit.

5. Do not operate multiple synchronized cylinders.

Avoid applications in which two or more cylinders with end lock are synchronized to move one workpiece, as one of the cylinder locks may not be able to release when required.

6. Use a speed controller with meter-out control.

If operated under meter-in control, the lock may not be released.

7. Be sure to operate completely to the cylinder stroke end on the side with the lock.

The lock may not be engaged or released if the piston in the cylinder has not reached the stroke end.

Operating Pressure

⚠ Caution

1. Supply air pressure of 0.15 MPa or higher to the port on the lock mechanism side, as it is necessary for releasing the lock.

Exhaust Speed

⚠ Caution

1. When the pressure on the lock mechanism side drops to 0.05 MPa or below, the lock engages automatically. If the piping on the lock mechanism side is thin and long, or if the speed controller is away from the cylinder port, the lock engagement may take some time due to decline of the exhaust speed. The same result will be caused by clogging of the silencer installed at the EXH port of the solenoid valve.

Relation to Cushion

⚠ Caution

1. When the cushion valve on the lock mechanism side is fully closed or almost closed, the piston rod may not be able to reach the stroke end, resulting in lock engagement failure. Furthermore, if the lock becomes engaged while the cushion valve is almost fully closed, it may become impossible to be released. Therefore, the cushion valve must be adjusted properly.

Releasing the Lock

⚠ Caution

1. To release the lock, make sure to supply air pressure to the port on the side without a lock mechanism, thus preventing the load from being applied to the lock mechanism. (Refer to the recommended pneumatic circuits.) If the lock is released, while the port on the side without a lock mechanism is in the exhausted state and the load is being applied to the lock mechanism, undue force may be applied to the lock mechanism, causing the lock mechanism to be damaged. Also, it could be extremely dangerous, because the piston rod could move suddenly.

Manual Release

⚠ Caution

1. Non-locking type manual release

Insert the bolt, which is provided as an accessory, through the rubber cap (it is not necessary to remove the rubber cap). Screw the bolt into the lock piston and pull the bolt to release the lock. Releasing the bolt will re-engage the lock.

The bolt size, pulling force, and the stroke are listed below.

Bore size (mm)	Thread size	Pulling force	Stroke (mm)
40, 50, 63	M3 x 0.5 x 30 L or more	10 N	3
80, 100	M5 x 0.8 x 40 L or more	24.5 N	3

* Remove the bolt for normal operation.

* It can cause lock malfunction or faulty release.

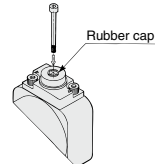

2. Locking type manual release

Push the M/O knob and turn it 90° counterclockwise. The lock is released when the ▲ mark on the cap is aligned with the ▼ OFF mark on the M/O knob (and the lock will remain released).

To engage the lock, push the M/O knob all the way in and turn it 90° clockwise to align the ▲ mark on the cap with the ▼ ON mark on the M/O knob. At this time, make sure that the knob stops by clicking into place.

Failure to click it into place properly can cause the lock to release.

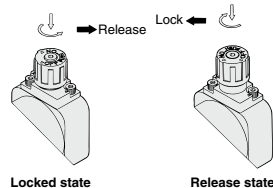

Air Cylinder: Air-hydro Type Double Acting, Single Rod

CA2□H Series

ø40, ø50, ø63, ø80, ø100

How to Order

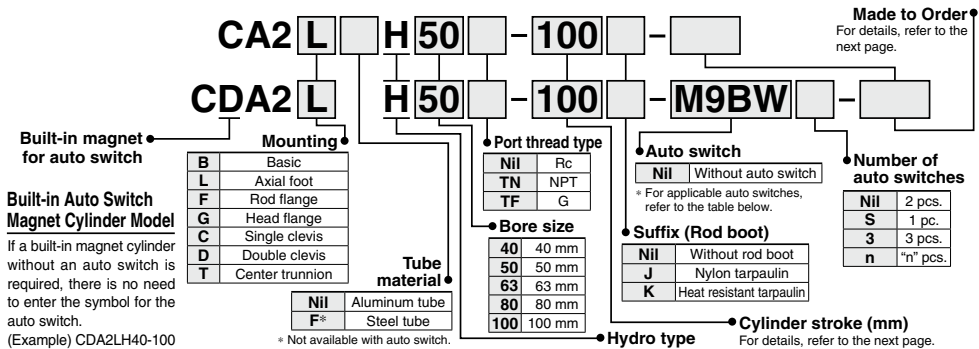

Applicable Auto Switches/Refer to pages 1271 to 1365 for further information on auto switches.

Type	Special function	Electrical entry	Indicator/light	Wiring (Output)	Load voltage		Auto switch model		Lead wire length (m)					Pre-wired connector	Applicable load	
					DC	AC	Tie-rod mounting	Band mounting	0.5 (Nil)	1 (M)	3 (L)	5 (Z)				
Solid state auto switch	—	Grommet	—	3-wire (NPN)	24 V	5 V, 12 V	—	M9N	●	●	●	○	○	IC circuit	—	
				3-wire (PNP)				G59	●	—	●	○	○			
				2-wire	G5P	●	—	●	○	○						
		Terminal conduit		3-wire (NPN)	12 V	—	M9B	—	●	●	●	○	○			
				2-wire			K59	●	—	●	○	○				
				3-wire (NPN)	24 V	5 V, 12 V	—	G39C	G39	—	—	—	—	—		IC circuit
	2-wire	K39	—	—				—	—	—						
	Diagnostic indication (2-color indicator)	Grommet	Yes	—	3-wire (NPN)	24 V	5 V, 12 V	—	M9NW	—	●	●	●	○	○	IC circuit
					3-wire (PNP)				G59W	●	—	●	○	○		
					2-wire	M9PW	—	●	●	●	○	○				
		Terminal conduit			2-wire	12 V	—	M9BW	—	●	●	●	○	○		
					3-wire (NPN)			24 V	5 V, 12 V	—	K59W	—	●	—	●	○
3-wire (PNP)					M9NA*1	—	○				○	●	○	○		
Water resistant (2-color indicator)	Grommet	—	—	2-wire	12 V	—	—	M9PA*1	—	○	○	●	○	○	—	
				3-wire (PNP)				M9BA*1	—	○	○	●	○	○		
				Terminal conduit	2-wire	12 V	—	—	M9BA*1	—	○	○	●	○	○	
	3-wire (NPN)				G5BA*1				—	—	●	○	○			
	3-wire (PNP)				F59F	G59F	●	—	●	○	○					
	With diagnostic output (2-color indicator)			Grommet	—	—	2-wire (Non-polar)	24 V	5 V, 12 V	—	P3DWA	—	●	—	●	●
3-wire (NPN equiv.)		P4DW	—				—				—	—	—	—		
Terminal conduit		2-wire	12 V				—	—	A96**	—	●	—	●	—	—	IC circuit
		3-wire		A93**					—	●	●	●	—	—		
		DIN terminal	2-wire	24 V			12 V	—	A90**	—	●	—	●	—	—	IC circuit
3-wire			A54						B54	●	—	●	●	—	—	
Grommet	2-wire		12 V	—	—	A33C	A33	—	—	—	—	—	—			
	3-wire	A34C				A34	—	—	—	—	—	—				
	2-wire	24 V	100 V, 200 V	—	—	A44C	A44	—	—	—	—	—	Relay, PLC			
3-wire	A59W					B59W	●	—	●	—	—	—				

*1 Water resistant type auto switches can be mounted on the above models, but in such case SMC cannot guarantee water resistance. Please contact SMC regarding water resistant types with the above model numbers.

* Lead wire length symbols: 0.5 m..... Nil (Example) M9NW * Solid state auto switches marked with "○" are produced upon receipt of order.
1 m..... M (Example) M9NW **D-A9□ and D-A9□V types cannot be mounted on ø50. Use D-Z7□ and D-Z80 instead.
3 m..... L (Example) M9WL
5 m..... Z (Example) M9NWZ

* Since there are other applicable auto switches than listed above, refer to page 613 for details.

* For details about auto switches with pre-wired connector, refer to pages 1340 and 1341.

* The D-A9□/M9□□/P3D□□ auto switches are shipped together, (but not assembled). (However, auto switch mounting brackets are assembled for the D-A9□/M9□□ before shipment.)

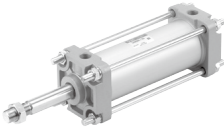

Symbol

Double acting, without cushion

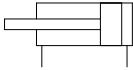

Made to Order
[Click here for details](#)

Symbol	Specifications
-XA□	Change of rod end shape
-XC6	Made of stainless steel
-XC7	Tie-rod, cushion valve, tie-rod nut, etc. made of stainless steel
-XC14	Change of trunnion bracket mounting position
-XC15	Change of tie-rod length
-XC27	Double clevis and double knuckle joint pins made of stainless steel
-XC28	Compact flange made of SS400
-XC29	Double knuckle joint with spring pin
-XC65	Made of stainless steel (Combination of XC7 and XC68)

Note) Since a heavy duty scraper (-XC4) is installed as standard, there is no need to specify it.

⚠ Precautions

Setting

⚠ Caution

- Do not use the cylinder near fire or on equipment or machinery whose ambient temperature exceeds 60°C. Since the air-hydro cylinder uses flammable hydraulic fluid, there is danger of potential fire.

Selection

⚠ Caution

- Keep the air-hydro cylinder load at 50% or less than the theoretical output. For the air-hydro cylinder to achieve performance that is close to that of the hydraulic cylinder in constant-speed operation and stopping accuracy, the load must be kept at 50% or less than theoretical output.

Refer to pages 607 to 613 for cylinders with auto switches.

- Auto switch proper mounting position (detection at stroke end) and its mounting height
- Operating range
- Minimum stroke for auto switch mounting
- Auto switch mounting brackets/Part no.

Specifications

Bore size (mm)	40	50	63	80	100
Type	Air-hydro				
Fluid	Turbine oil				
Action	Double acting				
Proof pressure	1.5 MPa				
Maximum operating pressure	1.0 MPa				
Ambient and fluid temperature	5 to 60°C				
Minimum operating pressure	0.1 MPa				
Piston speed	0.5 to 300 mm/s				
Cushion	None				
Stroke length tolerance	Up to 250 st: $^{+1.0}_0$ 251 to 1000 st: $^{+1.4}_0$ 1001 to 1500 st: $^{+1.8}_0$ 1501 to 1800 st: 0 to +2.2				
Mounting	Basic, Foot, Rod flange, Head flange, Single clevis, Double clevis, Center trunnion				

Standard Strokes

Bore size	Standard stroke (mm)	Stroke range ^{Note 3)}
40	25, 50, 75, 100, 125, 150, 175, 200, 250, 300, 350, 400, 450, 500	1 to 1800
50, 63	25, 50, 75, 100, 125, 150, 175, 200, 250, 300, 350, 400, 450, 500, 600	
80, 100	25, 50, 75, 100, 125, 150, 175, 200, 250, 300, 350, 400, 450, 500, 600, 700	

Note 1) Aside from the standard strokes, intermediate strokes (within stroke range) are also available in 1 mm increments and are produced upon receipt of order.
Note 2) Applicable strokes should be confirmed according to the usage. For details, refer to "Air Cylinders Model Selection" on front matter pages. In addition, the products that exceed the standard stroke might not be able to fulfill the specifications due to the deflection etc.

Note 3) The stroke range for the type with a rod boot is shown in the table below. Strokes exceeding those in the table below are only available as a special order.

Bore size	Stroke range
40 to 100	20 to 1800 mm

Minimum Stroke for Auto Switch Mounting

⚠ Caution

- The minimum stroke for mounting varies with the auto switch type and cylinder mounting type. In particular, the center trunnion type needs careful attention. (For details, refer to pages 611 and 612.)

Accessories

Mounting	Basic	Axial foot	Rod flange	Head flange	Single clevis	Double clevis	Center trunnion
Standard	Rod end nut ●	Rod end nut ●	Clevis pin —	Clevis pin —	Single knuckle joint ●	Double knuckle joint (with pin) ●	With rod boot ●
Option	Single knuckle joint ●	Double knuckle joint (with pin) ●	With rod boot ●	Single clevis ●	Double clevis ●	Center trunnion ●	

* Refer to page 575 for part numbers and dimensions.

Rod Boot Material

Symbol	Rod boot material	Max. ambient temperature
J	Nylon tarpaulin	70°C
K	Heat resistant tarpaulin	110°C*

* Maximum ambient temperature for the rod boot itself.

* The rod boot replacement part numbers are listed in the "Maintenance Parts List." [Click here](#) for further details.

Weights/Aluminum Tube (Steel Tube)

Bore size (mm)		40	50	63	80	100	
Basic weight	Basic	0.89 (0.94)	1.36 (1.40)	2.00 (2.04)	3.48 (3.63)	4.87 (5.07)	
	Axial foot	1.08 (1.13)	1.58 (1.62)	2.34 (2.38)	4.15 (4.30)	5.86 (6.06)	
	Flange	1.26 (1.30)	1.81 (1.86)	2.79 (2.84)	4.93 (5.08)	6.79 (6.99)	
	Single clevis	1.12 (1.17)	1.70 (1.74)	2.63 (2.67)	4.59 (4.74)	6.65 (6.86)	
	Double clevis	1.16 (1.21)	1.79 (1.83)	2.79 (2.83)	4.88 (5.03)	7.17 (7.38)	
	Trunnion	1.25 (1.35)	1.84 (1.94)	2.80 (3.00)	5.03 (5.32)	7.15 (7.54)	
	Additional weight per 50 mm of stroke	All mounting brackets (Except steel tube trunnion)	0.22 (0.28)	0.28 (0.35)	0.37 (0.43)	0.52 (0.70)	0.65 (0.87)
	Accessories	Steel tube trunnion	(0.36)	(0.46)	(0.65)	(0.86)	(1.07)
	Single knuckle	0.23	0.26	0.26	0.60	0.83	
	Double knuckle (with pin)	0.37	0.43	0.43	0.87	1.27	

Calculation:
(Example)

CA2LH40-100
(Axial foot, ø40, 100 stroke)

- Basic weight1.08 kg
 - Additional weight0.22/50 stroke
 - Cylinder stroke100 stroke
- 1.08 + 0.22 x 100/50 = **1.52 kg**
- * Values inside the parentheses are those for the steel tube type.

CA2□H Series

Mounting Bracket Part No.

Bore size (mm)	40	50	63	80	100
Axial foot*	CA2-L04	CA2-L05	CA2-L06	CA2-L08	CA2-L10
Flange	CA2-F04	CA2-F05	CA2-F06	CA2-F08	CA2-F10
Single clevis	CA2-C04	CA2-C05	CA2-C06	CA2-C08	CA2-C10
Double clevis**	CA2-D04	CA2-D05	CA2-D06	CA2-D08	CA2-D10

* When axial foot brackets are used, order two pieces per cylinder.

** A clevis pin, flat washers and split pins are shipped together with double clevis.

Construction

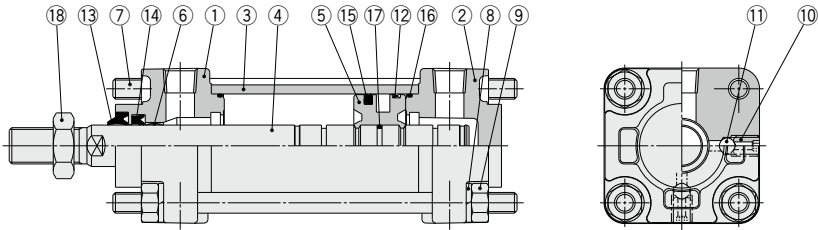

Component Parts

No.	Description	Material	Note
1	Rod cover	Aluminum alloy	Metallic painted
2	Head cover	Aluminum alloy	Metallic painted
3	Cylinder tube	Aluminum alloy	Hard anodized
4	Piston rod	Carbon steel	Hard chrome plating
5	Piston	Aluminum alloy	Chromated
6	Bushing	Bearing alloy	
7	Tie-rod	Carbon steel	Trivalent zinc chromated
8	Spring washer	Rolled steel	Trivalent zinc chromated
9	Tie-rod nut	Rolled steel	Trivalent zinc chromated
10	Air release valve	Chromium molybdenum steel	Black zinc chromated
11	Check ball	Bearing steel	
12	Wear ring	Resin	
13	Scraper	NBR	
14	Rod seal	NBR	
15	Piston seal	NBR	
16	Cylinder tube gasket	NBR	
17	Piston gasket	NBR	
18	Rod end nut	Rolled steel	Trivalent zinc chromated

Replacement Parts: Seal Kit

Bore size (mm)	Kit no.		Contents
	Air-hydro type		
40	CA2H40A-PS		Set of the nos. ⑭, ⑮, ⑯.
50	CA2H50A-PS		
63	CA2H63A-PS		
80	CA2H80A-PS		
100	CA2H100A-PS		

* Do not disassemble the trunnion type. Refer to page 615.

* Seal kit includes ⑭, ⑮ and ⑯. Order the seal kit based on each bore size.

* Seal kit includes a grease pack (ø40, ø50: 10 g, ø63 or more: 20 g).

Order with the following part number when only the grease pack is needed.

Grease pack part number: GR-S-010 (10 g), GR-S-020 (20 g)

Basic: C□A2BH

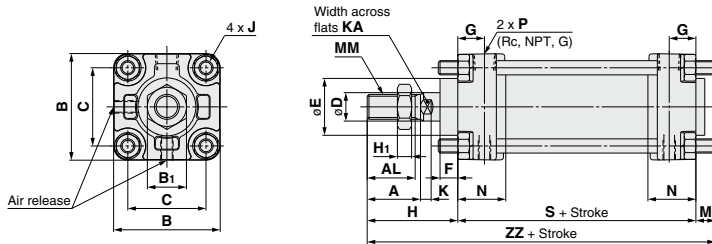

With rod boot

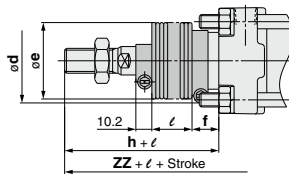

Bore size (mm)	A	AL	B	B ₁	C	D	E	F	G	H ₁	J	K	KA	M	MM	N	P
40	30	27	60	22	44	16	32	10	15	8	M8 x 1.25	6	14	11	M14 x 1.5	27	1/4
50	35	32	70	27	52	20	40	10	17	11	M8 x 1.25	7	18	11	M18 x 1.5	30	3/8
63	35	32	85	27	64	20	40	10	17	11	M10 x 1.25	7	18	14	M18 x 1.5	31	3/8
80	40	37	102	32	78	25	52	14	21	13	M12 x 1.75	10	22	17	M22 x 1.5	37	1/2
100	40	37	116	41	92	30	52	14	21	16	M12 x 1.75	10	26	17	M26 x 1.5	40	1/2

Bore size (mm)	S	Without rod boot		With rod boot					
		H	ZZ	d	e	f	h	ℓ	ZZ
40	84	51	146	56	43	11.2	59	1/4 stroke	154
50	90	58	159	64	52	11.2	66	1/4 stroke	167
63	98	58	170	64	52	11.2	66	1/4 stroke	178
80	116	71	204	76	65	12.5	80	1/4 stroke	213
100	126	72	215	76	65	14	81	1/4 stroke	224

The dimensions for each mounting type and the dimensions of accessories (options) are the same as the standard double acting single rod model. Refer to pages 566 to 575.

Air Cylinder: Air-hydro Type

Double Acting, Double Rod

CA2W□H Series

ø40, ø50, ø63, ø80, ø100

How to Order

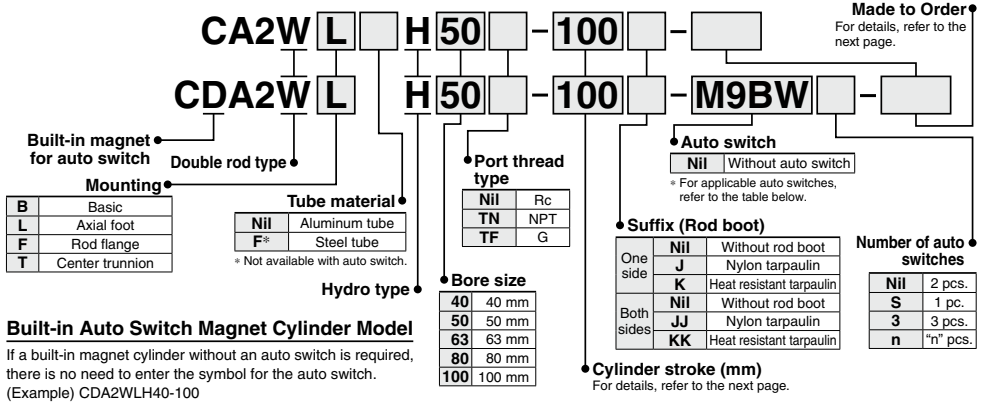

Built-in Auto Switch Magnet Cylinder Model

If a built-in magnet cylinder without an auto switch is required, there is no need to enter the symbol for the auto switch.
 (Example) CDA2WLH40-100

Applicable Auto Switches/Refer to pages 1271 to 1365 for further information on auto switches.

Type	Special function	Electrical entry	Indicator/light	Wiring (Output)	Load voltage		Auto switch model		Lead wire length (m)					Pre-wired connector	Applicable load
					DC	AC	Tie-rod mounting	Band mounting	0.5 (Nil)	1 (M)	3 (L)	5 (Z)			
Solid state auto switch	—	Grommet	—	3-wire (NPN)	24 V	5 V, 12 V	—	M9N	●	●	●	○	○	IC circuit	—
				3-wire (PNP)				G59	●	●	●	○	○		
				2-wire				M9P	●	●	●	○	○		
				—				G5P	●	●	●	○	○		
				—				M9B	●	●	●	○	○		
				—				K59	●	●	●	○	○		
	Diagnostic indication (2-color indicator)	Terminal conduit	Yes	3-wire (NPN)	12 V	5 V, 12 V	—	G39C	●	●	●	○	○	IC circuit	Relay, PLC
				2-wire				G39	●	●	●	○	○		
				3-wire (NPN)				K39C	●	●	●	○	○		
				3-wire (PNP)				M9NW	●	●	●	○	○		
				2-wire				G59W	●	●	●	○	○		
				—				M9PW	●	●	●	○	○		
Water resistant (2-color indicator)	Grommet	—	2-wire	24 V	12 V	—	M9BW	●	●	●	○	○	—	—	
			3-wire (NPN)				K59W	●	●	●	○	○			
			3-wire (PNP)				M9NA*1	—	○	○	○	○			
			2-wire				M9PA*1	—	○	○	○	○			
			—				M9BA*1	—	○	○	○	○			
			—				G5BA*1	—	○	○	○	○			
With diagnostic output (2-color indicator) Magnetic field resistant (2-color indicator)	Grommet	—	4-wire (NPN)	24 V	5 V, 12 V	—	F59F	●	●	●	○	○	IC circuit	—	
			2-wire (Non-polar)				P3DWA	●	●	●	○	○			
			—				P4DW	●	●	●	○	○			
			—				A96**	—	●	●	●	○			
			—				A93**	—	●	●	●	○			
			—				A90**	—	●	●	●	○			
Reed auto switch	Grommet	Yes	3-wire (NPN equiv.)	24 V	12 V	—	A54	●	●	●	○	○	IC circuit	Relay, PLC	
							—	A64	●	●	●	○			○
							—	A33C	●	●	●	○			○
							—	A34C	●	●	●	○			○
							—	A44C	●	●	●	○			○
							—	A59W	●	●	●	○			○
Diagnostic indication (2-color indicator)	Terminal conduit DIN terminal	Yes	2-wire	24 V	12 V	—	B54	●	●	●	○	○	—	PLC	
							—	B64	●	●	●	○			○
							—	A33C	●	●	●	○			○
							—	A34C	●	●	●	○			○
							—	A44C	●	●	●	○			○
							—	A59W	●	●	●	○			○
Diagnostic indication (2-color indicator)	Grommet	Yes	3-wire (NPN equiv.)	24 V	12 V	—	B59W	●	●	●	○	○	—	Relay, PLC	
							—	B64	●	●	●	○			○
							—	A33C	●	●	●	○			○
							—	A34C	●	●	●	○			○
							—	A44C	●	●	●	○			○
							—	A59W	●	●	●	○			○

*1 Water resistant type auto switches can be mounted on the above models, but in such case SMC cannot guarantee water resistance.
 Please contact SMC regarding water resistant types with the above model numbers.

* Lead wire length symbols: 0.5 m..... Nil (Example) M9NW
 1 m..... M (Example) M9NWM
 3 m..... L (Example) M9NLW
 5 m..... Z (Example) M9NWZ

* Solid state auto switches marked with "○" are produced upon receipt of order.
 **D-A9□ and D-A9□V types cannot be mounted on ø50. Use D-Z7□ and D-Z80 instead.

* Since there are other applicable auto switches than listed above, refer to page 613 for details.

* For details about auto switches with pre-wired connector, refer to pages 1340 and 1341.

* The D-A9□/M9□□□/P3DW□ auto switches are shipped together, (but not assembled). (However, auto switch mounting brackets are assembled for the D-A9□/M9□□□ before shipment.)

Air Cylinder: Air-hydro Type Double Acting, Double Rod **CA2W□H Series**

Specifications

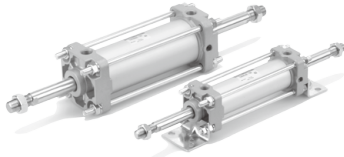

Bore size (mm)	40	50	63	80	100
Type	Air-hydro				
Fluid	Turbine oil				
Action	Double acting				
Proof pressure	1.5 MPa				
Maximum operating pressure	1.0 MPa				
Minimum operating pressure	0.16 MPa				
Piston speed	0.5 to 300 mm/s				
Ambient and fluid temperature	5 to 60°C				
Cushion	None				
Stroke length tolerance	Up to 250 st: ^{+1.0} ₀ , 251 to 750 st: ^{+1.4} ₀				
Mounting	Basic, Axial foot, Rod flange, Center trunnion				

Standard Strokes

Bore size	Standard stroke					Stroke range (mm) Note 3)
	40	50	63	80	100	
40	25, 50, 75, 100, 125, 150, 175, 200, 250, 300, 350, 400, 450, 500					1 to 1800
50, 63	25, 50, 75, 100, 125, 150, 175, 200, 250, 300, 350, 400, 450, 500, 600					
80, 100	25, 50, 75, 100, 125, 150, 175, 200, 250, 300, 350, 400, 450, 500, 600, 700					

Note 1) Aside from the standard strokes, intermediate strokes (within stroke range) are also available in 1 mm increments and are produced upon receipt of order.

Note 2) Applicable strokes should be confirmed according to the usage. For details, refer to "Air Cylinders Model Selection" on front matter pages. In addition, the products that exceed the standard stroke might not be able to fulfill the specifications due to the deflection etc.

Note 3) The stroke range for the type with a rod boot is shown in the table below. Strokes exceeding those in the table below are only available as a special order.

Bore size	Stroke range
40 to 100	20 to 1400 mm

Symbol

Without cushion

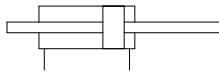

Made to Order
Click here for details

Symbol	Specifications
-XC6	Made of stainless steel
-XC7	Tie-rod, cushion valve, tie-rod nut, etc. made of stainless steel
-XC14	Change of trunnion bracket mounting position
-XC15	Change of tie-rod length
-XC28	Compact flange made of SS400
-XC65	Made of stainless steel (Combination of XC7 and XC68)

Note) Since a heavy duty scraper (-XC4) is installed as standard, there is no need to specify it.

Refer to pages 607 to 613 for cylinders with auto switches.

- Auto switch proper mounting position (detection at stroke end) and its mounting height
- Operating range
- Minimum stroke for auto switch mounting
- Auto switch mounting brackets/Part no.

Rod Boot Material

Symbol	Rod boot material	Max. ambient temperature
J	Nylon tarpaulin	70°C
K	Heat resistant tarpaulin	110°C*

* Maximum ambient temperature for the rod boot itself.

* The rod boot replacement part numbers are listed in the "Maintenance Parts List." [Click here](#) for further details.

Minimum Stroke for Auto Switch Mounting

⚠ Caution

1. The minimum stroke for mounting varies with the auto switch type and cylinder mounting type. In particular, the center trunnion type needs careful attention. (For details, refer to pages 611 and 612.)

Accessories

Standard	Mounting	Basic	Foot	Flange	Center trunnion
	Rod end nut	●	●	●	●
Option	Single knuckle joint	●	●	●	●
	Double knuckle joint (with pin)	●	●	●	●
	With rod boot	●	●	●	●

* Refer to page 575 for part numbers and dimensions.

Weights/Aluminum Tube (Steel Tube)

Bore size (mm)		40	50	63	80	100
		Basic weight	1.03 (1.08)	1.59 (1.64)	2.26 (2.30)	3.94 (4.09)
Basic weight	Axial foot	1.22 (1.27)	1.81 (1.86)	2.59 (2.63)	4.61 (4.76)	6.65 (6.77)
	Flange	1.40 (1.45)	2.05 (2.09)	3.05 (3.09)	5.39 (5.55)	7.49 (7.70)
	Trunnion	1.39 (1.49)	2.07 (2.18)	3.06 (3.25)	5.49 (5.78)	7.85 (8.24)
Additional weight per 50 mm of stroke	All mounting brackets (Except steel tube trunnion)	0.30 (0.35)	0.40 (0.47)	0.50 (0.55)	0.71 (0.89)	0.92 (1.15)
	Steel tube trunnion	(0.44)	(0.58)	(0.77)	(1.06)	(1.35)
Accessories	Single knuckle	0.23	0.26	0.26	0.60	0.83
	Double knuckle (with pin)	0.37	0.43	0.43	0.87	1.27

Calculation: (Example) **CA2WLH40-100** (Axial foot, ø40, 100 stroke) * Values inside the parentheses are those for the steel tube type.

- Basic weight 1.22 (Axial foot, ø40)
- Additional weight..... 0.30/50 stroke
- Cylinder stroke 100 stroke

$$1.22 + 0.30 \times 100/50 = 1.82 \text{ kg}$$

Mounting Bracket Part No.

Bore size (mm)	40	50	63	80	100
Axial foot*	CA2-L04	CA2-L05	CA2-L06	CA2-L08	CA2-L10
Flange	CA2-F04	CA2-F05	CA2-F06	CA2-F08	CA2-F10

* When axial foot brackets are used, order two pieces per cylinder.

CA2W□H Series

Construction

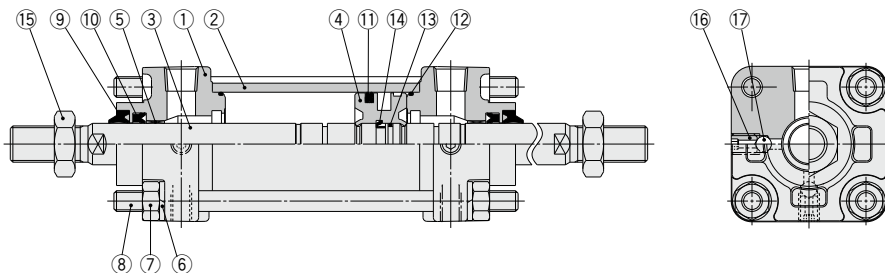

Component Parts

No.	Description	Material	Note
1	Rod cover	Aluminum alloy	Metallic painted
2	Cylinder tube	Aluminum alloy	Hard anodized
3	Piston rod	Carbon steel	Hard chrome plating
4	Piston	Aluminum alloy	Chromated
5	Bushing	Bearing alloy	
6	Spring washer	Rolled steel	Chromated
7	Tie-rod nut	Rolled steel	Nickel plating
8	Tie-rod	Carbon steel	Zinc chromated
9	Scraper	NBR	
10	Rod seal	NBR	
11	Piston seal	NBR	
12	Cylinder tube gasket	NBR	
13	Piston gasket	NBR	
14	Piston holder	Urethane	
15	Rod end nut	Rolled steel	Nickel plating
16	Air release valve	Chromium molybdenum steel	Black zinc chromated
17	Check ball	Bearing steel	

Replacement Parts: Seal Kit

Bore size (mm)	Kit no.	Contents
	Air-hydro type	
40	CA2WH40A-PS	Set of the nos. ⑩, ⑪, ⑫.
50	CA2WH50A-PS	
63	CA2WH63A-PS	
80	CA2WH80A-PS	
100	CA2WH100A-PS	

* Do not disassemble the trunnion type. Refer to page 615.

* Seal kit includes ⑩, ⑪ and ⑫. Order the seal kit based on each bore size.

* Seal kit includes a grease pack (ø40, ø50: 10 g, ø63 or more: 20 g).

Order with the following part number when only the grease pack is needed.

Grease pack part number: GR-S-010 (10 g), GR-S-020 (20 g)

Air Cylinder: Air-hydro Type Double Acting, Double Rod **CA2W□H Series**

Basic: C□A2WBH

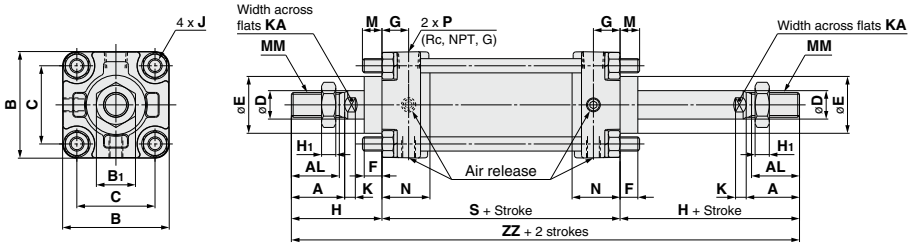

With rod boot (One side)

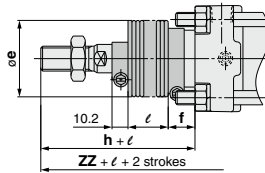

With rod boot (Both sides)

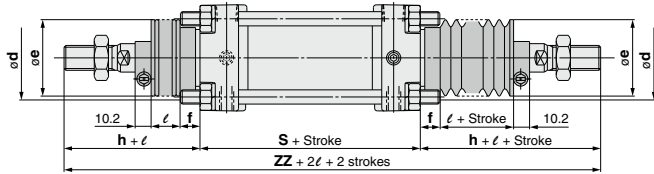

(mm)																
Bore size (mm)	A	AL	B	B ₁	C	D	E	F	G	H ₁	J	K	KA	M	MM	N
40	30	27	60	22	44	16	32	10	15	8	M8 x 1.25	6	14	11	M14 x 1.5	27
50	35	32	70	27	52	20	40	10	17	11	M8 x 1.25	7	18	11	M18 x 1.5	30
63	35	32	85	27	64	20	40	10	17	11	M10 x 1.25	7	18	14	M18 x 1.5	31
80	40	37	102	32	78	25	52	14	21	13	M12 x 1.75	11	22	17	M22 x 1.5	37
100	40	37	116	41	92	30	52	14	21	16	M12 x 1.75	11	26	17	M26 x 1.5	40

Bore size (mm)	P	S	Without rod boot		With rod boot (One side)						Both sides	
			H	ZZ	d	e	f	h	ℓ	ZZ	ZZ	
40	1/4	84	51	186	56	43	11.2	59	1/4 stroke	194	202	
50	3/8	90	58	206	64	52	11.2	66	1/4 stroke	214	222	
63	3/8	98	58	214	64	52	11.2	66	1/4 stroke	222	230	
80	1/2	116	71	258	76	65	12.5	80	1/4 stroke	267	276	
100	1/2	126	72	270	76	65	14.0	81	1/4 stroke	279	288	

The dimensions for each mounting type are the same as the standard double acting double rod model. Refer to pages 580 to 583. For details about accessories (options), refer to page 575.

CA2 Series Auto Switch Mounting

Auto Switch Proper Mounting Position (Detection at stroke end) and Its Mounting Height

<Band mounting>

D-B5□/B64/B59W

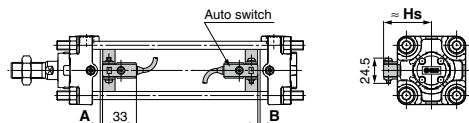

D-A3□
D-G39/K39

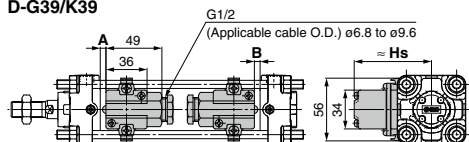

D-G5□/K59 D-G5BA
D-G5□W/K59W D-G59F/G5NT

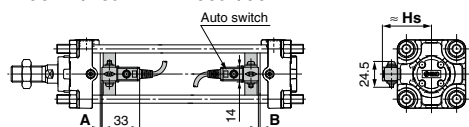

D-A44

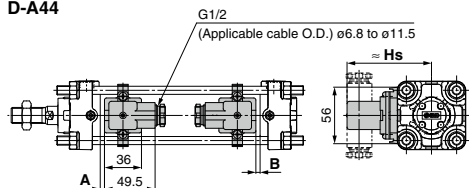

<Tie-rod mounting>

D-M9□/M9□V D-Y59□/Y69□/Y7P/Y7PV
D-M9□W/M9□WV D-Y7□W/Y7□WV
D-M9□A/M9□AV D-Y7BA
D-A9□/A9□V D-Z7□/Z80

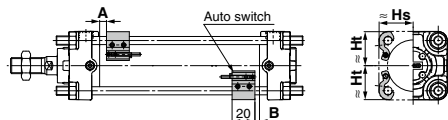

D-A5□/A6□
D-A59W

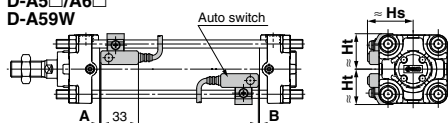

D-G39C/K39C
D-A3□C

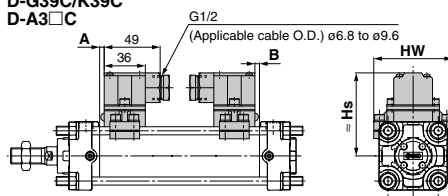

D-F5□/J59 D-F5□W/J59W
D-F5NT D-F5BA/F59F

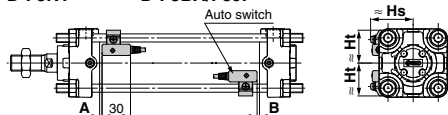

D-A44C

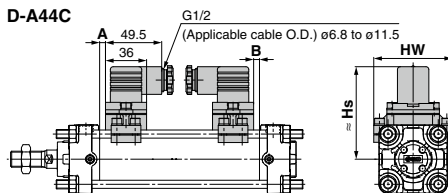

D-P3DWA

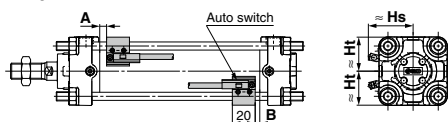

D-P4DW

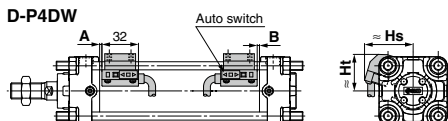

Auto Switch Proper Mounting Position (Detection at stroke end) and Its Mounting Height

Auto Switch Proper Mounting Position (Standard type)

(mm)

Auto switch model	D-M9□ D-M9□V D-M9□W D-M9□A D-M9□AV		D-A9□ D-A9□V		D-Y59□ D-Y69□ D-Y7P D-Y7PV D-Y7□W D-Y7□VW D-Y7BA D-Z7□ D-Z80 D-B59W		D-P3DWA		D-P4DW		D-F5□ D-J59 D-F59F D-F5□W D-J59W D-F5BA		D-F5NT		D-A59W		D-G39 D-G39C D-K39 D-K39C D-A5□ D-A6□ D-A3□ D-A3□C D-A44 D-A44C		D-G5□ D-K59 D-G5NT D-G5□W D-K59W D-G5BA D-G59F		D-B5□ D-B64		
	A	B	A	B	A	B	A	B	A	B	A	B	A	B	A	B	A	B	A	B	A	B	A
40	9	9	5	5	2.5	2.5	4.5	4.5	2	2	5.5	5.5	10.5	10.5	3	3	0	0	1	1	0	0	
50	9.5	8.5	5.5	4.5	3	2	5	4	2.5	1.5	6	5	11	10	3.5	2.5	0	0	1.5	0.5	0	0	
63	12.5	11.5	8.5	7.5	6	5	8	7	5.5	4.5	9	8	14	13	6.5	5.5	2.5	1.5	4.5	3.5	3	2	
80	16.5	13.5	12.5	9.5	10	7	12	9	9.5	6.5	13	10	18	15	10.5	7.5	6.5	3.5	8.5	5.5	7	4	
100	18	16	14	12	11.5	9.5	13.5	11.5	11	9	14.5	12.5	19.5	17.5	12	10	8	6	10	8	8.5	6.5	

Note) Adjust the auto switch after confirming the operating conditions in the actual setting.

Auto Switch Proper Mounting Height (Standard type)

(mm)

Auto switch model	D-M9□ D-M9□W D-M9□A D-A9□		D-M9□V D-M9□VW D-M9□AV		D-A9□V		D-Y59□ D-Y7P D-Y7BA D-Y7□W D-Z7□ D-Z80		D-Y69□ D-Y7PV D-Y7□VW		D-P3DWA		D-P4DW		D-G5□ D-K59 D-G5NT D-G5□W D-K59W D-G5BA D-G59F D-B5□ D-B64 D-B59W		D-G39 D-K39 D-A3□		D-A44		D-F5□ D-J59 D-F5□W D-J59W D-F5BA D-F59F D-F5NT		D-A5□ D-A6□ D-A59W		D-G39C D-K39C D-A3□C		D-A44C		
	Hs	Ht	Hs	Ht	Hs	Ht	Hs	Ht	Hs	Ht	Hs	Ht	Hs	Ht	Hs	Ht	Hs	Ht	Hs	Ht	Hs	Ht	Hs	Ht	Hs	Ht	Hs	Ht	Hs
40	30	30	34	30	31	30	30	30	30	30	37.5	35	42.5	33	37	71.5	81.5	38	31.5	38.5	31.5	73	69	81	69				
50	34	34	38	34	35	34	34	34	34	41.5	39	46.5	37.5	42	76.5	86.5	42	35.5	42	35.5	78.5	77	86.5	77					
63	41	41	44	41	41.5	41	41	41	41	50	41	52	43	49	83.5	93.5	47	43	46.5	43	85.5	91	93.5	91					
80	49.5	49	52.5	49	50	49	49.5	49	49.5	49	58	49	58.5	51.5	57.5	92	102	53.5	51	53.5	51	94	107	102	107				
100	56.5	56	61	56	58.5	56	56.5	55.5	57.5	55.5	66	56	66	58.5	68	102.5	112.5	61	57.5	61.5	57.5	104	121	112	121				

Auto Switch Proper Mounting Position (Detection at stroke end) and Its Mounting Height

Auto Switch Proper Mounting Position (Non-rotating rod type, With end lock)

(mm)

Auto switch model	D-M9□ D-M9□V D-M9□W D-M9□WV D-M9□A D-M9□AV		D-A9□ D-A9□V		D-Y59□ D-Y69□ D-Y7P D-Y7PV D-Y7□W D-Y7□WV D-Y7BA D-B59W D-Z7□ D-Z80		D-P3DWA		D-P4DW		D-G39 D-G39C D-K39 D-K39C D-A5□ D-A6□ D-A3□ D-A3□C D-A44 D-A44C		D-G5□ D-K59 D-G5NT D-G5□W D-K59W D-G5BA D-G59F		D-B5□ D-B64		D-F5□ D-J59 D-F59F D-F5□W D-J59W D-F5BA		D-F5NT		D-A59W	
	A	B	A	B	A	B	A	B	A	B	A	B	A	B	A	B	A	B	A	B	A	B
40	10	8	6	4	4	1	5.5	3.5	3.5	0.5	0.5	0	2.5	0	1	0	7	4	12	9	4.5	1.5
50	10	8	6	4	3.5	1.5	5.3	3.5	3	1	0	0	2	0	0.5	0	6.5	4.5	11.5	9.5	4	2
63	12.5	11.5	8.5	7.5	6	5	8	7	5.5	4.5	2.5	1.5	4.5	3.5	3	2	9	8	14	13	6.5	5.5
80	16	14	12	10	9.5	7.5	11.5	9.5	9	7	6	4	8	6	6.5	4.5	12.5	10.5	17.5	15.5	10	8
100	17.5	16.5	13.5	12.5	11	10	13	12	10.5	9.5	7.5	6.5	9.5	8.5	8	7	14	13	19	18	11.5	10.5

Note) Adjust the auto switch after confirming the operating conditions in the actual setting.

Auto Switch Proper Mounting Height (Non-rotating rod type, With end lock)

(mm)

Auto switch model	D-M9□ D-M9□W D-M9□A D-A9□		D-M9□V D-M9□WV D-M9□AV		D-A9□V		D-Y59□ D-Y7P D-Y7□W D-Y7BA D-Z7□ D-Z80		D-Y69□ D-Y7PV D-Y7□WV		D-P3DWA		D-P4DW		D-G5□ D-K59 D-G5□W D-K59W D-G59F D-G5BA D-G5NT D-B5□ D-B64 D-B59W		D-G39 D-K39 D-A3□		D-A44		D-F5□ D-J59 D-F5□W D-F59F D-F5BA D-F5NT		D-A5□ D-A6□		D-G39C D-K39C D-A3□C		D-A44C		
	Hs	Ht	Hs	Ht	Hs	Ht	Hs	Ht	Hs	Ht	Hs	Ht	Hs	Ht	Hs	Ht	Hs	Ht	Hs	Ht	Hs	Ht	Hs	Ht	Hs	Ht	Hs	Ht	Hs
40	30	30	34	30	31	30	30	30	30	30	37.5	35	42.5	33	37	71.5	81.5	38	31.5	38.5	31.5	73	69	81	69				
50	34	34	38	34	35	34	34	34	34	34	41.5	39	46.5	37.5	42	76.5	86.5	42	35.5	42	35.5	78.5	77	86.5	77				
63	41	41	44	41	41.5	41	41	41	41	41	50	41	52	43	49	83.5	93	47	43	46.5	43	85.5	91	93.5	91				
80	49.5	49	52.5	49	50	49	49.5	49	49.5	49	58	49	58.5	51.5	57.5	92	102	53.5	51	53.5	51	94	107	102	107				
100	56.5	56	61	56	58.5	56	58.5	55.5	57.5	55.5	66	56	66	58.5	68	102.5	112.5	61	57.5	61.5	57.5	104	121	112	121				

Auto Switch Proper Mounting Position (Detection at stroke end) and Its Mounting Height

Auto Switch Proper Mounting Position (Air-hydro type)

(mm)

Auto switch model	D-M9□ D-M9□V D-M9□W D-M9□WV D-M9□A D-M9□AV		D-A9□ D-A9□V		D-Y59□ D-Y69□ D-Y7P D-Y7PV D-Y7□W D-Y7□WV D-Y7BA D-B59W D-Z7□ D-Z80		D-P3DWA		D-P4DW		D-G39 D-G39C D-K39 D-K39C D-A5□ D-A6□ D-A3□ D-A3□C D-A44 D-A44C		D-G5□ D-K59 D-G5NT D-G5□W D-K59W D-G5BA D-G59F		D-B5□ D-B64		D-F5□ D-J59 D-F59F D-F5□W D-J59W D-F5BA		D-F5NT		D-A59W		
	A	B	A	B	A	B	A	B	A	B	A	B	A	B	A	B	A	B	A	B	A	B	A
40	10	8	6	4	4	1	5.5	3.5	3	1	0	0	2	0	0.5	0	6.5	4.5	11.5	9.5	4	2	
50	10	8	—	—	3.5	1.5	5.5	3.5	3	1	0	0	2	0	0.5	0	6.5	4.5	11.5	9.5	4	2	
63	12.5	11.5	—	—	6	5	8	7	5.5	4.5	2.5	1.5	4.5	3.5	3	2	9	8	14	13	6.5	5.5	
80	16	14	12	10	9.5	7.5	11.5	9.5	9	7	6	4	8	6	6.5	4.5	12.5	10.5	17.5	15.5	10	8	
100	17.5	16.5	13.5	12.5	11	10	13	12	10.5	9.5	7.5	6.5	9.5	8.5	8	7	14	13	19	18	11.5	10.5	

* D-A9□ and D-A9□V types cannot be mounted on ø50.

Note) Adjust the auto switch after confirming the operating conditions in the actual setting.

Auto Switch Proper Mounting Height (Air-hydro type)

(mm)

Auto switch model	D-M9□ D-M9□V D-M9□A D-A9□		D-M9□V D-M9□W D-M9□AV		D-A9□V		D-Y59□ D-Y7P D-Y7BA D-Y7□W D-Z7□ D-Z80		D-Y69□ D-Y7PV D-Y7□WV		D-P3DWA		D-P4DW		D-G5□ D-K59 D-G5NT D-G5□W D-K59W D-G5BA D-G59F D-B5□ D-B64 D-B59W		D-G39 D-K39 D-A3□		D-A44		D-F5□ D-J59 D-F5□W D-J59W D-F59F D-F5NT		D-A5□ D-A6□ D-A59W		D-G39C D-K39C D-A3□C		D-A44C		
	Hs	Ht	Hs	Ht	Hs	Ht	Hs	Ht	Hs	Ht	Hs	Ht	Hs	Ht	Hs	Ht	Hs	Ht	Hs	Ht	Hs	Ht	Hs	Ht	Hs	Ht	Hs	Ht	Hs
40	30	30	35	30	32	30	30	30	30	30	38	36	43	33.5	38	38	72.5	82.5	38.5	31	40	31	73	69	81	69			
50	34	34	39	34	—	—	34	34	35	34	42	40.5	47	38	43.5	78	88	42.5	35	43.5	35	78.5	77	86.5	77				
63	41	41	46	41	43.5	41	41	41	42.5	41	51	41	53	44	51	85.5	95.5	48	42	49	42	85.5	91	93.5	91				
80	49.5	49	54	49	51.5	49	49.5	48.5	51	48.5	59	49	60	52	59	93.5	103.5	54	50	55.5	50	94	107	102	107				
100	57	56	62.5	56	59.5	56	58.5	56	59	56	67	56	67	59	69.5	104	114	62	57.5	63	57.5	104	121	112	121				

* D-A9□ and D-A9□V types cannot be mounted on ø50.

Operating Range

(mm)

Auto switch model	Bore size				
	40	50	63	80	100
D-M9□/M9□V D-M9□W/M9□WV D-M9□A/M9□AV	4.5	5	5.5	5	6
D-A9□/A9□V	7.5 (7)	8.5 (—)	9.5 (9)	9.5 (9)	10.5 (9)
D-Z7□/Z80	8.5	7.5	9.5	9.5	10.5
D-A3□/A44 D-A3□C/A44C	9	10	11	11	11
D-A5□/A6□					
D-B5□/B64					
D-A59W	13	13	14	14	15
D-B59W	14	14	17	16	18

Auto switch model	Bore size				
	40	50	63	80	100
D-Y59□/Y69□ D-Y7P/Y7□V D-Y7□W/Y7□WV D-Y7BA	8	7	5.5	6.5	6.5
D-F5□/J59/F5□W D-J59W/F5BA D-F5NT/F59F	4	4	4.5	4.5	4.5
D-G5□/K59/G5□W D-K59W/G5BA D-G5NT/G59F	5	6	6.5	6.5	7
D-G39/K39 D-G39C/K39C	9	9	10	10	11
D-P3DWA	4.5	4.5	5.5	5.5	5.5
D-P4DW	4	4	4.5	4	4.5

* Values which include hysteresis are for guideline purposes only, they are not a guarantee (assuming approximately ±30% dispersion) and may change substantially depending on the ambient environment.

Note 1) (): For CDA2□H and CDA2W□H Series.

Note 2) D-A9□ and D-A9□V types cannot be mounted on ø50 of the CDA2□H and CDA2W□H series.

Minimum Stroke for Auto Switch Mounting

Auto switch model	Number of auto switches	Brackets other than center trunnion	Center trunnion				
			n: Number of auto switches (mm)				
			ø40	ø50	ø63	ø80	ø100
D-M9□ D-M9□W	2 (Different surfaces and same surface) 1	15	80		85	90	95
	n	$15 + 40 \frac{(n-2)}{2}$ (n = 2, 4, 6, 8... Note 1)	$80 + 40 \frac{(n-4)}{2}$ (n = 4, 8, 12, 16... Note 2)		$85 + 40 \frac{(n-4)}{2}$ (n = 4, 8, 12, 16... Note 2)	$90 + 40 \frac{(n-4)}{2}$ (n = 4, 8, 12, 16... Note 2)	$95 + 40 \frac{(n-4)}{2}$ (n = 4, 8, 12, 16... Note 2)
D-M9□V D-M9□WV	2 (Different surfaces and same surface) 1	10	55		60	65	70
	n	$10 + 30 \frac{(n-2)}{2}$ (n = 2, 4, 6, 8... Note 1)	$55 + 30 \frac{(n-4)}{2}$ (n = 4, 8, 12, 16... Note 2)		$60 + 30 \frac{(n-4)}{2}$ (n = 4, 8, 12, 16... Note 2)	$65 + 30 \frac{(n-4)}{2}$ (n = 4, 8, 12, 16... Note 2)	$70 + 30 \frac{(n-4)}{2}$ (n = 4, 8, 12, 16... Note 2)
D-M9□A	2 (Different surfaces and same surface) 1	15	80		85	95	100
	n	$15 + 40 \frac{(n-2)}{2}$ (n = 2, 4, 6, 8... Note 1)	$80 + 40 \frac{(n-4)}{2}$ (n = 4, 8, 12, 16... Note 2)		$85 + 40 \frac{(n-4)}{2}$ (n = 4, 8, 12, 16... Note 2)	$95 + 40 \frac{(n-4)}{2}$ (n = 4, 8, 12, 16... Note 2)	$100 + 40 \frac{(n-4)}{2}$ (n = 4, 8, 12, 16... Note 2)
D-M9□AV	2 (Different surfaces and same surface) 1	10	60		65	70	75
	n	$10 + 30 \frac{(n-2)}{2}$ (n = 2, 4, 6, 8... Note 1)	$60 + 30 \frac{(n-4)}{2}$ (n = 4, 8, 12, 16... Note 2)		$65 + 30 \frac{(n-4)}{2}$ (n = 4, 8, 12, 16... Note 2)	$70 + 30 \frac{(n-4)}{2}$ (n = 4, 8, 12, 16... Note 2)	$75 + 30 \frac{(n-4)}{2}$ (n = 4, 8, 12, 16... Note 2)
D-A9□	2 (Different surfaces and same surface) 1	15	75		80	85	90
	n	$15 + 40 \frac{(n-2)}{2}$ (n = 2, 4, 6, 8... Note 1)	$75 + 40 \frac{(n-4)}{2}$ (n = 4, 8, 12, 16... Note 2)		$80 + 40 \frac{(n-4)}{2}$ (n = 4, 8, 12, 16... Note 2)	$85 + 40 \frac{(n-4)}{2}$ (n = 4, 8, 12, 16... Note 2)	$90 + 40 \frac{(n-4)}{2}$ (n = 4, 8, 12, 16... Note 2)
D-A9□V	2 (Different surfaces and same surface) 1	10	50		55	60	65
	n	$10 + 30 \frac{(n-2)}{2}$ (n = 2, 4, 6, 8... Note 1)	$50 + 30 \frac{(n-4)}{2}$ (n = 4, 8, 12, 16... Note 2)		$55 + 30 \frac{(n-4)}{2}$ (n = 4, 8, 12, 16... Note 2)	$60 + 30 \frac{(n-4)}{2}$ (n = 4, 8, 12, 16... Note 2)	$65 + 30 \frac{(n-4)}{2}$ (n = 4, 8, 12, 16... Note 2)
D-F5□/J59 D-F5□W/J59W D-F5BA/F59F D-A5□/A6	2 (Different surfaces and same surface) 1	15	90		100	110	120
	n (Same surface)	$15 + 55 \frac{(n-2)}{2}$ (n = 2, 4, 6, 8... Note 1)	$90 + 55 \frac{(n-4)}{2}$ (n = 4, 8, 12, 16... Note 2)		$100 + 55 \frac{(n-4)}{2}$ (n = 4, 8, 12, 16... Note 2)	$110 + 55 \frac{(n-4)}{2}$ (n = 4, 8, 12, 16... Note 2)	$120 + 55 \frac{(n-4)}{2}$ (n = 4, 8, 12, 16... Note 2)
D-F5NT	2 (Different surfaces and same surface) 1	25	110		120	130	140
	n (Same surface)	$25 + 55 \frac{(n-2)}{2}$ (n = 2, 4, 6, 8... Note 1)	$110 + 55 \frac{(n-4)}{2}$ (n = 4, 8, 12, 16... Note 2)		$120 + 55 \frac{(n-4)}{2}$ (n = 4, 8, 12, 16... Note 2)	$130 + 55 \frac{(n-4)}{2}$ (n = 4, 8, 12, 16... Note 2)	$140 + 55 \frac{(n-4)}{2}$ (n = 4, 8, 12, 16... Note 2)
D-A59W	2 (Different surfaces and same surface) 1	20	90		100	110	120
	n (Same surface)	$20 + 55 \frac{(n-2)}{2}$ (n = 2, 4, 6, 8... Note 1)	$90 + 55 \frac{(n-4)}{2}$ (n = 4, 8, 12, 16... Note 2)		$100 + 55 \frac{(n-4)}{2}$ (n = 4, 8, 12, 16... Note 2)	$110 + 55 \frac{(n-4)}{2}$ (n = 4, 8, 12, 16... Note 2)	$120 + 55 \frac{(n-4)}{2}$ (n = 4, 8, 12, 16... Note 2)
	1	15	90		100	110	120
D-G5□/K59 D-G5□W D-K59W D-G5BA D-G59F D-G5NT D-B5□/B64	2 Different surfaces	15	90	100	110		
	Same surface	75					
	n	Different surfaces	$15 + 50 \frac{(n-2)}{2}$ (n = 2, 4, 6, 8... Note 1)	$90 + 50 \frac{(n-4)}{2}$ (n = 4, 8, 12, 16... Note 2)	$100 + 50 \frac{(n-4)}{2}$ (n = 4, 8, 12, 16... Note 2)	$110 + 50 \frac{(n-4)}{2}$ (n = 4, 8, 12, 16... Note 2)	
		Same surface	$75 + 50 (n-2)$ (n = 2, 3, 4...)	$90 + 50 (n-2)$ (n = 2, 4, 6, 8... Note 1)	$100 + 50 (n-2)$ (n = 2, 4, 6, 8... Note 1)	$110 + 50 (n-2)$ (n = 2, 4, 6, 8... Note 1)	
			1	10	90	100	110
D-B59W	2 Different surfaces	20	90	100	110		
	Same surface	75					
	n	Different surfaces	$20 + 50 \frac{(n-2)}{2}$ (n = 2, 4, 6, 8... Note 1)	$90 + 50 \frac{(n-4)}{2}$ (n = 4, 8, 12, 16... Note 2)	$100 + 50 \frac{(n-4)}{2}$ (n = 4, 8, 12, 16... Note 2)	$110 + 50 \frac{(n-4)}{2}$ (n = 4, 8, 12, 16... Note 2)	
		Same surface	$75 + 50 (n-2)$ (n = 2, 3, 4...)	$90 + 50 (n-2)$ (n = 2, 4, 6, 8... Note 1)	$100 + 50 (n-2)$ (n = 2, 4, 6, 8... Note 1)	$110 + 50 (n-2)$ (n = 2, 4, 6, 8... Note 1)	
1	15	90	100	110			

Note 1) When "n" is an odd number, an even number that is one larger than this odd number is used for the calculation.
 Note 2) When "n" is an odd number, a multiple of 4 that is larger than this odd number is used for the calculation.

Minimum Stroke for Auto Switch Mounting

			n: Number of auto switches (mm)				
Auto switch model	Number of auto switches	Brackets other than center trunnion	Center trunnion				
			ø40	ø50	ø63	ø80	ø100
D-G39 D-K39 D-A3□	2	Different surfaces	35	75	80	90	
		Same surface	100	100	100	100	
	n	Different surfaces	$35 + 30(n-2)$ (n = 2, 3, 4...)	$75 + 30(n-2)$ (n = 2, 4, 6, 8...) ^{Note 1}	$80 + 30(n-2)$ (n = 2, 4, 6, 8...) ^{Note 1}	$90 + 30(n-2)$ (n = 2, 4, 6, 8...) ^{Note 1}	
		Same surface	$100 + 100(n-2)$ (n = 2, 3, 4...)		$100 + 100(n-2)$ (n = 2, 4, 6, 8...) ^{Note 1}		
	1	10	75	80	90		
D-A44	2	Different surfaces	35	75	80	90	
		Same surface	55				
	n	Different surfaces	$35 + 30(n-2)$ (n = 2, 3, 4...)	$75 + 30(n-2)$ (n = 2, 4, 6, 8...) ^{Note 1}	$80 + 30(n-2)$ (n = 2, 4, 6, 8...) ^{Note 1}	$90 + 30(n-2)$ (n = 2, 4, 6, 8...) ^{Note 1}	
		Same surface	$55 + 50(n-2)$ (n = 2, 3, 4...)	$75 + 50(n-2)$ (n = 2, 4, 6, 8...) ^{Note 1}	$80 + 50(n-2)$ (n = 2, 4, 6, 8...) ^{Note 1}	$90 + 50(n-2)$ (n = 2, 4, 6, 8...) ^{Note 1}	
	1	10	75	80	90		
D-G39C D-K39C D-A3□C	2	Different surfaces	20	75	80	90	
		Same surface	100	100	100	100	
	n	Different surfaces	$20 + 35(n-2)$ (n = 2, 3, 4...)	$75 + 35(n-2)$ (n = 2, 4, 6, 8...) ^{Note 1}	$80 + 35(n-2)$ (n = 2, 4, 6, 8...) ^{Note 1}	$90 + 35(n-2)$ (n = 2, 4, 6, 8...) ^{Note 1}	
		Same surface	$100 + 100(n-2)$ (n = 2, 3, 4, 5...)		$100 + 100(n-2)$ (n = 2, 4, 6, 8...) ^{Note 1}		
	1	10	75	80	90		
D-A44C	2	Different surfaces	20	75	80	90	
		Same surface	55	75	80	90	
	n	Different surfaces	$20 + 35(n-2)$ (n = 2, 3, 4...)	$75 + 35(n-2)$ (n = 2, 4, 6, 8...) ^{Note 1}	$80 + 35(n-2)$ (n = 2, 4, 6, 8...) ^{Note 1}	$90 + 35(n-2)$ (n = 2, 4, 6, 8...) ^{Note 1}	
		Same surface	$55 + 50(n-2)$ (n = 2, 3, 4...)	$75 + 50(n-2)$ (n = 2, 4, 6, 8...) ^{Note 1}	$80 + 50(n-2)$ (n = 2, 4, 6, 8...) ^{Note 1}	$90 + 50(n-2)$ (n = 2, 4, 6, 8...) ^{Note 1}	
	1	10	75	80	90		
D-Y59□/Y7P D-Y7□W D-Z7□/Z80	2 (Different surfaces and same surface) 1	15	80	85	90	95	105
	n	$15 + 40 \frac{(n-2)}{2}$ (n = 2, 4, 6, 8...) ^{Note 1}	$80 + 40 \frac{(n-4)}{2}$ (n = 4, 8, 12, 16...) ^{Note 2}	$85 + 40 \frac{(n-4)}{2}$ (n = 4, 8, 12, 16...) ^{Note 2}	$90 + 40 \frac{(n-4)}{2}$ (n = 4, 8, 12, 16...) ^{Note 2}	$95 + 40 \frac{(n-4)}{2}$ (n = 4, 8, 12, 16...) ^{Note 2}	$105 + 40 \frac{(n-4)}{2}$ (n = 4, 8, 12, 16...) ^{Note 2}
D-Y69□/Y7PV D-Y7□WV	2 (Different surfaces and same surface) 1	10	65	75	80	90	
	n	$10 + 30 \frac{(n-2)}{2}$ (n = 2, 4, 6, 8...) ^{Note 1}	$65 + 30 \frac{(n-4)}{2}$ (n = 4, 8, 12, 16...) ^{Note 2}	$75 + 30 \frac{(n-4)}{2}$ (n = 4, 8, 12, 16...) ^{Note 2}	$80 + 30 \frac{(n-4)}{2}$ (n = 4, 8, 12, 16...) ^{Note 2}	$90 + 30 \frac{(n-4)}{2}$ (n = 4, 8, 12, 16...) ^{Note 2}	
D-Y7BA	2 (Different surfaces and same surface) 1	20	95	100	105	110	
	n	$20 + 45 \frac{(n-2)}{2}$ (n = 2, 4, 6, 8...) ^{Note 1}	$95 + 45 \frac{(n-4)}{2}$ (n = 4, 8, 12, 16...) ^{Note 2}	$100 + 45 \frac{(n-4)}{2}$ (n = 4, 8, 12, 16...) ^{Note 2}	$105 + 45 \frac{(n-4)}{2}$ (n = 4, 8, 12, 16...) ^{Note 2}	$110 + 45 \frac{(n-4)}{2}$ (n = 4, 8, 12, 16...) ^{Note 2}	
D-P3DWA	2 (Different surfaces and same surface) 1	15		85			
	n	$15 + 50 \frac{(n-2)}{2}$ (n = 2, 4, 6, 8...) ^{Note 1}		$85 + 50 \frac{(n-4)}{2}$ (n = 4, 8, 12, 16...) ^{Note 2}			
D-P4DW	2 (Different surfaces and same surface) 1	15	120	130	140		
	n	$15 + 65 \frac{(n-2)}{2}$ (n = 2, 4, 6, 8...) ^{Note 1}	$120 + 65 \frac{(n-4)}{2}$ (n = 4, 8, 12, 16...) ^{Note 2}	$130 + 65 \frac{(n-4)}{2}$ (n = 4, 8, 12, 16...) ^{Note 2}	$140 + 65 \frac{(n-4)}{2}$ (n = 4, 8, 12, 16...) ^{Note 2}		

Note 1) When "n" is an odd number, an even number that is one larger than this odd number is used for the calculation.

Note 2) When "n" is an odd number, a multiple of 4 that is larger than this odd number is used for the calculation.

Auto Switch Mounting Brackets/Part No.

<Tie-rod mounting>

Auto switch model	Bore size (mm)				
	40	50	63	80	100
D-M9□/M9□V D-M9□W/M9□WV D-M9□A/M9□AV D-A9□/A9□V	BA7-040	BA7-040	BA7-063	BA7-080	BA7-080
D-F5□/J59 D-F5□W/J59W D-F59F/F5NT D-A5□/A6□ D-A59W	BT-04	BT-04	BT-06	BT-08	BT-08
D-G39C/K39C D-A3□C/A44C	BA3-040	BA3-050	BA3-063	BA3-080	BA3-100
D-Y59□/Y69□ D-Y7P/Y7PV D-Y7□W/Y7□WV D-Y7BA D-Z7□/Z80	BA4-040	BA4-040	BA4-063	BA4-080	BA4-080
D-P3DWA	BK7-040S	BK7-040S	BA10-063S	BA10-080S	BA10-080S
D-P4DW	BAP2-040	BAP2-040	BAP2-063	BAP2-080	BAP2-080

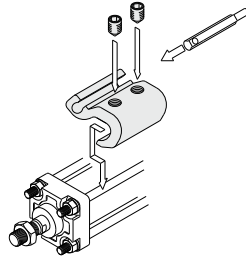

* The figure shows the mounting example for the D-M9□(V)/M9□W(V)/M9□A(V)/A9□(V) types.

<Band mounting>

Except air-hydro type

Auto switch model	Bore size (mm)				
	40	50	63	80	100
D-G39/K39 D-A3□/A44	BDS-04M	BDS-05M	BMB1-063	BMB1-080	BMB1-100
D-G5□/K59 D-G5□W/K59W D-G59F D-G5NT D-B5□/B64 D-B59W	BH2-040	BA5-050	BAF-06	BAF-08	BAF-10

Note 1) Auto switch brackets are included in the D-A3□C/A44C/G39C/K39C types. Specify the part number as follows depending on the cylinder size when ordering.
(Example) ø40: D-A3□C-4, ø50: D-A3□C-5, ø63: D-A3□C-6, ø80: D-A3□C-8, ø100: D-A3□C-10

[Stainless Steel Mounting Screw]

The following stainless steel mounting screw kit (including set screws) is also available. Use it in accordance with the operating environment.
(Since the auto switch mounting bracket and band are not included, order them separately.)

- BBA1: For D-A5/A6/F5/J5 types
- BBA3: For D-B5/B6/G5/K5 types

Note 2) Refer to pages 1369 and 1377 for details on the BBA1 and BBA3.

The above stainless steel screws are used when a cylinder is shipped with D-F5BA or G5BA auto switches. When only an auto switch is shipped independently, the BBA1 or BBA3 is attached.

Note 3) When using the D-M9□(A)V or Y7BA, do not use the steel set screws which are included with the above auto switch mounting brackets (BA7-□□□, BA4-□□□). Order a stainless steel screw kit (BBA1) separately, and use the M4 x 6 L stainless steel set screws included in the BBA1.

Note 4) There is a difference in the cylinder tube thickness depending on the cylinder model. Use caution when a band mounting type is used as an applicable auto switch and a cylinder model is changed.

Air-hydro type

Auto switch model	Bore size (mm)				
	40	50	63	80	100
D-G39/K39 D-A3□/A44	BD1-04M	BD1-05M	BD1-06M	BD1-08M	BD1-10M
D-G5□/K59 D-G5□W/K59W D-G59F D-G5NT D-B5□/B64 D-B59W	BA-04	BA-05	BA-06	BA-08	BA-10

Other than the applicable auto switches listed in "How to Order", the following auto switches are mountable.

Refer to pages 1271 to 1365 for the detailed specifications.

Type	Model	Electrical entry	Features	
Solid state	D-M9NV/M9PV/M9BV D-Y69A/Y69B/Y7PV D-M9NWV/M9PWV/M9BWW D-Y7NWV/Y7PWV/Y7BWW D-M9NAV/M9PAV/M9BAV	Grommet (Perpendicular)	—	
	D-Y59A/Y59B/Y7P D-F59/F5P/J59 D-Y7NW/Y7PW/Y7BW		Diagnostic indication (2-color indicator)	
	D-F59W/F5PW/J59W D-F5BA/Y7BA D-F5NT/G5NT		Grommet (In-line)	Water resistant (2-color indicator)
	D-P5DW		With timer	
	D-A93V/A96V D-A90V		Grommet (Perpendicular)	Magnetic field resistant (2-color indicator)
	D-A53/A56/B53/Z73/Z76 D-A67/Z80	Grommet (In-line)	Without indicator light	

* With pre-wired connector is also available for solid state auto switches. For details, refer to pages 1340 and 1341.

* Normally closed (NC = b contact) solid state auto switches (D-M9□E(V)/Y7G/Y7H) are also available. For details, refer to pages 1290 and 1292.

1 Cylinder with Heat Resistant Reed Auto Switch (-10 to 120°C)

Symbol
-X1184

Applicable Series

Description	Model	Action	Note
Standard type	CA2	Double acting, Single rod	

How to Order

CDA2 Standard model no. Z - Heat resistant reed auto switch - X1184

Switch model	
Symbol	Description
Nii	Without switch
B30	D-B30
B30J	D-B30J
B31	D-B31
B31J	D-B31J
B35	D-B35
B35J	D-B35J

Number of switches	
Symbol	Description
S	1 pc.
Nii	2 pcs.

Cylinder with heat resistant reed auto switch

* For details about auto switches, refer to pages 1363 to 1365.

Specifications

Ambient temperature range	-10°C to 120°C
Seal material	Fluororubber
Grease	Heat resistant grease

Warning Precautions

Be aware that smoking cigarettes etc. after your hands have come into contact with the grease used in this cylinder can create a gas that is hazardous to humans.

Dimensions (Dimensions other than below are the same as standard type.)

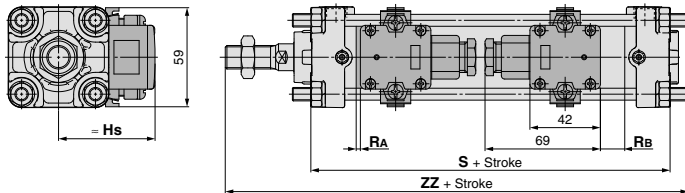

(mm)

Bore size	Hs	RA	RB	S	ZZ	Minimum mounting stroke		Auto switch mounting bracket part number
						Other than center trunnion	Center trunnion	
40	57.5	4	13	99	161	1 pc.: 50 st or more	180 st or more	BD1-04M
50	62.5	4	13	105	174		180 st or more	BD1-05M
63	69	7	16	113	185	2 pcs.: Different surfaces 50 st or more	190 st or more	BD1-06M
80	78	5.5	23.5	131	219		200 st or more	BD1-08M
100	88.5	7.5	25.5	141	230	2 pcs.: Same surface 220 st or more	210 st or more	BD1-10M



CA2 Series Specific Product Precautions

Be sure to read this before handling the products. Refer to page 20 for safety instructions and pages 21 to 30 for actuator and auto switch precautions.

Handling

⚠ Caution

1. **Do not open the cushion valve beyond the stopper.**
A retaining ring is installed as a cushion valve retention mechanism. Do not open the cushion valve beyond it. If not operated in accordance with the above precautions, the cushion valve may be ejected from the cover when air pressure is supplied.

Bore size (mm)	Width across flats	Socket wrench
40, 50	2.5	JIS 4648 Hexagonal wrench key 2.5
63, 80, 100	4	JIS 4648 Hexagonal wrench key 4

2. **Use the air cushion at the end of cylinder stroke.**
Otherwise, the tie-rod or piston rod assembly will be damaged.

⚠ Caution

1. **Do not use a pneumatic type as an air-hydro cylinder. It can cause oil leak.**
2. **Do not rotate the piston rod when the rod boot is fixed.**
Before rotating the piston rod, loosen the band to avoid twisting the rod boot.
3. **Install the rod boot with the breathing hole facing downwards or in a direction suitable to prevent dust, moisture etc. from entering easily into the rod boot.**

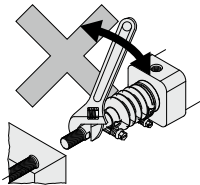

Disassembly/Replacement

⚠ Caution

1. **Use a socket wrench when the bracket is replaced.**
If other tools are used, the nut or other parts may be deformed or the work efficiency may decrease.
For applicable sockets, refer to the table below.

Bore size (mm)	Nut	Width across flats	Socket	Tightening torque (N·m)
40, 50	DA00040	13	JIS B4636	7.4
	(M8 x 1.25, Hexagon nut 3 types)		+ Two-angle socket 13	
63	DA00010	17	JIS B4636	20
	(M10 x 1.25, Hexagon nut 3 types)		+ Two-angle socket 17	
80, 100	DA00131	19	JIS B4636	29
	(M12 x 1.75, Hexagon nut 3 types)		+ Two-angle socket 19	

2. **Do not replace the bushing.**
As the bushing is press-fit, it cannot be replaced individually.
3. **When a seal is replaced, apply grease to the new seal before it is assembled.**
Operation of the cylinder without greasing will result in extreme abrasion of the seal, causing premature air leakage.
4. **Do not disassemble the trunnion type cylinder because the mounting precision is required.**
It is difficult to align the axial center of the trunnion with the axial center of the cylinder. Thus, if this type of cylinder is disassembled and reassembled, the required dimensional accuracy cannot be attained, which may lead to malfunctions.

Water Resistant Air Cylinder

Water resistant air cylinders are also available in CA2 series, which are suitable for use on machine tools, where exposure to coolant is possible and applicable for food machinery and automobile washing equipment in an environment where water splashes. Please contact SMC for more information.