

Power Valve Precision Regulator **VEX1□3⁰₃ Series**

High precision, large capacity relief regulator

A 3 port large exhaust capacity pressure reducing valve which utilizes a nozzle flapper mechanism available as air operated or manual types.

Precise pressure setting

Having a relief Cv value that is similar to the supply Cv value, this regulator responds quickly in order to set a precise outlet pressure even when the outlet volume and the pressure fluctuations are large.

High precision

This regulator is well-suited for balancer applications because it minimizes pressure fluctuations with its large-volume supply/exhaust capability, in addition it features high precision F.S. (full span) sensitivity within 0.2% and F.S. repeatability of $\pm 0.5\%$.

Manifold capable

VVEXB 1/8—Up to 10 stations
VVEX2 1/4—Up to 8 stations

Rich line-up

Port sizes available from M5 to 2 inches, most flow rates and pipes can be accommodated.

Minimum size VEX1^A_B 33

- Non-grease only for VEX1^A_B 33
- Seal materials (NBR, FKM) only for VEX1^A_B 33



Manual knob type

Air operated type

Application Example

Relief Type Regulator

Precise internal tank pressure setting

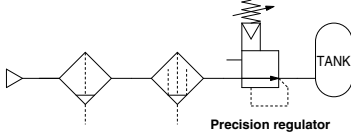

- Large effective areas of both supply and exhaust sides make it possible to precisely set large-flow internal tank pressure.

Accurate Pressure Setting

Sensitivity within 0.2% F.S. (Full span) Tension control

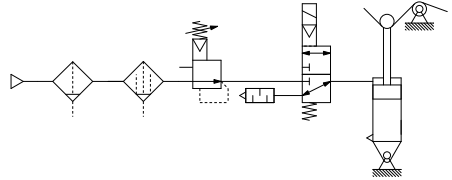

Contact Pressure Control

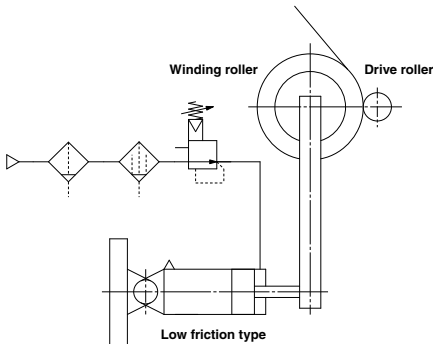

- Pressure is kept steady, responding rapidly to the position change of the piston in the cylinder.

Balance and Drive

Accurate balance pressure setting

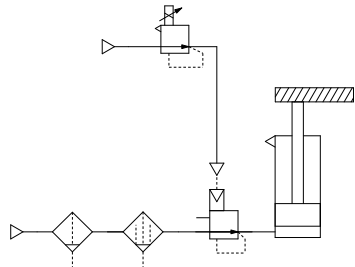

- Pressure changes during cylinder actuation are suppressed, balancing the cylinder in both static and dynamic conditions.

ARJ

AR425
to 935

ARX

AMR

ARM

ARP

IR□-A

IR

IRV

VEX

SRH

SRP

SRF

ITV

IC

ITVH

ITVX

PVQ

VY1

VBA

VBAT

AP100

VEX1□3⁰ Series

Specifications

Model	VEX1A33		VEX1B33		VEX113 ⁰ ₃		VEX123 ⁰ ₃		VEX133 ⁰ ₃			VEX153 ⁰ ₃			VEX173 ⁰ ₃			VEX193 ⁰ ₃	
Port size	Port	M5	01	M5	01	01	02	01	02	02	03	04	04	06	10	10	12	14	20
	1(P)	M5	1/8	M5	1/8	1/8	1/4	1/8	1/4	1/4	3/8	1/2	1/2	3/4	1	1	1 1/4	1 1/2	2
	2(A)																		
3(R)																			
Operation	Manual knob (Push locking slotted type)				Manual knob (Push locking slotted type) and Air operated type														
Pilot	Internal pilot (External pilot can be switched. * Refer to "How to Switch to External Pilot" on page 843.)																		
Fluid	Refer to Applicable Fluids.				Air														
Supply pressure	(Set pressure + 0.1 MPa) to Max. 1 MPa * Refer to "Precautions".																		
Setting pressure range	0.01 to 0.7 MPa				0.05 to 0.7 MPa														
Ambient temperature ⁽¹⁾	0 to 60°C																		
Fluid temperature ⁽¹⁾	0 to 60°C (VEX1 ⁰ ₃₃) 0 to 99°C (VEX1 ⁰ _{33B})				0 to 60°C														
Repeatability	Within ±0.5% F.S. (Full span)																		
Sensitivity	Within 0.2% F.S. (Full span)																		
Linearity ⁽³⁾	—				Within ±1% F.S. (Full span)														
Air consumption ⁽²⁾	9.5 L/min (ANR) (at supply pressure 1.0 MPa)																		
Mounting	Free																		
Weight (kg)	0.15		0.18 ⁽⁴⁾		0.2		0.3 ⁽⁴⁾		0.5			1.4			2			4	

Note 1) No condensation.
 Note 2) Large amount of air is exhausted all the time.
 Note 3) Applicable only to air operated type.
 Note 4) With sub-plate.
 Note 5) Non-lubricated specifications are not available for valve sizes 1 to 9.



Applicable Fluids

Model	VEX1 ⁰ ₃₃ (Seal material: NBR seals)	VEX1 ⁰ _{33B} (Seal material: FKM seals)
Fluid	Air (Normal, Dry)	High temp. air (Max. 99°C)

Symbol

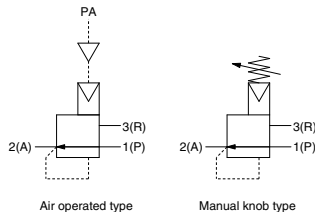

How to Order

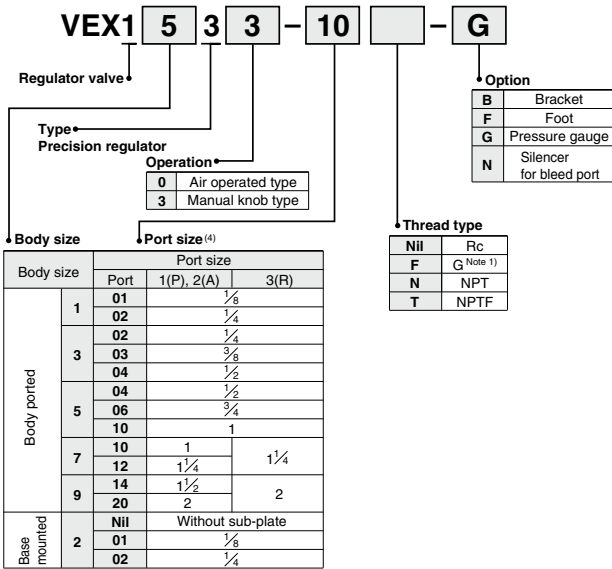
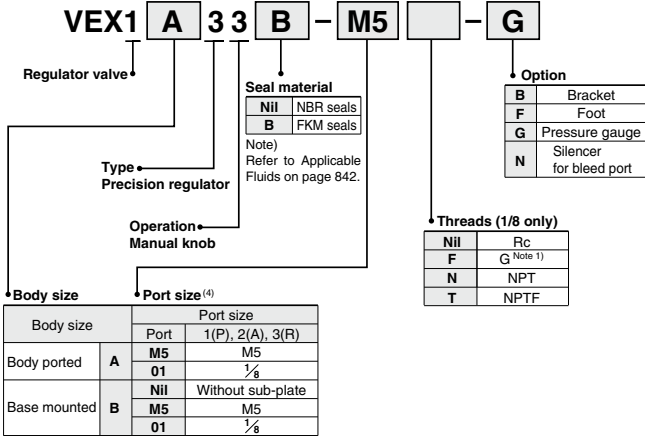

Option (2)

Description		Part no.							
		VEX1A33	VEX1B33	VEX113 ³	VEX123 ³	VEX133 ³	VEX153 ³	VEX173 ³	VEX193 ³
Bracket (With bolt and washer)	B	VEX1-18-1A	—	VEX1-18-1A	—	VEX3-32A	VEX5-32A	VEX7-32A	VEX9-32A
Foot (With bolt and washer)	F	VEX1-18-2A	—	VEX1-18-2A	—	—	—	—	—
Pressure gauge (3)	G	G27-10-R1-X207		G27-10-01		G36-10-01	G46-10-01		
Silencer for bleed port (PE)	N	AN120-M5							

Note 1) Not conforming to ISO1179-1.

Note 2) The optional parts are shipped in the same package.

Note 3) If a pressure gauge other than that which is indicated in the option table is to be used, also enter the part number of the pressure gauge.

Refer to the pressure gauge guide in Best Pneumatics No. 7 for details.

Example: VEX1333-03

G36-4-01

Note 4) Face seal type One-touch fittings cannot be used.

Caution

Using the External Pilot

1. If a pressure difference over 0.1 MPa between the supply and the set pressure cannot be maintained, change to an external pilot to obtain the necessary pressure difference.
2. If a mist separator cannot be installed on the supply side, change to an external pilot, and make sure to install a mist separator on the pilot side.

How to Switch to External Pilot

1. Using a flat head screwdriver, remove the fixed orifice from port P1.
2. Install the fixed orifice facing in the opposite direction (external pilot). Install it carefully to prevent damage to the O-ring.
3. Tighten the fixed orifice again and connect the pilot piping to port P1 using an M5 fitting.

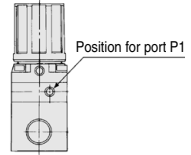

Dimensions of port P1

<Internal pilot>

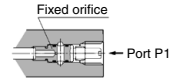

<External pilot>

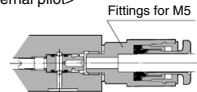

- For VEX1□□3□ (NBR seals)
Fixed orifice assembly (with O-ring) part no.: VEX1-A30-3
- For VEX1□□33B (FKM seals)
Fixed orifice assembly (with O-ring) part no.: VEX1-A30-3B
(Note) O-rings cannot be shipped as a single unit.

ARJ
AR425 to 935
ARX
AMR
ARM
ARP
IR□-A
IR
IRV
VEX
SRH
SRP
SRF
ITV
IC
ITVH
ITVX
PVQ
VY1
VBA
VBAT
AP100

VEX1□3⁰ Series

Sub-plate/Base Gasket Part No.

Valve body size	B	2																																
Sub-plate	<p>VEXB-2-□□P</p> <p>Port size</p> <table border="1"> <thead> <tr> <th>Symbol</th> <th>Port size</th> </tr> </thead> <tbody> <tr> <td>A</td> <td>M5</td> </tr> <tr> <td>B</td> <td>1/8</td> </tr> </tbody> </table> <p>Thread type</p> <table border="1"> <thead> <tr> <th>Symbol</th> <th>Thread type</th> </tr> </thead> <tbody> <tr> <td>Nil</td> <td>Rc</td> </tr> <tr> <td>F</td> <td>G (Note)</td> </tr> <tr> <td>N</td> <td>NPT</td> </tr> <tr> <td>T</td> <td>NPTF</td> </tr> </tbody> </table>	Symbol	Port size	A	M5	B	1/8	Symbol	Thread type	Nil	Rc	F	G (Note)	N	NPT	T	NPTF	<p>VEX1-9-1□□P</p> <p>Port size</p> <table border="1"> <thead> <tr> <th>Symbol</th> <th>Port size</th> </tr> </thead> <tbody> <tr> <td>A</td> <td>1/8</td> </tr> <tr> <td>B</td> <td>1/4</td> </tr> </tbody> </table> <p>Thread type</p> <table border="1"> <thead> <tr> <th>Symbol</th> <th>Thread type</th> </tr> </thead> <tbody> <tr> <td>Nil</td> <td>Rc</td> </tr> <tr> <td>F</td> <td>G (Note)</td> </tr> <tr> <td>N</td> <td>NPT</td> </tr> <tr> <td>T</td> <td>NPTF</td> </tr> </tbody> </table>	Symbol	Port size	A	1/8	B	1/4	Symbol	Thread type	Nil	Rc	F	G (Note)	N	NPT	T	NPTF
Symbol	Port size																																	
A	M5																																	
B	1/8																																	
Symbol	Thread type																																	
Nil	Rc																																	
F	G (Note)																																	
N	NPT																																	
T	NPTF																																	
Symbol	Port size																																	
A	1/8																																	
B	1/4																																	
Symbol	Thread type																																	
Nil	Rc																																	
F	G (Note)																																	
N	NPT																																	
T	NPTF																																	
Base gasket	<p>VEXB-4□</p> <p>Seal material</p> <table border="1"> <thead> <tr> <th>Symbol</th> <th>Seal material</th> </tr> </thead> <tbody> <tr> <td>Nil</td> <td>NBR seals</td> </tr> <tr> <td>B</td> <td>FKM seals</td> </tr> </tbody> </table>	Symbol	Seal material	Nil	NBR seals	B	FKM seals	VEX1-11-2																										
Symbol	Seal material																																	
Nil	NBR seals																																	
B	FKM seals																																	

Note) Not conforming to ISO1179-1.

VEX1□3⁰ Series

Manifold Specifications

Specifications

Applicable valve	VEX1B33		VEX123 ⁰					
Valve stations	2 to 10 stations <small>Note</small>		2 to 8 stations <small>Note</small>					
Air passage	Common supply/exhaust							
Pilot	Internal pilot	Common external pilot	Internal pilot	Common external pilot				
Pilot port size	—	M5 x 0.8	—	M5 x 0.8				
Port size Port 1 (P), 2(A), 3(R)	1/8		1/4					
Blanking plate	VEXB-5 □ (With gasket and mounting bolt) ↓ Seal material <table border="1"> <tr> <td>Nil</td> <td>NBR seals</td> </tr> <tr> <td>B</td> <td>FKM seals</td> </tr> </table>		Nil	NBR seals	B	FKM seals	VEX1-17 (With gasket and mounting bolt)	
Nil	NBR seals							
B	FKM seals							

Note) Pressurize to Port 1(P) and exhaust from Port 3(R) on the both sides for six stations or more of "VEX1B33" and/or five stations or more of "VEX1233".



How to Order

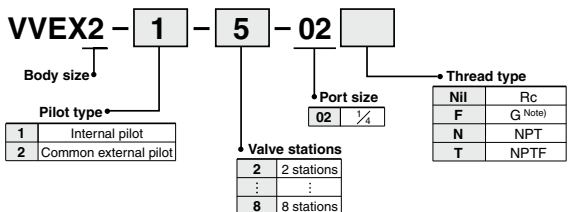
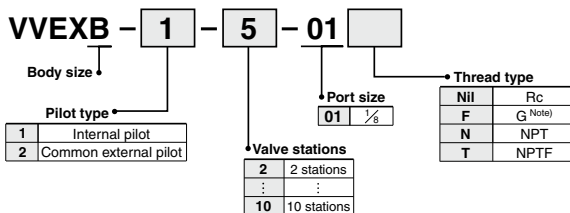

List symbols in the order of precision regulators and blanking plates for manifolds from the left-hand side (Port 2(A) faces this side) of the manifold base.

Ex.) VVEX2-2-5-02

* VEX1233-G — 4 pieces

* VEX1-17 — 1 piece

Note) Not conforming to ISO1179-1.

Set Pressure Characteristics (Air Operated Type)

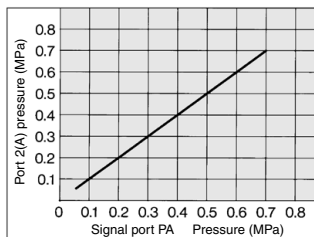

Set Pressure Characteristics (Manual Knob Type)

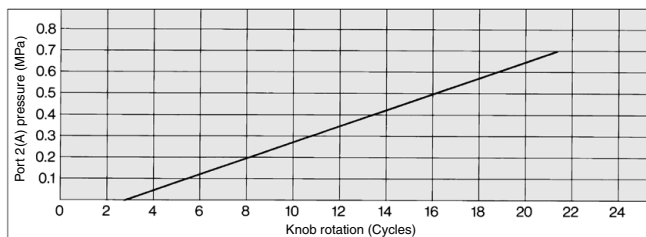

ARJ

AR425 to 935

ARX

AMR

ARM

ARP

IR□-A

IR

IRV

VEX

SRH

SRP

SRF

ITV

IC

ITVH

ITVX

PVQ

VY1

VBA

VBAT

AP100

Flow Rate Characteristics

Port 1(P) pressure: 1 MPa

VEX1A33, VEX1B33-01

Port 2(A) pressure (MPa)

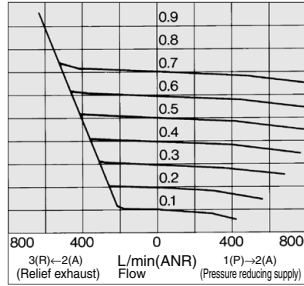

VEX113⁰, VEX123⁰-02

Port 2(A) pressure (MPa)

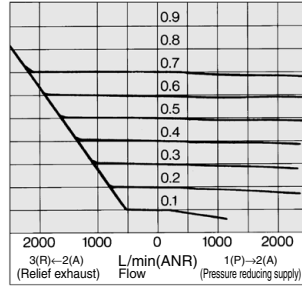

VEX133⁰-03

Port 2(A) pressure (MPa)

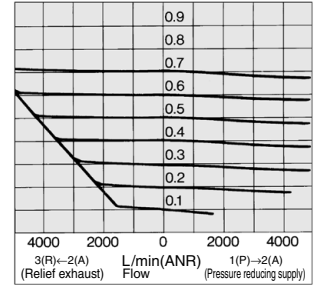

VEX153⁰-06

Port 2(A) pressure (MPa)

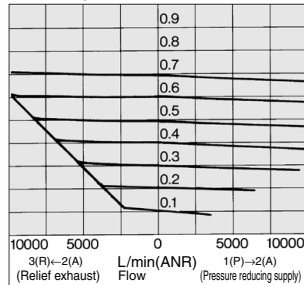

VEX173⁰-12

Port 2(A) pressure (MPa)

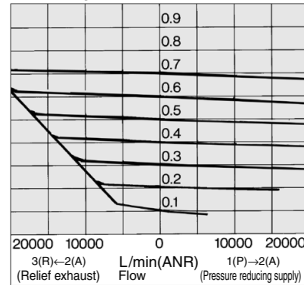

VEX193⁰-20

Port 2(A) pressure (MPa)

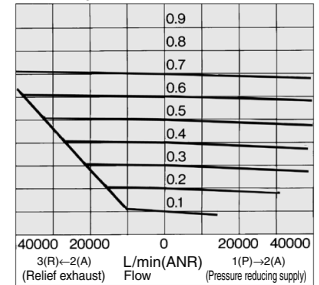

Pressure Characteristics

Port 1(P) pressure: 0.7 MPa, Port 2(A) pressure: 0.2 MPa, Flow: 0 L/min (ANR)

VEX1A33, VEX1B33

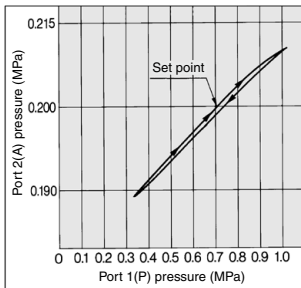

VEX113⁰, VEX123⁰

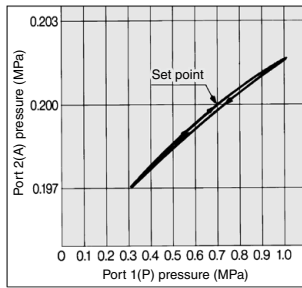

VEX133⁰

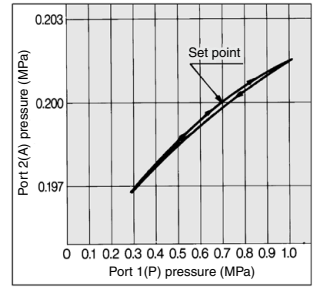

VEX153⁰

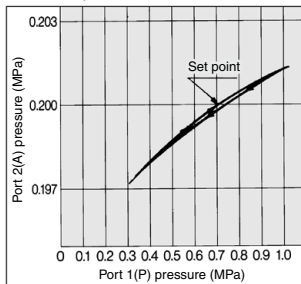

VEX173⁰

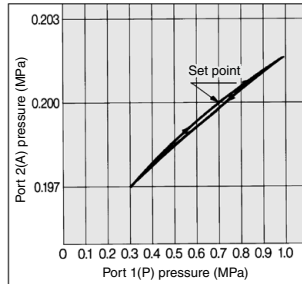

VEX193⁰

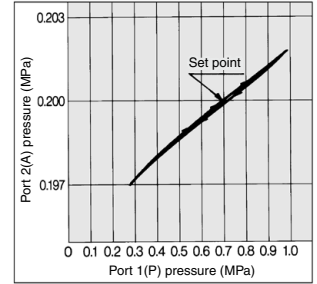

Construction/Working Principle

VEX1A33, VEX1B33

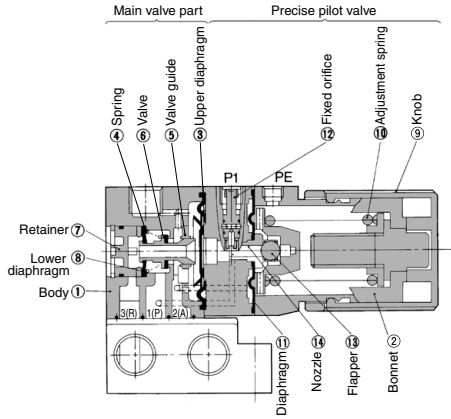

When set-knob ⑨ is turned clockwise, the force generated by set spring ⑩ causes flapper ⑬ to close nozzle ⑭, allowing the nozzle back pressure to be applied to the right surface of top diaphragm ③. Then, valve ⑥ moves to the left, allowing the supply air to flow from port 1(P) to port 2(A). The air pressure that has flowed in is applied to the left surface of top diaphragm ③ and counteracts the force generated by the nozzle back pressure; at the same time, it is applied to the left surface of diaphragm ⑪, and balances with the set pressure that counteracts the compression force of set spring ⑩.

When the outlet pressure increases higher than the set pressure, it pushes diaphragm ⑪ towards the right, and the pressure at the right side of top diaphragm ③ decreases, causing top diaphragm ③ to move to the right. Then, valve ⑥ moves away from the left surface of top diaphragm ③, the outlet pressure flows from port 2(A) via the valve hollow and is discharged through port 3(R) (atmosphere). If set knob ⑨ is turned counterclockwise, the movement will be the opposite, the outlet pressure will decrease, and will balance with a newly set pressure.

Component Parts

No.	Description	Material
1	Body	Zinc alloy die-casted
2	Bonnet	Aluminum alloy die-casted
3	Upper diaphragm	NBR/FKM
4	Spring	Stainless steel
5	Valve guide	Stainless steel
6	Valve	NBR/FKM
7	Retainer	Resin
8	Lower diaphragm	NBR/FKM

Replacement Parts

No.	Description	Part no.
9	Knob	VBA1-10#1

VEX113⁰₃, VEX123⁰₃, VEX133⁰₃, VEX153⁰₃ VEX173⁰₃, VEX193⁰₃

Manual knob type

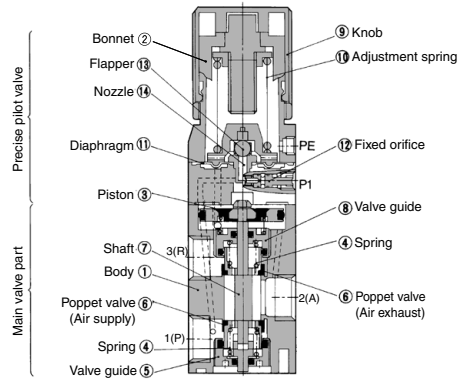

Air operated type

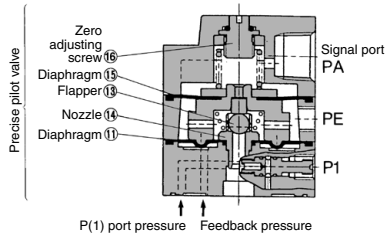

When set-knob ⑨ is turned clockwise, the force generated by set spring ⑩ causes flapper ⑬ to close nozzle ⑭, allowing the nozzle back pressure to be applied to the top of piston ③. Then, via shaft ⑦, poppet valve (supply air) ⑥ opens, allowing the supply air to flow from port 1(P) to port 2(A). The air pressure that has flowed in is applied to the bottom surface of piston ③ and counteracts the force generated by the nozzle back pressure; at the same time, it is applied to the bottom surface of diaphragm ⑪, and balances with the set pressure that counteracts the compression force of set spring ⑩. When the outlet pressure increases higher than the set pressure, it pushes the diaphragm ⑪ upward, the pressure at the top surface of piston ③ decreases, causes piston ③ to move upward, opens poppet valve (exhaust) ⑥ via shaft ⑦, and is discharged through port 3(R) to the atmosphere.

If set-knob ⑨ is turned counterclockwise (if the set pressure of the pressure-reducing valve connected to the signal port is decreased), the movement will be the opposite; the outlet pressure will decrease and balance with a newly set pressure.

Note) Those indicated in parentheses are for the air operated type.

Component Parts

No.	Description	Material
1	Body	Aluminum alloy die-casted
2	Bonnet	Aluminum alloy die-casted
3	Regulating piston	Aluminum alloy
4	Spring	Stainless steel
5	Valve guide	Aluminum alloy
6	Poppet valve	NBR
7	Shaft	Stainless steel
8	Valve guide	Aluminum alloy

Replacement Parts

No.	Description	Part no.
9	Knob	VBA1-10#1

ARJ
AR425 to 935
ARX
AMR
ARM
ARP
IR□-A
IR
IRV
VEX
SRH
SRP
SRF
ITV
IC
ITVH
ITVX
PVQ
VY1
VBA
VBAT
AP100

VEX1□3⁰ Series



Body Ported

VEX1A33-M5, 01

A section view

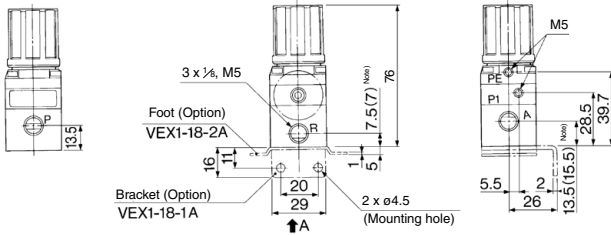
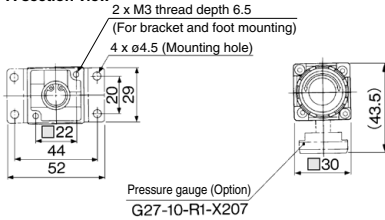

Note) () are the dimensions of "M5".

VEX113⁰-01, 02

A section view

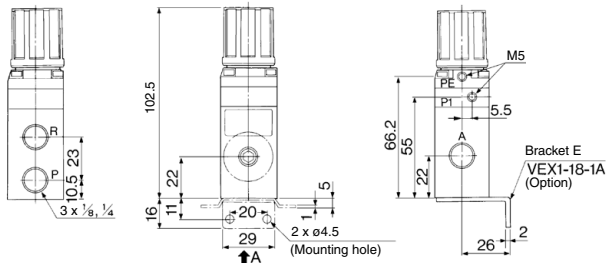
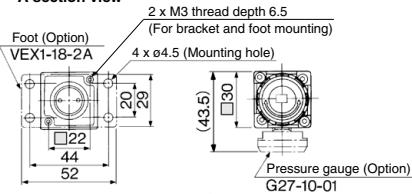

Air operated type

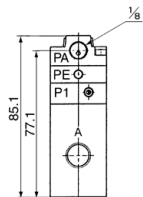



Body Ported

VEX133⁰-02, 03, 04

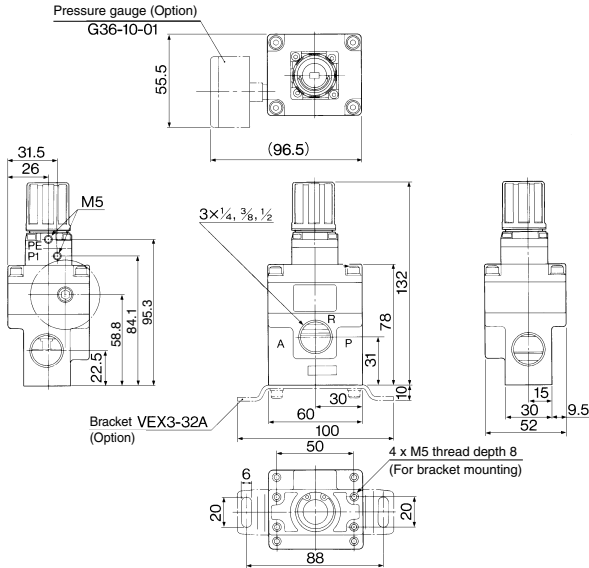

Air operated type

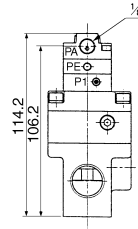

VEX153⁰-04, 06, 10

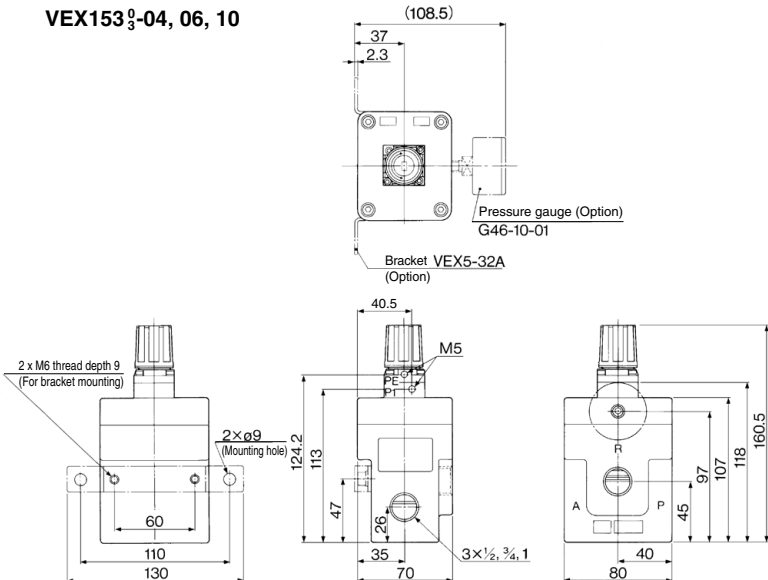

Air operated type

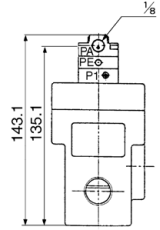

ARJ
AR425 to 935
ARX
AMR
ARM
ARP
IR□-A
IR
IRV
VEX
SRH
SRP
SRF
ITV
IC
ITVH
ITVX
PVQ
VY1
VBA
VBAT
AP100

VEX1□3⁰ Series



Body Ported

VEX173⁰-10, 12

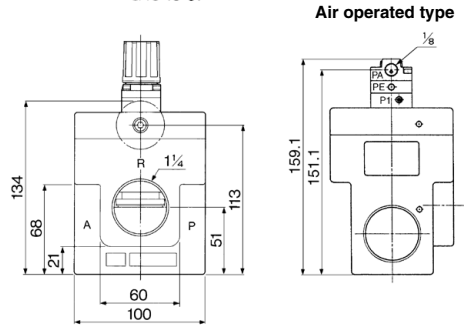
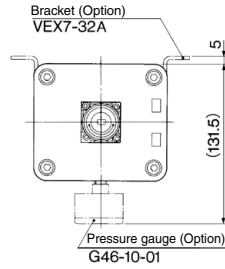
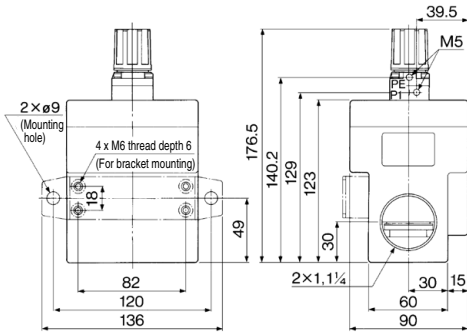

VEX193⁰-14, 20

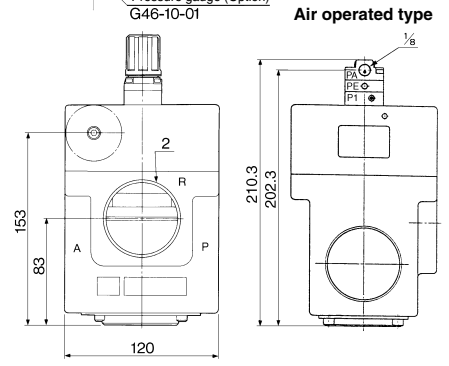
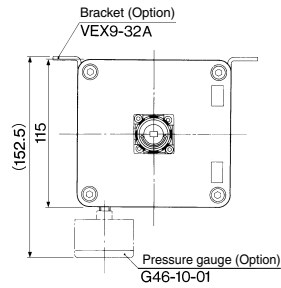
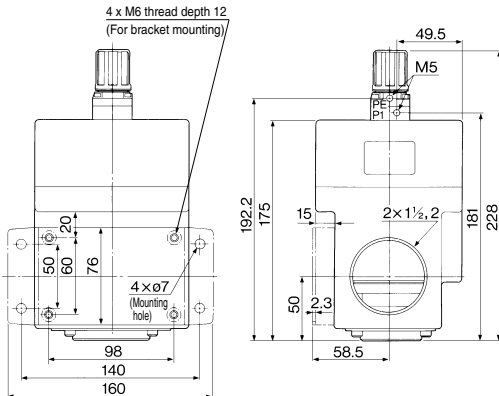



Base Mounted

VEX1B33-M5, 01

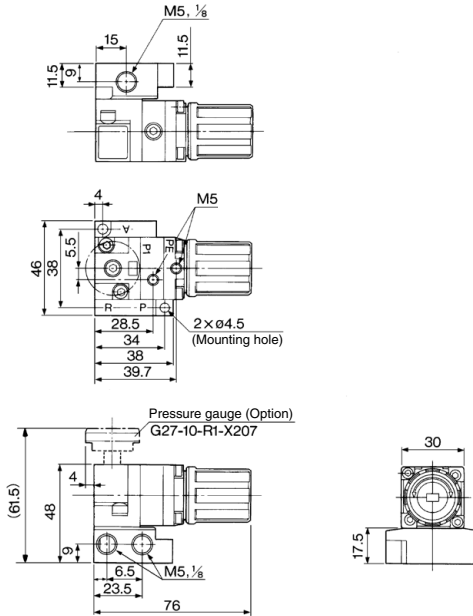

VEX123⁰-01, 02

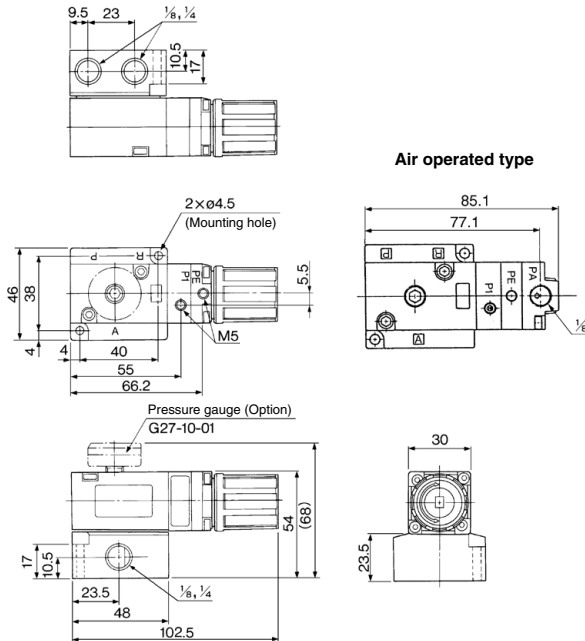

ARJ
AR425 to 935
ARX
AMR
ARM
ARP
IR□-A
IR
IRV
VEX
SRH
SRP
SRF
ITV
IC
ITVH
ITVX
PVQ
VY1
VBA
VBAT
AP100

VEX1□3⁰ Series



Manifold: VVEXB-□-□-01

Applicable valve: VEX1B33

Valve mounting side

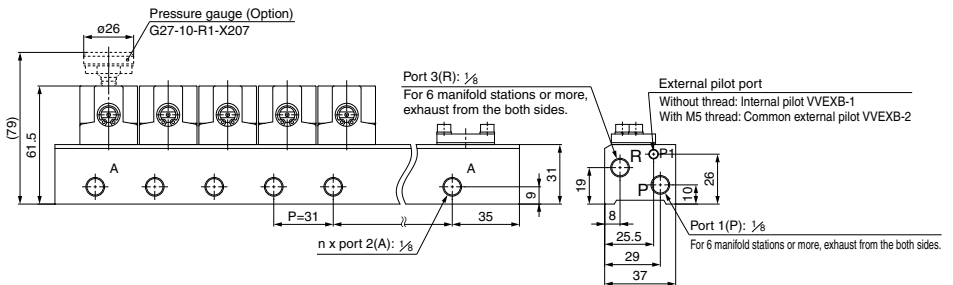
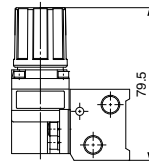
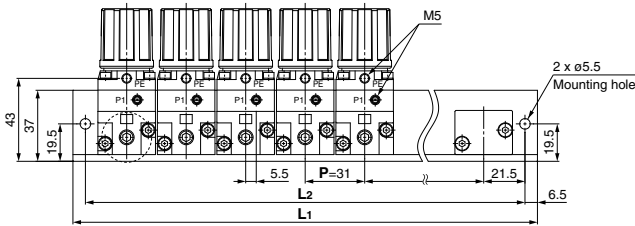
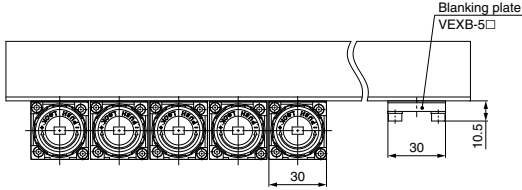
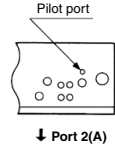

L Dimension

$L_1 = 31n + 25$, $L_2 = 31n + 12$ n: Station

Symbol	n	2	3	4	5	6	7	8	9	10
L ₁		87	118	149	180	211	242	273	304	335
L ₂		74	105	136	167	198	229	260	291	322



Manifold: VVEX2-□-□-02

Applicable valve: VEX123⁰₃

Valve mounting side

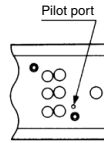

Internal pilot
VVEX2-1

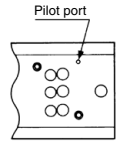

Common external pilot
VVEX2-2

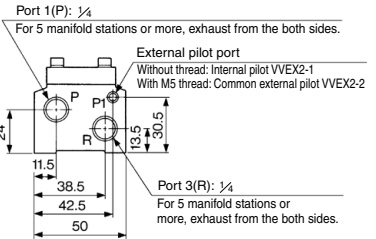
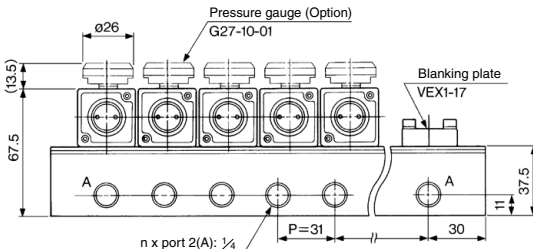
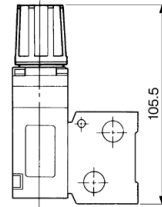
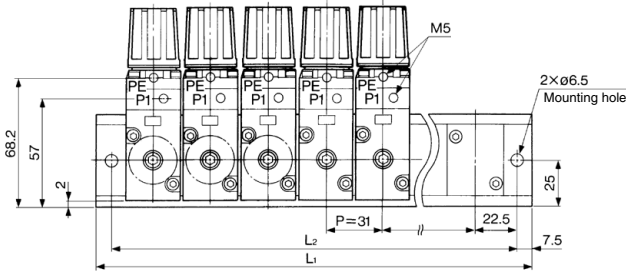
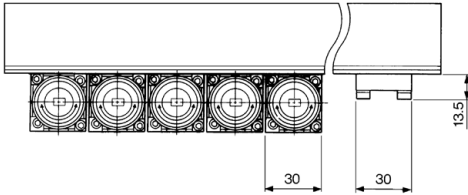

L Dimension

$L_1 = 31n + 29$, $L_2 = 31n + 14$ n: Station

Symbol	n	2	3	4	5	6	7	8
L_1		91	122	153	184	215	246	277
L_2		76	107	138	169	200	231	262

ARJ

AR425
to 935

ARX

AMR

ARM

ARP

IR□-A

IR

IRV

VEX

SRH

SRP

SRF

ITV

IC

ITVH

ITVX

PVQ

VY1

VBA

VBAT

AP100

⚠️ Precautions

Be sure to read this before handling the products. Refer to back page 50 for Safety Instructions and pages 387 to 391 for Precautions on every series.

Operating Fluid

⚠️ Caution

- If drainage or debris is present in the supply pressure line, the fixed orifice becomes clogged, resulting in a malfunction. Therefore, in addition to the air filter (SMC's AF series), make sure to use a mist separator (SMC's AM, AFM series). Concerning the quality of the operating air, refer to SMC's air preparation equipment selection guide (pages 2 and 3).
- Make sure to perform a maintenance periodically on air filter and mist separator by discharging the drain and cleaning a filter element or replacing with new one).
- Never use a lubricator on the supply side with the internal pilot remaining in place, doing so will cause the fixed orifice to become clogged, invariably leading to a malfunction.
- When lubrication to terminal device is required: Connect a lubricator on the supply [port 1 (P)] side using the external pilot type. Use mist separator passage on the pilot air [port P1] side.
- Use a supply pressure in the recommended range (the range indicated in the diagram below).

VEX1A33, VEX1B33

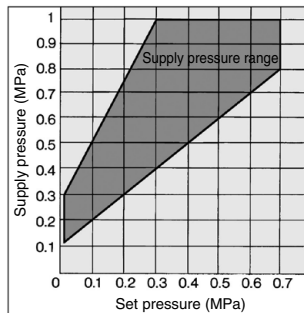

VEX113³, VEX123³, VEX133³ VEX153³, VEX173³, VEX193³

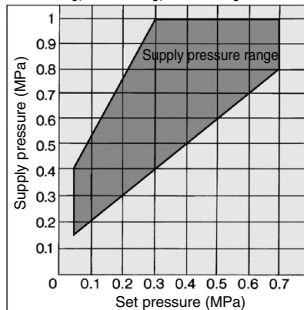

Piping

⚠️ Warning

- Use the flow rate characteristics on page 846 as reference to select a regulator size so that the required flow rates on the reduced pressure supply and relief exhaust sides have sufficient allowances.
If the reduced pressure supply and relief exhaust that may cause extreme changes in flow rate are repeated (main valve is fully opened and closed repeatedly), the nozzle flapper is deformed. This may cause the pressure set value to deviate or the diaphragm to break early. So, do not use under such conditions.

⚠️ Caution

1. Tightening the fittings and their torque

When screwing fittings into the valve, make sure to tighten them to the proper torque values given below.

● Connection thread: M5

First, tighten by hand, then use a wrench appropriate for the hexagon flats of the body to tighten an additional 1/6 to 1/4 turn.

A reference value for the tightening torque is 1 to 1.5 N·m.

● Use the fitting with sealant as the Uni One-touch fitting cannot be used.

● For the fitting with sealant R or NPT, first, tighten it by hand, then use a wrench appropriate for the hexagon flats of the body to tighten it a further two or three turns. For a tightening torque guide, refer to the table below.

Connection thread size (R, NPT)	Proper tightening torque (N·m)
1/8	3 to 5
1/4	8 to 12
3/8	15 to 20
1/2	20 to 25
3/4	28 to 30
1	36 to 38
1 1/4	40 to 42
1 1/2	48 to 50
2	48 to 50

- Ordinarily, air is discharged from the bleed port (PE). The consumption of air through this discharge is normal, owing to the construction of the precision pressure regulator.

Regulator for Signals (Air operated type only)

⚠️ Caution

- Applicable model
Regulator IR2000 series
VEX1³33 series
- In the case of multiple pressure control, consider using ITV series or the E-P HYREG[®] VY series, which can simplify your system.

Zero Adjustment Screw

⚠️ Caution

- Before being shipped from the factory, the zero adjustment screw is adjusted so that the signal pressure and the output pressure are set as close to 1:1 as possible, so please refrain from making any further adjustments yourself. Adjusting the screw may result in the output pressure value deviating from the set value.

Vibration

⚠️ Caution

Vibration is likely to occur under the following conditions.

- Supply pressure is relatively high (approx. 0.5 MPa or higher), set pressure is low (approx. 0.1 MPa or lower) and the outlet side is open to the atmosphere.
- Capacity of the precision regulator outlet side is extremely small.

The following measures can be taken.

- Set the supply pressure extremely low (+0.1 MPa or more of the set pressure).
- Make the capacity of the precision regulator outlet side larger.
- Install an exhaust throttle valve with a silencer (ASN2-M5) on the bleed port (PE). Vibration can be avoided by adjusting the exhaust throttle. However, if the bleed is throttled too much, sensitivity may be reduced, resulting in poor performance. Be sure not to apply excessive throttle.

Related Products:

Silencer (AN series)

- Noise reduction capability of over 30 dB.
- Provides a sufficient effective area.

For details, refer to Best Pneumatics No. 7.

Exhaust cleaner (AMC series)

- Provides noise reduction and oil mist recovery functions.
- Can also be used in an intensive piping system.
- Oil mist removal of 99.9%
- Noise reduction of over 35 dB.

For details, refer to Best Pneumatics No. 7.