

Coolant Valve

SGC Series

0.5 MPa **1.0 MPa** **1.6 MPa**



IP65 compliant

For pilot valve V116

1 1/4 (32A) to 2 (50A) added.

Flow rate Cv (For 0.5 MPa specification)

Variations

Series	Cv (kv)	Port size
SGC2	6.5 (6.6)	3/8 (10A), 1/2 (15A)
SGC3	11.8 (10.1)	3/4 (20A)
SGC4	18.3 (15.7)	1 (25A)
SGC5	28 (24)	1 1/4 (32A)
SGC6	43 (36.9)	1 1/2 (40A)
SGC7	70 (60)	2 (50A)

Service life:

5 million cycles or more

(For the SGC2, 3, 4, based on SMC's test condition)

Power consumption:

0.35 w*/1.8 w*

* For 24 VDC

Water hammer:

Reduced by 30%*

* Compared to current model, VNC series

* For 0.35 W type, SGC2 to 7

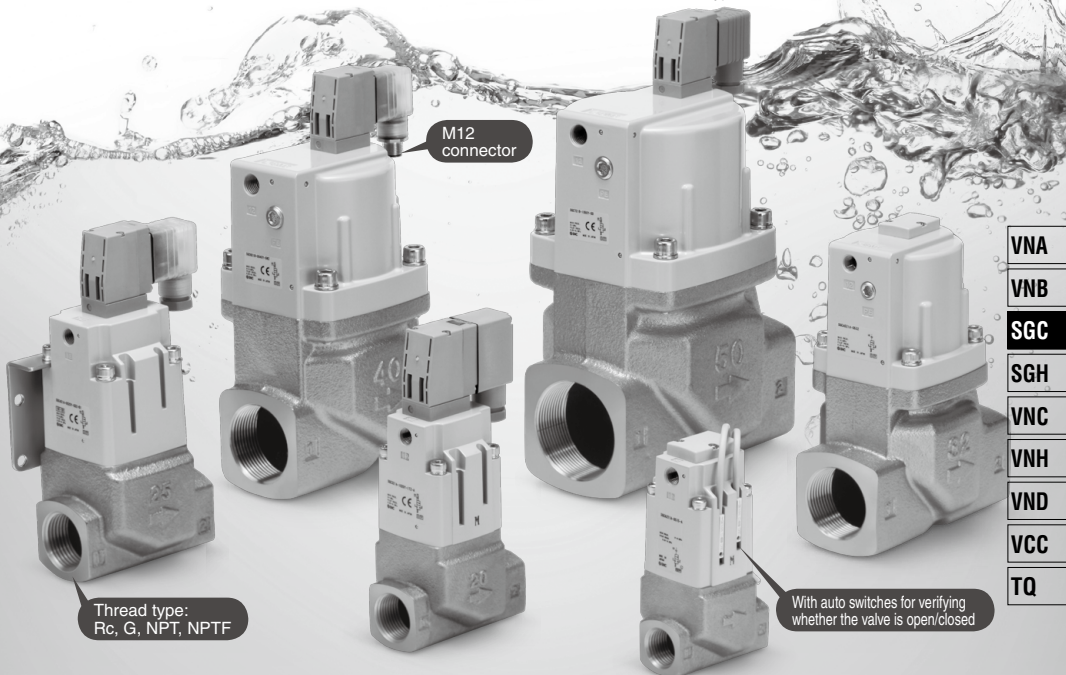

M12 connector

Thread type:
Rc, G, NPT, NPTF

With auto switches for verifying
whether the valve is open/closed

- VNA
- VNB
- SGC**
- SGH
- VNC
- VNH
- VND
- VCC
- TQ

Coolant Valve SGC Series

(For Air Operated Type)

Dry bearings

Prevents the shaft, which is a sliding part, from vibrating and helps to extend the service life of the rubber components and improves the seal performance of the main valve.

Squeeze seal

Completely shuts off the leakage of liquid coolant and increases the scraper effects. These two safety designs result in a dual advantage.

Scraper

Prevents foreign matter from entering, while the main valve is activated.

• Choice of seal materials
NBR, FKM

Auto switch

Able to confirm whether the valve is open/closed. Mountable on the 2 sides.
(SGC2, 3, 4 only)

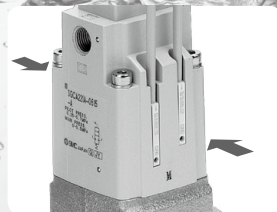

• Magnet (SGC2, 3, 4 only)

Grease channel

Prevents the loss of grease and helps to extend the service life.

IN

OUT

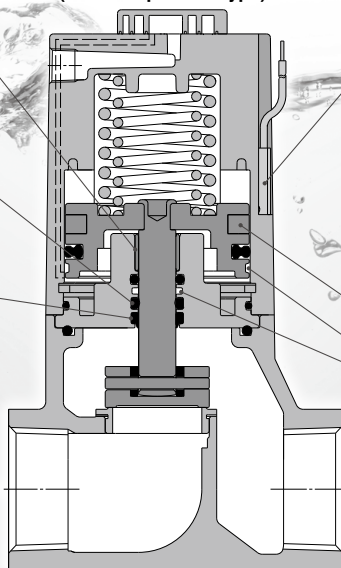

For External Pilot Solenoid Type

Type	SGC2	SGC3	SGC4	SGC5	SGC6	SGC7
0.35 W type <small>Note 1)</small>	●	●	●	●	●	●
1.8 W type <small>Note 1) 2)</small>	*	*	*	●	●	●

Note 1) For DC voltage. Refer to page 582 for models with indicator light and AC voltage (apparent power VA).

Note 2) The response time is equivalent to the VNC series.

* Made to Order (See page 591.)

Variations (Common specifications for external pilot solenoid type and air operated type)

Series	Port size	Thread type	Type of actuation	Operating pressure range [MPa]	Cv	kv	Electrical entry (For external pilot solenoid type)	Bracket	
SGC2	3/8 (10A)	Rc G (ISO1179-1) NPT NPTF	N.C./N.O.	0.5	4.6	3.9	<ul style="list-style-type: none"> Conduit terminal DIN terminal M12 connector 	<ul style="list-style-type: none"> Bracket on the left side 	
				1	3.5	3			
				1.6	1.25	1.1			
	0.5			6.5	5.6				
	1			4.8	4.1				
SGC3	3/4 (20A)			0.5	11.8	10.1		<ul style="list-style-type: none"> Bracket on the right side 	
				1	7.1	6.1			
				1.6	4.5	3.9			
SGC4	1 (25A)			0.5	18.3	15.7			<ul style="list-style-type: none"> Bracket on the right side
				1	11.0	9.4			
		1.6	7.3	6.3					
SGC5	1 1/4 (32A)	0.5	28	24	<ul style="list-style-type: none"> Bracket on the right side 				
		1	20	17.1					
SGC6	1 1/2 (40A)	0.5	43	36.9		<ul style="list-style-type: none"> Bracket on the right side 			
		1	30	25.7					
SGC7	2 (50A)	0.5	70	60			<ul style="list-style-type: none"> Bracket on the right side 		
		1	48	41.1					

Reduced Coolant Blow Energy Consumption

Coolant pump

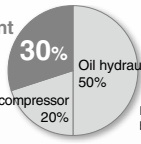

Electric power consumption by purpose (SMC research)

Reduced electric power for coolant pump

- Reduced number of pump units
- Pump downsized

Research has revealed that coolant pumps account for 30% of the electric power consumption in a production facility. By reducing the energy consumption for coolant blow, it will substantially contribute to the electric reduction in the whole factory.

Improvement Example case 1

Improvement in Pressure Loss

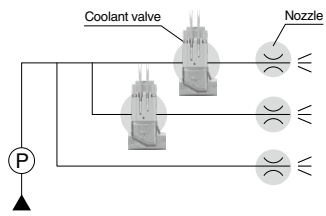

Pressure loss is improved by making the effective area ratio 2 : 1 between the upstream side and the nozzle.

- Making the effective area in the upstream side larger.
- (Changing to the equipment with larger effective area)
- Attaching a nozzle.

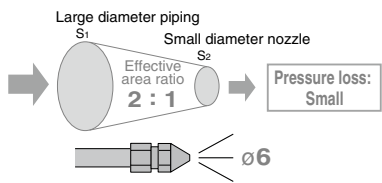

Effect of Energy Saving Improvement

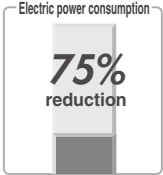
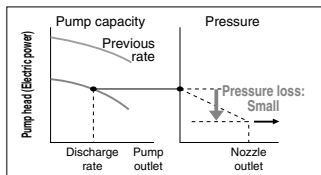

Improvement Example case 2

Intermittent Blow

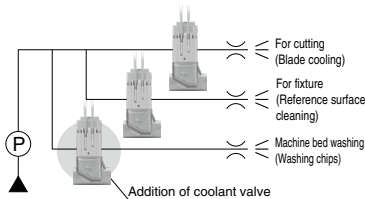

Stops machine bed-washing all the time. Machine bed washing is stopped when blowing for cutting or fixture by means of a valve.

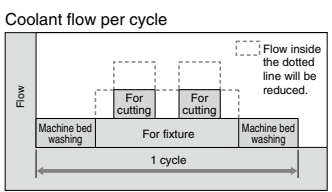
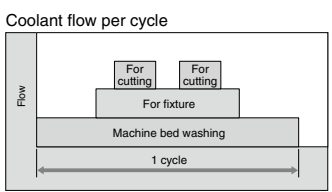

Effect of Energy Saving Improvement

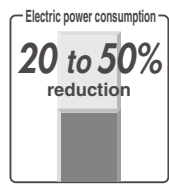

- VNA
- VNB
- SGC**
- SGH
- VNC
- VNH
- VND
- VCC
- TQ

Coolant Blow System/ Related Equipment

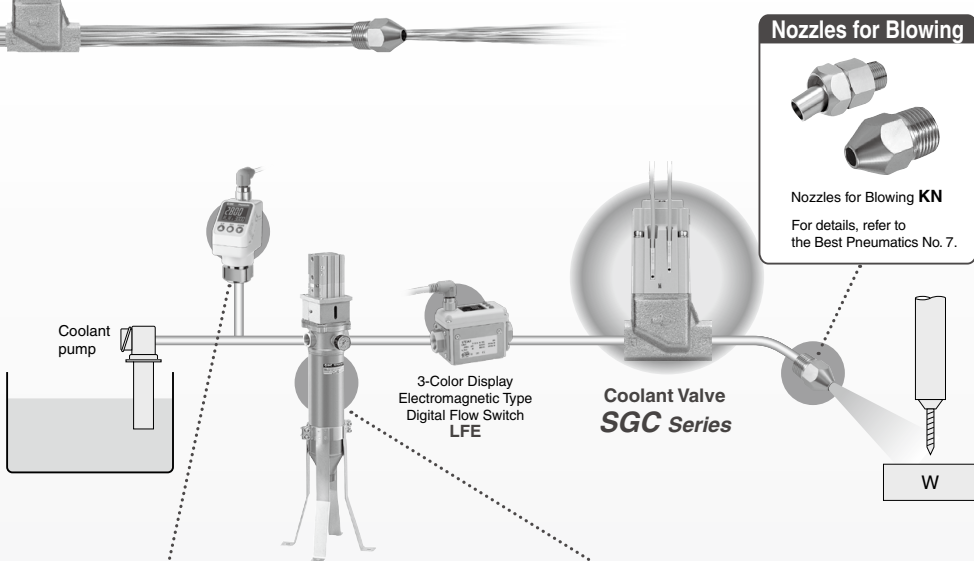

Pressure Switches

Coolant line pressure control

Self-contained Type

- High-Precision Digital Pressure Switch ISE7□G (For 1/2/5/10 MPa)
- Digital Pressure Switch ISE75H (For 15 MPa)



- 3-Screen Display High-Precision Digital Pressure Switch ISE20C(H)



Remote Type

- Pressure Sensor for General Fluids PSE57□



- 3-Screen Display Sensor Monitor PSE300AC



- General Purpose Pressure Switch ISG



For details, refer to the Best Pneumatics No. 8.

Filters

Coolant liquid filtration

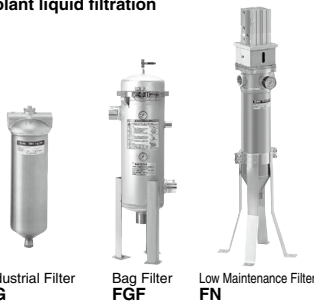

Industrial Filter FG

Bag Filter FGF

Low Maintenance Filter FN

For details, refer to the Best Pneumatics No. 11.

Energy Saving Related Materials

For details, refer to the SMC website.

<http://www.smcworld.com> SMC Model Selection Software Search

Energy Saving Program

Allows you to perform various calculations necessary to improve the pneumatic energy saving.



Download this program

Ver. 4.0.0 2013/04/25 Update

How to install

Model Selection Software

Allows you to select an optimal system model to efficiently operate the air cylinder, etc.

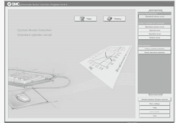

Download this program

Ver. 4.0.10 2013/04/24 Update

Application Manual

How to install

Water Resistant Cylinders

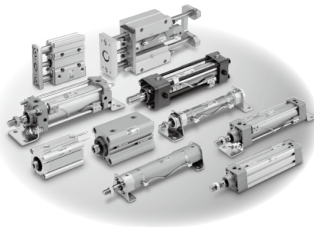

For details, refer to the Best Pneumatics No. 2-1.



CONTENTS

Coolant Valve *SGC Series*

How to Order	Page 580
Characteristics	Page 581
Valve Specifications	Page 581
How to Order Pilot Valves	Page 582
Pilot Solenoid Valve Specifications	Page 582
Construction	Page 583
Dimensions	
Air Operated	Page 584
External Pilot Solenoid	Page 585
How to Fix an Auto Switch	Page 588
Auto Switch Proper Mounting Position	Page 588
Options	Page 588
Auto Switch	Page 589
Made to Order	Page 591
Specific Product Precautions	Page 592

VNA

VNB

SGC

SGH

VNC

VNH

VND

VCC

TQ

Coolant Valve

SGC Series



How to Order



Made to Order
(For details, refer to page 591.)

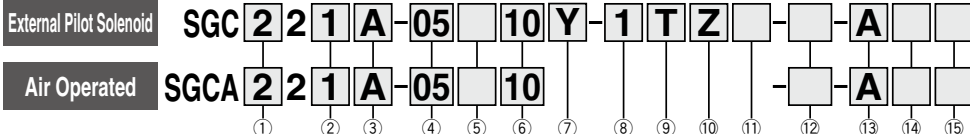

① Series

2	SGC200
3	SGC300
4	SGC400
5	SGC500
6	SGC600
7	SGC700

② Valve type

1	N.C.
2	N.O.

③ Seal material

A	NBR
B	FKM

④ Pressure range

05	0 to 0.5 MPa
10	0 to 1 MPa
16*	0 to 1.6 MPa

* Only available for 2, 3, 4 series.

⑤ Thread type

Nil	Rc
G	G (ISO1179-1)
N	NPT
T	NPTF

⑥ Port size

10	3/8	SGC200
15	1/2	SGC300
20	3/4	SGC300
25	1	SGC400
32	1 1/4	SGC500
40	1 1/2	SGC600
50	2	SGC700

⑦ Pilot valve

Symbol	Pilot valve	SGC2	SGC3	SGC4	SGC5	SGC6	SGC7
Y	0.35 W type (V116)	○	○	○	○	○	○
H	1.8 W type (VO307)	—*	—*	—*	○	○	○

Note) 0.35 W type (Pilot valve V116) is a low wattage specification. The response is slower than VNC series. If the response time is a problem, use the 1.8 W type (VO307). Please note that the power consumption is 1.8 W (With indicator light: 2 W).





* For the 1.8 W type SGC2/3/4, refer to the made-to-order specification (SGC2/3/4-X1, Pilot valve SF4) on page 591.

⑧ Rated voltage

1	100 VAC 50/60 Hz
2	200 VAC 50/60 Hz
3	110 VAC [115 VAC] 50/60 Hz
4	220 VAC [230 VAC] 50/60 Hz
5	24 VDC
6	12 VDC

Note) Refer to page 592 when using with energization for long periods of time.

⑨ Electrical entry

T: Conduit terminal (Pilot valve V116 only) Note 2) 	D: DIN terminal (Pitch between the terminals: 11 mm) 	DO: DIN terminal without connector Note 1) 	W: M12 connector (4-pin type) Note 3) 
			V: M12 connector (5-pin type) Note 3) 4) 

Note 1) Refer to the table (1) below for combinations with light/surge voltage suppressors.

Note 2) Not available for H (1.8 W type).

Note 3) Cable for M12 connector is not included. Order it separately after referring to the options on page 588.

Note 4) Only DC voltage is available.

⑩ Light/surge voltage suppressor

Nil	None
S	With surge voltage suppressor
Z	With light/surge voltage suppressor

Note) Refer to Table (1) below for combinations with electrical entry.

⑪ Manual override

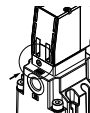
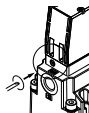
Nil: Non-locking push type 	D: Push-tum locking lever type Note) 
---	---

Note) Only available for Y (0.35 W type).

⑫ Bracket mounting position

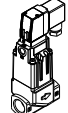
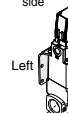
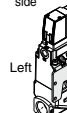
Nil: Without bracket 	B1: Bracket on the left side 	B2: Bracket on the right side 
---	---	--

Note) Bracket cannot be attached later.

* Only available for 2, 3, 4 series.

Table (1) Electrical Entry/Light/Surge Voltage Suppressor

Pilot valve	Rated voltage	Electrical entry	Without light/surge voltage suppressor	With surge voltage suppressor	With light/surge voltage suppressor
			Nil	S	Z
0.35 W type (V116)	AC	T	—	●	●
		D	—	●	●
		W	—	●	●
	DC	DO	● (Note)	—	—
		T	—	—	—
		D	—	—	—
1.8 W type (VO307)	AC	W, V	—	—	—
		DO	—	—	—
		D	—	—	—
	DC	W, V	—	—	—
		DO	—	—	—
		D	—	—	—

Note) When AC voltage (V116) without DIN terminal (DO) is selected, always use a DIN connector with surge voltage suppressor as the connector.

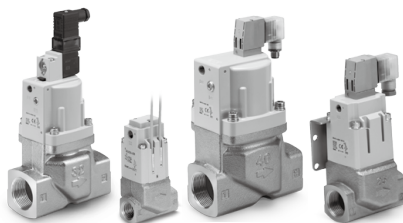

13 Auto switches (for verifying whether the valve is open/closed)

Nii	Without auto switch (without magnet)
M	Without auto switch (with built-in magnet)
A	With auto switch Select a model, referring to the table "Applicable Auto Switches" below.
B	
C	
E	
F	
G	

* Auto switches are shipped together, (but not assembled).
* Only available for 2, 3, 4 series.

14 Lead wire length

Nil	0.5 m
M	1 m
L	3 m
Z	5 m

* 0.5 m (Nil), 1 m (M), and 5 m (Z) for D-M9□A will be produced on receipt of order.
* Only available for 2, 3, 4 series.

15 Number of auto switches

Nil	2 pcs.
S	1 pc.

* Only available for 2, 3, 4 series.

Applicable Auto Switches Refer to the Best Pneumatics No. 2-1 catalog for detailed auto switch specifications.

Solid State Auto Switch

Symbol	Part no. In-line	Special function	Electrical entry	Indicator light	Wiring (Output)	Load voltage DC		Applicable load	
						5 V, 12 V	12 V	IC circuit	Relay, PLC
A	D-M9N	Water resistant (2-color indicator)	Grommet	Yes	3-wire (NPN)	24 V	5 V, 12 V	IC circuit	Relay, PLC
B	D-M9P				3-wire (PNP)				
C	D-M9B				2-wire				
E	D-M9NA				3-wire (NPN)				
F	D-M9PA				3-wire (PNP)				
G	D-M9BA				2-wire				

Symbol

Type of actuation	N.C.	N.O.
Air operated	SGCA□21□	SGCA□22□
External pilot solenoid	SGC□21□	SGC□22□

Characteristics

Pressure type	Model	Port size	Orifice dia. ø [mm]	Flow rate characteristics			Weight [kg]	
				Kv	Conversion Cv	Air operated	External pilot solenoid	
0.5 MPa	SGC(A)22□□-05□10	3/8	ø15	3.9	4.6	0.69 (0.74)	0.73 (0.78)	
	SGC(A)22□□-05□15	1/2	ø15	5.6	6.5	0.69 (0.74)	0.73 (0.78)	
	SGC(A)32□□-05□20	3/4	ø20	10.1	11.8	1.04 (1.11)	1.08 (1.15)	
	SGC(A)42□□-05□25	1	ø25	15.7	18.3	1.70 (1.77)	1.74 (1.81)	
	SGC(A)52□□-05□32	1 1/4	ø32	24.0	28	3.4	3.4	
	SGC(A)62□□-05□40	1 1/2	ø40	36.9	43	5.6	5.6	
1.0 MPa	SGC(A)72□□-05□50	2	ø51	60.0	70	8.4	8.4	
	SGC(A)22□□-10□10	3/8	ø12	3.0	3.5	0.69 (0.74)	0.73 (0.78)	
	SGC(A)22□□-10□15	1/2	ø12	4.1	4.8	0.69 (0.74)	0.73 (0.78)	
	SGC(A)32□□-10□20	3/4	ø14	6.1	7.1	1.04 (1.11)	1.08 (1.15)	
	SGC(A)42□□-10□25	1	ø17	9.4	11	1.70 (1.77)	1.74 (1.81)	
	SGC(A)52□□-10□32	1 1/4	ø25	17.1	20	3.4	3.4	
1.6 MPa	SGC(A)62□□-10□40	1 1/2	ø29	25.7	30	5.6	5.6	
	SGC(A)72□□-10□50	2	ø36	41.1	48	8.4	8.4	
	SGC(A)22□□-16□10	3/8	ø 9	1.1	1.25	0.69 (0.74)	0.73 (0.78)	
	SGC(A)22□□-16□15	1/2	ø 9	2.3	2.7	0.69 (0.74)	0.73 (0.78)	
	SGC(A)32□□-16□20	3/4	ø12	3.9	4.5	1.04 (1.11)	1.08 (1.15)	
	SGC(A)42□□-16□25	1	ø15	6.3	7.3	1.70 (1.77)	1.74 (1.81)	

* (): Weight including the bracket
* Add the weight of an auto switch additionally.

Valve Specifications

Fluid	Coolant (Water cannot be used.)	
Fluid temperature	SGC□□□□A, B -5 to 60°C*	
Ambient temperature	-5 to 50°C*	
Proof pressure	SGC(A)2, SGC(A)3, SGC(A)4	2.4 MPa
	SGC(A)5, SGC(A)6, SGC(A)7	1.5 MPa
Leakage from the valve seat	20 cm ³ /min or less (Coolant pressure)	
Operating pressure range	SGC□□□□□-05	0 to 0.5 MPa
	SGC□□□□□-10	0 to 1 MPa
	SGC□□□□□-16	0 to 1.6 MPa (2, 3, 4 series only)
External pilot air	Pressure	SGC□□□□1 0.25 to 0.7 MPa SGC□□□□2 0.5 MPa type: 0.25 MPa to 0.7 MPa 1.0, 1.6 MPa type: 0.3 MPa to 0.7 MPa
	Lubrication	Not required (Use turbine oil Class 1 (ISO VG32), if lubricated.)
	Temperature	-5 to 50°C*

* No freezing

How to Order Pilot Valves

0.35 W Type

Pilot Solenoid Valve Specifications

Pilot solenoid valve		V116-□□□-1	
Electrical entry		Conduit terminal, DIN terminal, M12 connector	
Coil rated voltage [V]	DC	12 V, 24 V	
	AC (50/60 Hz)	100 V, 110 V, 200 V, 220 V	
Allowable voltage fluctuation		±10% of rated voltage*	
Power consumption [W]	DC	0.35 W (With indicator light: 0.58 W)	
Apparent power [VA]	AC	100 V	0.78 (With indicator light: 0.87)
		110 V	0.86 (With indicator light: 0.97)
		[115 V]	[0.94 (With indicator light: 1.07)]
		200 V	1.15 (With indicator light: 1.30)
		[230 V]	[1.27 (With indicator light: 1.46)]
Surge voltage suppressor		Varistor	
Indicator light		LED (Neon bulb: AC voltage with DIN terminal, M12 connector)	
Enclosure		IEC60529 standard IP65, JIS C0920	

* In common between 110 VAC and 115 VAC, and between 220 VAC and 230 VAC.
* For 115 VAC and 230 VAC, the allowable voltage fluctuation is -15% to +5% of rated voltage.

V116-**5**T**Z**-1



① Rated voltage

1	100 VAC 50/60 Hz
2	200 VAC 50/60 Hz
3	110 VAC [115 VAC] 50/60 Hz
4	220 VAC [230 VAC] 50/60 Hz
5	24 VDC
6	12 VDC

② Electrical entry

T	Conduit terminal
D	DIN terminal (with connector)
DO	DIN terminal (without connector)
W	M12 connector (4-pin type)
V	M12 connector (5-pin type) ^{Note)}

Note) Only DC voltage is available.

③ Light/surge voltage suppressor

Nil	None
S	With surge voltage suppressor
Z	With light/surge voltage suppressor

Note) Refer to the table (1) on page 580 for combinations with electrical entry.

* DOS, DOZ are not available.

* For AC voltage, only DO is available for Nil.

1.8 W Type

Pilot Solenoid Valve Specifications

Pilot solenoid valve		VO307(Y)-□□□1-Q	
Electrical entry		DIN terminal, M12 connector	
Coil rated voltage [V]	DC	12 V, 24 V	
	AC (50/60 Hz)	100 V, 110 V, 200 V, 220 V	
Allowable voltage fluctuation		-15% to 10% of rated voltage	
Power consumption [W]	DC	1.8 W (With indicator light: 2 W)	
Apparent power [VA]	AC	Inrush	12.7 VA (50 Hz), 10.7 VA (60 Hz)
		Holding	7.6 VA (50 Hz), 5.4 VA (60 Hz)
Light/surge voltage suppressor	DC	Diode, LED	
Enclosure		Dustproof	

Electrical entry: DIN terminal

VO307**Y**-**5**^D**Z**1-Q



Electrical entry: M12 connector

VO307**Y**-**5****D****Z**1-**W**-X352-Q



① Voltage

Nil	AC
Y	DC

② Rated voltage

1	100 VAC 50/60 Hz
2	200 VAC 50/60 Hz
3	110 VAC 50/60 Hz
4	220 VAC 50/60 Hz
5	24 VDC
6	12 VDC

③ Light/surge voltage suppressor

Nil	None
Z	With light/surge voltage suppressor

Note) Refer to the table (1) on page 580 for combinations with electrical entry.

④ Electrical entry

W	M12 connector (4-pin type)
V	M12 connector (5-pin type) ^{Note)}

Note) Only DC voltage is available.

Construction

SGC2, 3, 4, 5 series

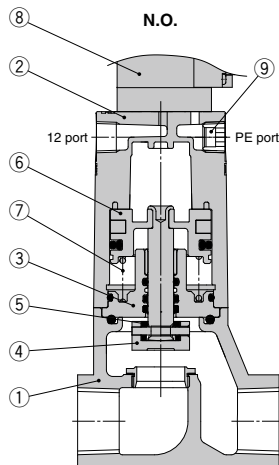
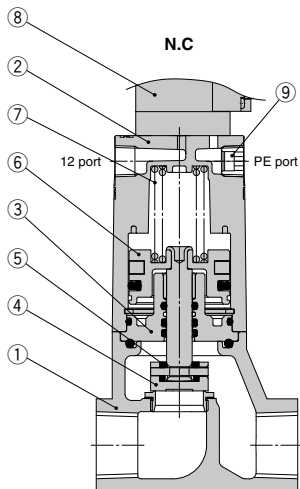

SGC6, 7 series

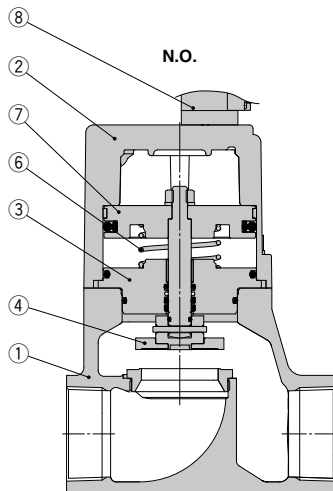
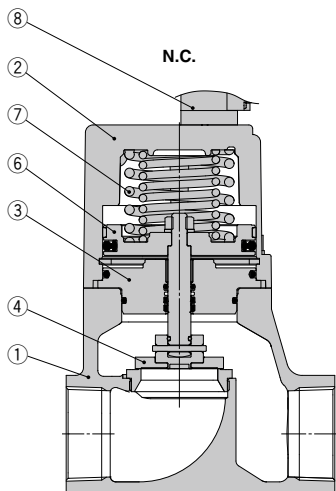

Component Parts

No.	Description	Material	Note
1	Body assembly	Cast iron	Plated
2	Cover assembly	Aluminum die-casted	White
3	Plate assembly	Iron	Seal material (NBR, FKM), Plated
4	Valve body	Stainless steel	
5	Valve cover	NBR, FKM	
6	Piston assembly	Stainless steel, Aluminum	
7	Return spring	Stainless steel, Piano wire	
8	Pilot solenoid valve	—	
9	Filter	Copper	

VNA
VNB
SGC
SGH
VNC
VNH
VND
VCC
TQ

SGC Series

Dimensions

Air operated

SGC2, 3, 4 series

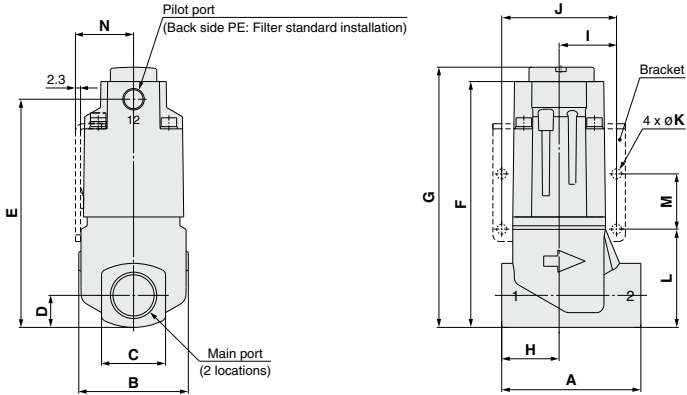

Model	Main port	Pilot port	A	B	C	D	E	F	G	H	I	J	K	L	M	N
SGCA22□□-□□10	3/8	1/8	63	49.6	29	14.5	103.3	111.3	117.8	26	26	52	4.5	44.5	25	26.3
SGCA22□□-□□15	1/2	1/8	63	49.6	29	14.5	103.3	111.3	117.8	26	26	52	4.5	44.5	25	26.3
SGCA32□□-□□20	3/4	1/8	80	59	35	17.5	112	120.5	127	35	31	62	5.5	48	30	31
SGCA42□□-□□25	1	1/8	90	74	44	22	135.9	144.5	151	40	36	72	6.5	60	35	39.5

SGC5, 6, 7 series

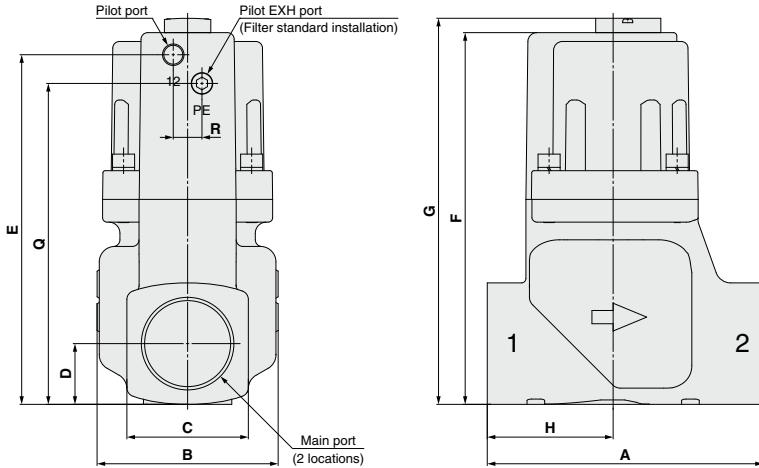

Model	Main port	Pilot port	A	B	C	D	E	F	G	H	Q	R
SGCA52□□-□□32	1 1/4	1/8	125	82	55	27.5	158.3	168.3	174.8	57	145.3	13
SGCA62□□-□□40	1 1/2	1/4	140	98	61	30.5	179.5	191.5	198	59	163.5	19
SGCA72□□-□□50	2	1/4	160	115	74	37	206	218	224.5	71	190	19

Dimensions

External pilot solenoid: 0.35 W type (Pilot valve V116)

(Conduit terminal)

SGC2, 3, 4 series

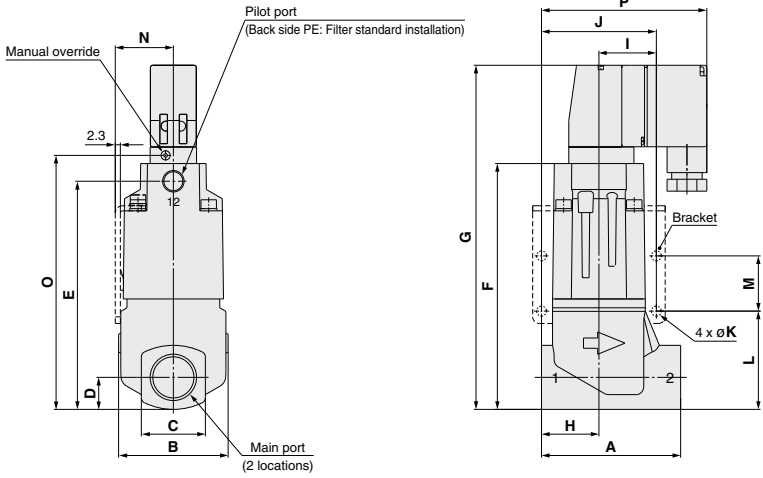

Model	Main port	Pilot port	A	B	C	D	E	F	G	H	I	J	K	L	M	N	O	P
SGC22 □□-□□ 10	3/8	1/8	63	49.6	29	14.5	103.3	111.3	155.8	26	26	52	4.5	44.5	25	26.3	115	74.2
SGC22 □□-□□ 15	1/2	1/8	63	49.6	29	14.5	103.3	111.3	155.8	26	26	52	4.5	44.5	25	26.3	115	74.2
SGC32 □□-□□ 20	3/4	1/8	80	59	35	17.5	112	120.5	165	35	31	62	5.5	48	30	31	124.2	80.1
SGC42 □□-□□ 25	1	1/8	90	74	44	22	135.9	144.5	189	40	36	72	6.5	60	35	39.5	148.2	91.1

SGC5, 6, 7 series

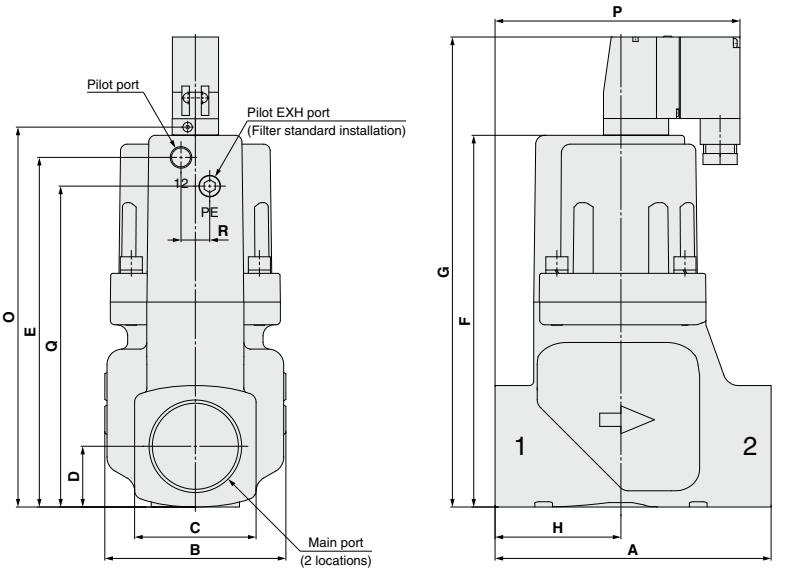

Model	Main port	Pilot port	A	B	C	D	E	F	G	H	O	P	Q	R
SGC52 □□-□□ 32	1 1/4	1/8	125	82	55	27.5	158.3	168.3	212.8	57	172	110.9	145.3	13
SGC62 □□-□□ 40	1 1/2	1/4	140	98	61	30.5	179.5	191.5	236	59	195.2	121.6	163.5	19
SGC72 □□-□□ 50	2	1/4	160	115	74	37	206	218	262.5	71	221.7	143.6	190	19

- VNA
- VNB
- SGC**
- SGH
- VNC
- VNH
- VND
- VCC
- TQ

Dimensions

External pilot solenoid: 0.35 W type (Pilot valve V116)
(DIN terminal, M12 connector)

SGC2, 3, 4 series

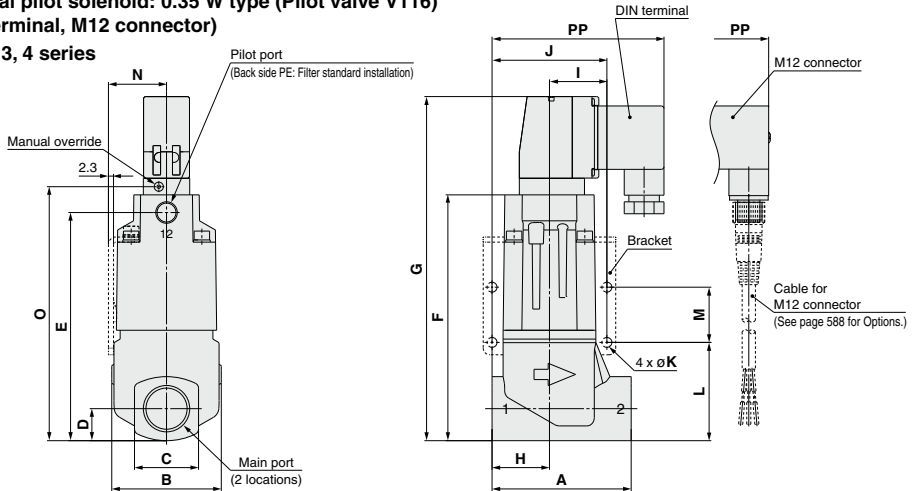

Model	Main port	Pilot port	A	B	C	D	E	F	G	H	I	J	K	L	M	N	O	PP
SGC22□□-□□10	3/8	1/8	63	49.6	29	14.5	103.3	111.3	155.8	26	26	52	4.5	44.5	25	26.3	115	79.9
SGC22□□-□□15	1/2	1/8	63	49.6	29	14.5	103.3	111.3	155.8	26	26	52	4.5	44.5	25	26.3	115	79.9
SGC32□□-□□20	3/4	1/8	80	59	35	17.5	112	120.5	165	35	31	62	5.5	48	30	31	124.2	85.8
SGC42□□-□□25	1	1/8	90	74	44	22	135.9	144.5	189	40	36	72	6.5	60	35	39.5	148.2	96.8

SGC5, 6, 7 series

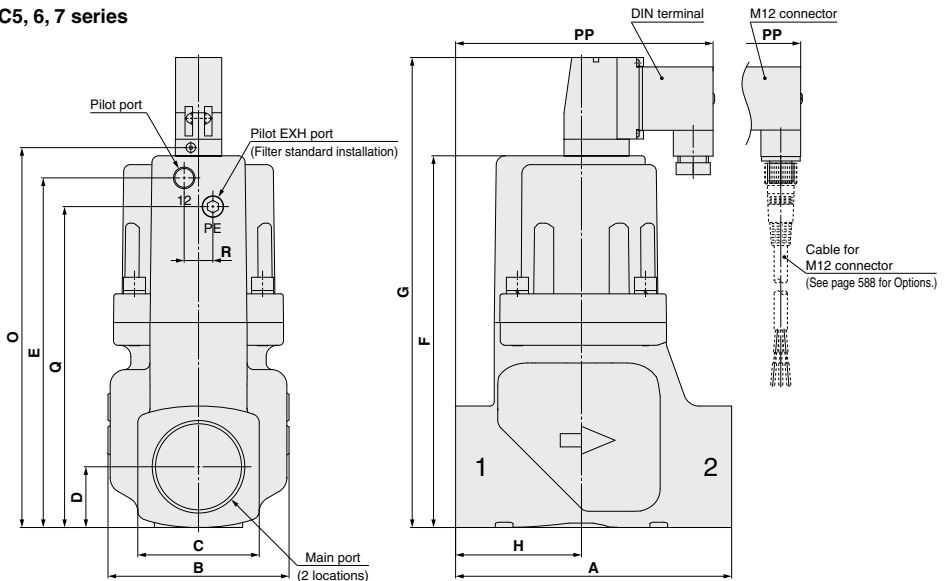

Model	Main port	Pilot port	A	B	C	D	E	F	G	H	O	PP	Q	R
SGC52□□-□□32	1 1/4	1/8	125	82	55	27.5	158.3	168.3	212.8	57	172	116.6	145.3	13
SGC62□□-□□40	1 1/2	1/4	140	98	61	30.5	179.5	191.5	236	59	195.2	127.3	163.5	19
SGC72□□-□□50	2	1/4	160	115	74	37	206	218	262.5	71	221.7	149.3	190	19

Dimensions

External pilot solenoid: 1.8 W type (Pilot valve VO307)

(DIN terminal, M12 connector)

SGC5, 6, 7 series

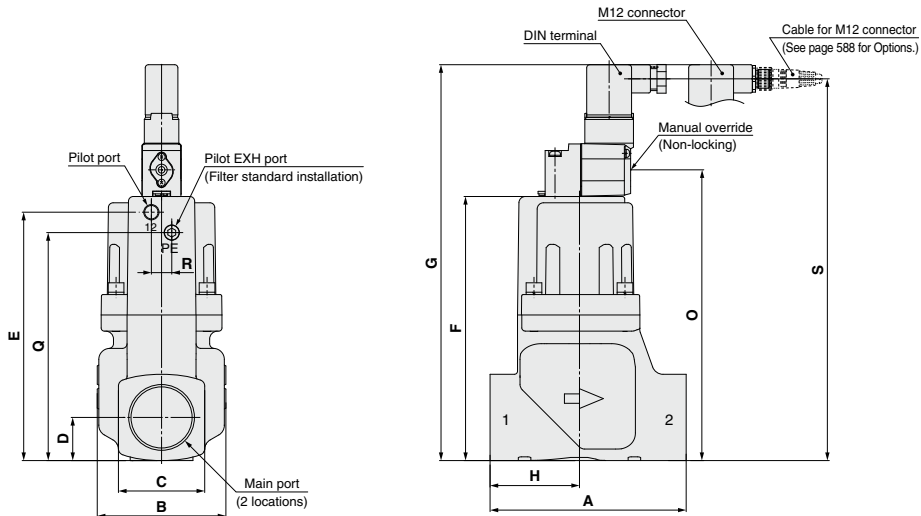

Model	Main port	Pilot port	A	B	C	D	E	F	G	H	O	Q	R	S
SGC52□□-□□32H	1 1/4	1/8	125	82	55	27.5	158.3	168.3	252.3	57	185.3	145.3	13	243.3
SGC62□□-□□40H	1 1/2	1/4	140	98	61	30.5	179.5	191.5	275.5	59	208.5	163.5	19	266.5
SGC72□□-□□50H	2	1/4	160	115	74	37	206	218	302	71	235	190	19	293

- VNA
- VNB
- SGC**
- SGH
- VNC
- VNH
- VND
- VCC
- TQ

SGC Series

How to Fix an Auto Switch

SGC2, 3, 4 series

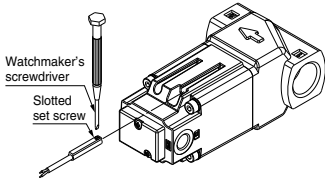

When tightening an auto switch mounting screw, use a watchmaker's screwdriver with a handle of approximately 5 to 6 mm in diameter. Also, tighten with a torque of about 0.05 to 0.15 N·m, or about 0.05 to 0.10 N·m for D-M9□.

Auto Switch Proper Mounting Position

SGC2, 3, 4 series

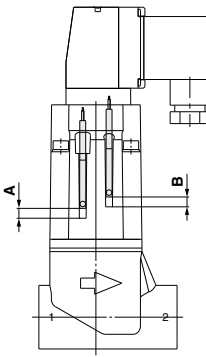

[mm]

Model	D-M9□	
SGC(A)2□□□-05□10, 15	A	5
	B	5
SGC(A)2□□□-10□10, 15	A	6
	B	5
SGC(A)2□□□-16□10, 15	A	7
	B	5
SGC(A)3□□□-05□20	A	4
	B	4
SGC(A)3□□□-10□20	A	6
	B	4
SGC(A)3□□□-16□20	A	7
	B	4
SGC(A)4□□□-05□25	A	3
	B	3
SGC(A)4□□□-10□25	A	6
	B	3
SGC(A)4□□□-16□25	A	7
	B	3

* The above dimensions including a mounted auto switch are for reference only. Confirm that the auto switch works appropriately.

Options

Cable for M12 connector (Female connector with cable)

V100-200-1-4

Specifications

4-pin type	1	For DC
	2	For AC
5-pin type	3	For DC

* When selecting the 5-pin type, only DC voltage is available.

Cable length [L]

4	1000 [mm]
8	3000 [mm]
9	5000 [mm]

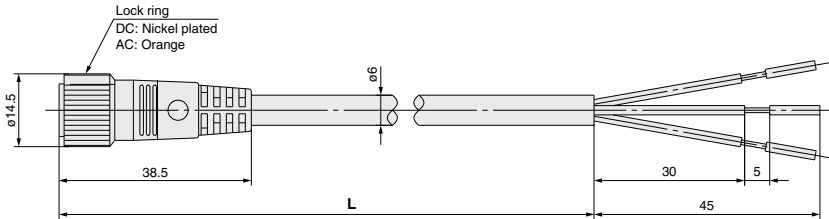

4-pin type

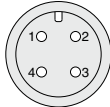

Socket pin connector pin arrangement

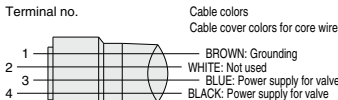

Connections

5-pin type

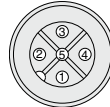

Socket pin connector pin arrangement

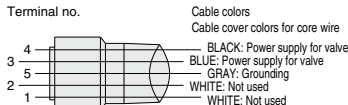

Connections

How to Order

Include the part number of the female connector with cable together with the part number for the solenoid valve.
Example) For lead wire length, 1000 mm

For DC
SGC221A-0510Y-5WZ
V100-200-1-4

For AC
SGC221A-0510Y-1WZ
V100-200-2-4

Note) For the valve polarity, refer to "Pin assignment of M12 connector on valve side" on page 594.

Solid State Auto Switch Direct Mounting Type D-M9N/D-M9P/D-M9B



Grommet

- 2-wire load current is reduced (2.5 to 40 mA).
- Using flexible cable as standard.



Caution

Precautions

Fix the auto switch with the existing screw installed on the auto switch body. The auto switch may be damaged if a screw other than the one supplied is used.

Caution

Prior to Use

For details about "Auto Switch Connection and Example", refer to "Handling Precautions for SMC Products" on SMC website.

Lead Wire Length

Lead wire length indication

(Example)



● Lead wire length

Nil	0.5 m
M	1 m
L	3 m
Z (Note)	5 m

Note) Lead wire length of 5 m (Z) is manufactured upon receipt of order as standard for all applicable auto switches.

Auto Switch Specifications

Refer to SMC website for the details about products conforming to the international standards.

PLC: Programmable Logic Controller

D-M9□ (With indicator light)			
Auto switch model	D-M9N	D-M9P	D-M9B
Electrical entry	In-line	In-line	In-line
Wiring type	3-wire		2-wire
Output type	NPN	PNP	—
Applicable load	IC circuit, Relay, PLC		24 VDC relay, PLC
Power supply voltage	5, 12, 24 VDC (4.5 to 28 V)		—
Current consumption	10 mA or less		—
Load voltage	28 VDC or less	—	24 VDC (10 to 28 VDC)
Load current	40 mA or less		2.5 to 40 mA
Internal voltage drop	0.8 V or less at 10 mA (2 V or less at 40 mA)		4 V or less
Leakage current	100 μA or less at 24 VDC		0.8 mA or less
Indicator light	Red LED lights up when turned ON.		
Standards	CE/UKCA marking, RoHS		

Oilproof Flexible Heavy-duty Lead Wire Specifications

Auto switch model		D-M9N	D-M9P	D-M9B
Sheath	Outside diameter [mm]	2.6		
Insulator	Number of cores	3 cores (Brown/Blue/Black)		2 cores (Brown/Blue)
	Outside diameter [mm]	0.88		
Conductor	Effective area [mm ²]	0.15		
	Strand diameter [mm]	0.05		
Minimum bending radius [mm] (Reference value)				17

Note 1) Refer to the Best Pneumatics No.2-1 catalog for solid state auto switch common specifications.

Note 2) Refer to the Best Pneumatics No.2-1 catalog for lead wire lengths.

Weight

[g]

Auto switch model		D-M9N	D-M9P	D-M9B
Lead wire length	0.5 m (Nil)	8	7	7
	1 m (M)	14	13	13
	3 m (L)	41	38	38
	5 m (Z)	68	63	63

Dimensions

[mm]

D-M9□

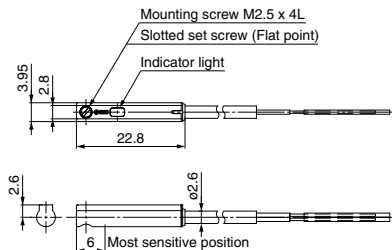

VNA

VNB

SGC

SGH

VNC

VNH

VND

VCC

TQ

Water Resistant 2-Color Indication Solid State Auto Switch: Direct Mounting Type D-M9NA/D-M9PA/D-M9BA



Grommet

- Water (coolant) resistant type
- 2-wire load current is reduced (2.5 to 40 mA).
- The optimum operating position can be determined by the color of the light. (Red → Green ← Red)
- Using flexible cable as standard.



Caution

Precautions

Fix the auto switch with the existing screw installed on the auto switch body. The auto switch may be damaged if a screw other than the one supplied is used. Please consult with SMC if using coolant liquid other than water based solution.

Caution

Prior to Use

For details about "Auto Switch Connection and Example", refer to "Handling Precautions for SMC Products" on SMC website.

Lead Wire Length

Lead wire length indication

(Example)

D-M9 A L

● Lead wire length

Nil	0.5 m
M ^{Note 2)}	1 m
L	3 m
Z ^{Note 1)}	5 m

Note 1) Lead wire length of 5 m (Z) is manufactured upon receipt of order as standard for all applicable auto switches.

Note 2) Lead wire length of 1 m (M) is only available for the D-M9□. For the D-M9□A, it will be made upon request.

Auto Switch Specifications

PLC: Programmable Logic Controller

D-M9□A (With indicator light)			
Auto switch model	D-M9NA	D-M9PA	D-M9BA
Electrical entry	In-line	In-line	In-line
Wiring type	3-wire		2-wire
Output type	NPN	PNP	—
Applicable load	IC circuit, Relay, PLC		24 VDC relay, PLC
Power supply voltage	5, 12, 24 VDC (4.5 to 28 V)		—
Current consumption	10 mA or less		—
Load voltage	28 VDC or less	—	24 VDC (10 to 28 VDC)
Load current	40 mA or less		2.5 to 40 mA
Internal voltage drop	0.8 V or less at 10 mA (2 V or less at 40 mA)		4 V or less
Leakage current	100 μA or less at 24 VDC		0.8 mA or less
Indicator light	Operating position Red LED lights up. Optimum operating position Green LED lights up.		
Standards	CE/UKCA marking, RoHS		

Oilproof Flexible Heavy-duty Lead Wire Specifications

Auto switch model		D-M9NA	D-M9PA	D-M9BA
Sheath	Outside diameter [mm]	2.6		
Insulator	Number of cores	3 cores (Brown/Blue/Black)		2 cores (Brown/Blue)
	Outside diameter [mm]	0.88		
Conductor	Effective area [mm ²]	0.15		
	Strand diameter [mm]	0.05		
Minimum bending radius [mm] (Reference value)		17		

Note 1) Refer to the Best Pneumatics No.2-1 catalog for solid state auto switch common specifications.

Note 2) Refer to the Best Pneumatics No.2-1 catalog for lead wire lengths.

Weight

[g]

Auto switch model		D-M9NA	D-M9PA	D-M9BA
Lead wire length	0.5 m (Nil)	8	7	7
	1 m (M)	14	13	13
	3 m (L)	41	38	38
	5 m (Z)	68	63	63

Dimensions

[mm]

D-M9□A

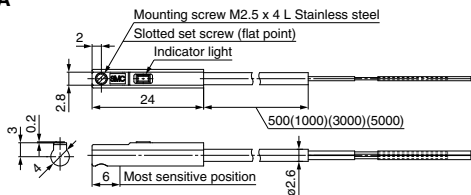



1 Pilot Valve: SF4

Symbol
-X1

Power consumption: 1.8 W

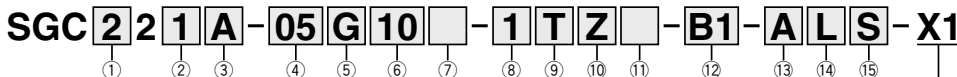

⑦ Pilot valve

Nil	SF4
-----	-----

⑧ Rated voltage

1	100 VAC 50/60 Hz
2	200 VAC 50/60 Hz
3	110 VAC 50/60 Hz
4	220 VAC 50/60 Hz
5	24 VDC
6	12 VDC
7	240 VAC 50/60 Hz
9	Others

⑪ Manual override

Nil	Push type
B	Slotted locking type

Pilot valve: SF4

Equivalent to the standard models except for ⑦, ⑧, ⑨, ⑩, ⑪. See pages 580 and 581.

Refer to Table (1) below for details on ⑨ Electrical entry and ⑩ Light/surge voltage suppressor combinations.

Pilot Solenoid Valve Specifications

Pilot solenoid valve		SF4-□□□-50-X240	
Electrical entry		Conduit terminal, DIN terminal, M12 connector	
Coil rated voltage [V]	DC	24 V, Other (Option)	
	AC (50/60 Hz)	100 V, 200 V, Other (Option)	
Allowable voltage fluctuation		-15 to 10% of rated voltage	
Power consumption [W]	DC	1.8 W (With indicator light: 2 W)	
Apparent power [VA]	AC	Inrush	5.6 VA (50 Hz) 5.0 VA (60 Hz)
		Holding	3.4 VA (50 Hz) 2.3 VA (60 Hz)
Light/surge voltage suppressor	DC	ZNR (Varistor), LED (Neon bulb for 100 V or more)	
	AC	ZNR (Varistor), Neon bulb (LED for less than 100 V)	

How to Order Pilot Valve

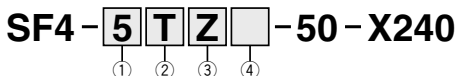

① Rated voltage

1	100 VAC 50/60 Hz
2	200 VAC 50/60 Hz
3	110 VAC 50/60 Hz
4	220 VAC 50/60 Hz
5	24 VDC
6	12 VDC
7	240 VAC 50/60 Hz
9	Others

② Electrical entry

T	Conduit terminal
D	DIN terminal (with connector)
DO	DIN terminal (without connector)
W	M12 connector (4-pin type)
V	M12 connector (5-pin type) <small>Note2)</small>

Note1) Refer to the table (1) below for combinations with light/surge voltage suppressors.

Note2) Only DC voltage is available.

③ Light/surge voltage suppressor

Nil	None
S	With surge voltage suppressor
Z	With light/surge voltage suppressor

④ Manual override

Nil	Push type
B	Slotted locking type

* Refer to Table (1) below for combinations with electrical entry.

Table (1) Electrical Entry/Light/Surge Voltage Suppressor

Rated voltage	Electrical entry	Without light/surge voltage suppressor	With surge voltage suppressor	With light/surge voltage suppressor
		Nil	S	Z
AC	T	—	—	●
	D	—	●	●
	DO			
DC	T	●	—	●
	D	●	●	●
	W, V	●	—	—
	DO			

VNA

VNB

SGC

SGH

VNC

VNH

VND

VCC

TQ



1 Pilot Valve: SF4

Symbol
-X1

Dimensions

Equivalent to the standard models except the dimensions given in the diagram.

Conduit terminal

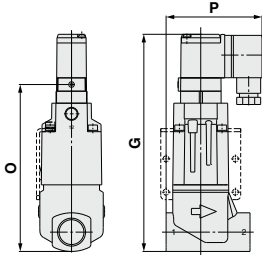

Model	Main port	G	O	P
SGC2 □□□-□□ 10	3/8	163	125.3	72.8
SGC2 □□□-□□ 15	1/2	163	125.3	72.8
SGC3 □□□-□□ 20	3/4	172.2	134.5	78.7
SGC4 □□□-□□ 25	1	196.2	158.5	89.7

DIN terminal

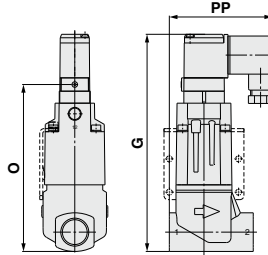

Model	Main port	G	O	PP
SGC2 □□□-□□ 10	3/8	163	125.3	79.1
SGC2 □□□-□□ 15	1/2	163	125.3	79.1
SGC3 □□□-□□ 20	3/4	172.2	134.5	85
SGC4 □□□-□□ 25	1	196.2	158.5	96

M12 connector

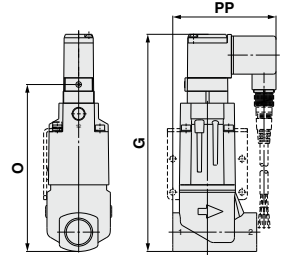

Model	Main port	G	O	PP
SGC2 □□□-□□ 10	3/8	163	125.3	79.1
SGC2 □□□-□□ 15	1/2	163	125.3	79.1
SGC3 □□□-□□ 20	3/4	172.2	134.5	85
SGC4 □□□-□□ 25	1	196.2	158.5	96



SGC Series

Specific Product Precautions 1

Be sure to read this before handling the products.

Refer to back page 50 for Safety Instructions and pages 17 to 19 for 2 Port Solenoid Valve for Fluid Control Precautions.

Design

⚠ Warning

Extended periods of continuous energization

If a valve is continuously energized for long periods, heat generation of the coil may result in reduced performance and shorter service life. This may also have an adverse effect on the peripheral equipment in proximity. Should a valve be continuously energized for long periods, or its daily energized state exceeds its non energized state, please use an energy saving type valve with DC voltage. Additionally, when using with AC voltage, energizing for long periods of time continuously, select the air-operated valve and use the continuous duty type of the VT307 for a pilot valve.

Fluid Quality

⚠ Warning

Although the product has a scraper to prevent foreign matter from entering into the product, fluid containing fine foreign matter such as abrasive powder may cause sealing failure by the foreign matter adhering to the rod sliding part. Perform periodic maintenance or take countermeasures. Sealing failure of the rod sliding surface will allow reverse flow of the fluid in the pilot air piping, entering into the pilot valve or circuit connected to the pilot air piping, causing adverse effects such as operation failure or leakage.

Mounting

⚠ Warning

- Do not apply external force to the coil section.**
When tightening is performed, apply a wrench or other tool to the outside of the piping connection parts.
- Do not warm the coil assembly with a heat insulator etc.**
Use tape, heaters, etc., for freeze prevention on the piping and body only. They can cause the coil to burn out.
- Avoid sources of vibration, or adjust the arm from the body to the minimum length so that resonance will not occur.**
- When mounted in the vertical downward direction, foreign matter can remain in the plate assembly part if there is foreign matter in the coolant. For this reason, avoid mounting in the vertical downward direction as much as possible.**

Manual Override

⚠ Warning

Since connected equipment will be actuated when the manual override is operated, first confirm that conditions are safe.

■ Non-locking push type

Press in the direction of the arrow.



■ Push-turn

locking slotted type [D type]

While pressing, turn in the direction of the arrow (90° clockwise). If it is not turned, it can be operated the same way as the non-locking type.

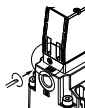

Manual Override

⚠ Caution

When operating the locking type D with a screwdriver, turn it gently using a flat blade watchmaker's screwdriver. [Torque: Less than 0.1 N·m]

When locking the manual override on the push-turn locking type (D), be sure to push it down before turning. Turning without first pushing it down can cause damage to the manual override and trouble such as air leakage etc.

Wiring

⚠ Caution

1. Applied voltage

When electric power is connected to a solenoid valve, be careful to apply the proper voltage. Improper voltage may cause a malfunction or coil damage.

2. Check the connections.

After completing the wiring, confirm that the connections are correct.

Leakage Voltage

⚠ Caution

Take note that the leakage voltage will increase when a resistor is used in parallel with switching element or a C-R circuit (surge voltage suppressor) is used for protecting a switching element because of the passing leakage voltage through the C-R circuit. The suppressor residual leakage voltage should be as follows.

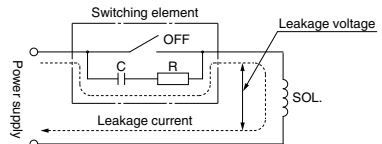

DC coil

3% or less of rated voltage.

AC coil

8% or less of rated voltage. (For 0.35 W type: Pilot valve V116)
15% or less of rated voltage. (For 1.8 W type: Pilot valve VO307)

Operating Environment

⚠ Caution

- Products with IP65 enclosures (based on IEC60529) are protected against dust and water, however, these products cannot be used in water.
- If the product is used in an environment where condensation is generated, there may be a risk of rusting.

Maintenance

⚠ Warning

Do not disassemble the product. Products which have been disassembled cannot be guaranteed. Especially, do not remove the type C retaining ring in the cover of NC valve. Piston or spring will jump out and might cause injury.



SGC Series

Specific Product Precautions 2

Be sure to read this before handling the products.

Refer to back page 50 for Safety Instructions and pages 17 to 19 for 2 Port Solenoid Valve for Fluid Control Precautions.

Precautions on 0.35 W Type [Pilot Valve V116]

Light/Surge Voltage Suppressor

⚠ Caution

<For DC>

Conduit terminal (Non-polar type)

With surge voltage suppressor (TS)

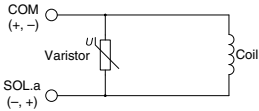

With light/surge voltage suppressor (TZ)

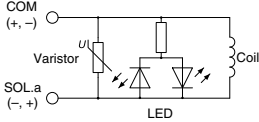

DIN terminal (Non-polar type)

With surge voltage suppressor (DS)

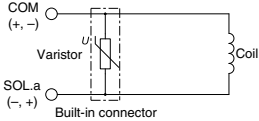

With light/surge voltage suppressor (DZ)

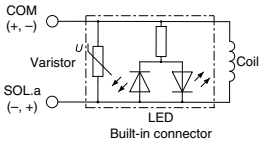

M12 connector (Non-polar type)

With surge voltage suppressor (WS/VS)

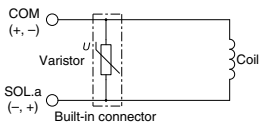

With light/surge voltage suppressor (WZ/VZ)

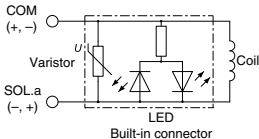

<For AC>

Conduit terminal

With surge voltage suppressor (TS)

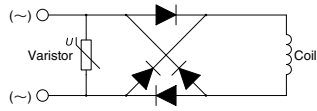

With light/surge voltage suppressor (TZ)

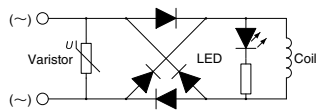

DIN terminal

With surge voltage suppressor (DS)

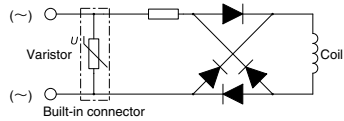

With light/surge voltage suppressor (DZ)

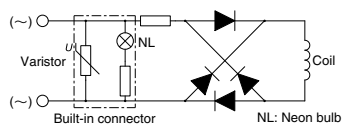

M12 connector

With surge voltage suppressor (WS)

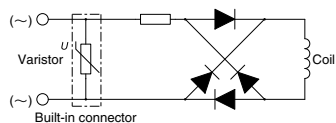

With light/surge voltage suppressor (WZ)

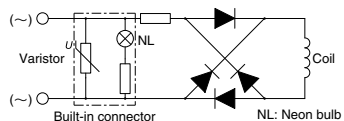

VNA

VNB

SGC

SGH

VNC

VNH

VND

VCC

TQ



SGC Series

Specific Product Precautions 3

Be sure to read this before handling the products.

Refer to back page 50 for Safety Instructions and pages 17 to 19 for 2 Port Solenoid Valve for Fluid Control Precautions.

M12 Connector

⚠ Caution

1. M12 connector types of the pilot valve V116 have an IP65 (enclosure) rating, offering protection from dust and water. However please note: these products are not intended for use in water.
2. Do not use a tool to mount the connector, as this may cause damage. Only tighten by hand. (0.4 to 0.6 N·m)
3. The excessive stress on the cable connector will not be able to satisfy the IP65 rating. Please use caution and do not apply a stress of 30 N or greater.

Please note that if a connector other than the one stated above is used or if the connector is not tightened enough, the IP65 standards will not be satisfied.

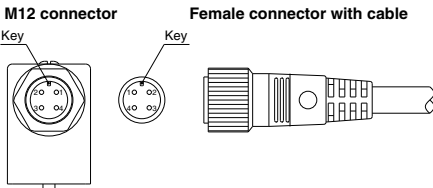

Note) For connecting a female connector with cable, adjust the connector key to the M12 connector key in the valve side since there is an orientation.

Be careful not to squeeze it in the wrong direction, as problems such as pin damage may occur.

■ Pin assignment of M12 connector on valve side

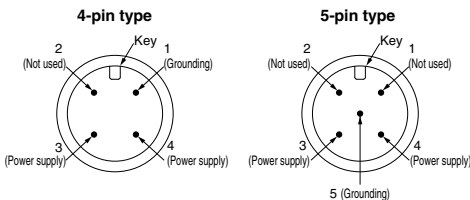

Note) About DC specifications

0.35 W type (Pilot valve V116) has no polarity.

1.8 W type (Pilot valve V0307) has the polarity, pin no. 3 (-) and pin no. 4 (+).

How to Use Conduit Terminal

⚠ Caution

Connection

1. Loosen the holding screw and remove the cover from the terminal block.
2. Loosen the screw in the terminal block. Insert the lead core wires or crimped terminals to the terminals, and secure the wires by re-tightening the terminal screw.
3. Secure the cord by fastening the ground nut.

When making connections, please note that using other than the supported size ($\phi 4.5$ to $\phi 7$) heavy-duty cord will not satisfy IP65 (enclosure) standards. Also, be sure to tighten the ground nut and holding screw within their specified torque ranges.

Compatible cable

Cord O.D.: $\phi 4.5$ to $\phi 7$

(Reference) 0.5 to 1.5 mm², 2-core or 3-core, equivalent to JIS C 3306

Applicable crimped terminals

O-terminals: Equivalent to R1.25-3 defined in the JIS C2805

Y-terminals: Equivalent to 1.25-3 manufactured by J.S.T. Mfg. Co., Ltd.

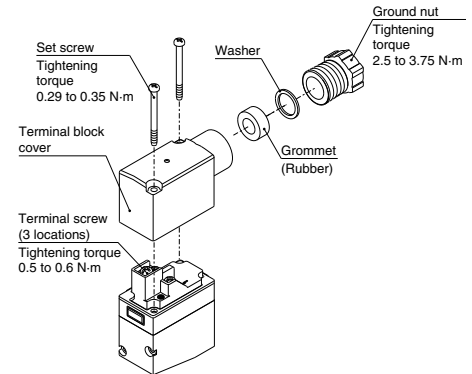



SGC Series

Specific Product Precautions 4

Be sure to read this before handling the products.

Refer to back page 50 for Safety Instructions and pages 17 to 19 for 2 Port Solenoid Valve for Fluid Control Precautions.

Precautions on 0.35 W Type [Pilot Valve V116]

How to Use DIN Terminal

⚠ Caution

Connection

1. Loosen the holding screw and pull the connector out of the solenoid valve terminal block.
2. After removing the holding screw, insert a flat blade screwdriver, etc. into the notch on the bottom of the terminal block and pry it open, separating the terminal block and the housing.
3. Loosen the screw (slotted screws) in the terminal block. Insert the lead core wires or crimped terminals to the terminals according to the connection method, and secure the wires by re-tightening the terminal screw.
4. Secure the cord by fastening the ground nut.

When making connections, please note that using other than the supported size ($\phi 4.5$ to $\phi 7$) heavy-duty cord will not satisfy IP65 (enclosure) standards. Also, be sure to tighten the ground nut and holding screw within their specified torque ranges.

Changing the entry direction

After separating the terminal block and housing, the cord entry can be changed by attaching the housing in the opposite direction 180° .

* Be careful not to damage the element etc. with the cord's lead wires.

Plug in and pull out the connector vertically without tilting to one side.

Compatible cable

Cord O.D.: $\phi 4.5$ to $\phi 7$

(Reference) 0.5 to 1.5 mm², 2-core or 3-core, equivalent to JIS C 3306

Applicable crimped terminals

O-terminals: Equivalent to R1.25-4M defined in the JIS C2805

Y-terminals: Equivalent to 1.25-3L manufactured by J.S.T. Mfg. Co., Ltd.

Rod-terminals: Up to size 1.5

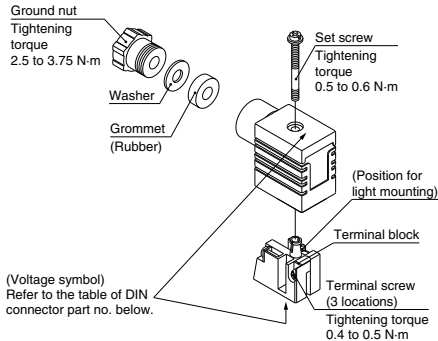

⚠ Caution

DIN Connector Part No.

Without light	Only DC voltage	V100-61-1
---------------	-----------------	-----------

With Surge Voltage Suppressor

Rated voltage	Voltage symbol	Part no.
24 VDC	DC 24 VS	V100-61-5-05
12 VDC	DC 12 VS	V100-61-5-06
100 VAC	100/110 VS	V100-61-4-01
200 VAC	200/220 VS	V100-61-4-02
110 VAC	100/110 VS	V100-61-4-01
220 VAC	200/220 VS	V100-61-4-02
240 VAC	240 VS	V100-61-4-07

With Light/Surge Voltage Suppressor

Rated voltage	Voltage symbol	Part no.
24 VDC	DC 24 VZ	V100-61-3-05
12 VDC	DC 12 VZ	V100-61-3-06
100 VAC	100/110 VZ	V100-61-2-01
200 VAC	200/220 VZ	V100-61-2-02
110 VAC	100/110 VZ	V100-61-2-01
220 VAC	200/220 VZ	V100-61-2-02
240 VAC	240 VZ	V100-61-2-07

When AC voltage without DIN terminal (DO) is selected, always use a DIN connector with surge voltage suppressor as the connector.

Pitch between terminals of the DIN terminal

Refer to the drawing below for the pitch between terminals of the DIN terminal.

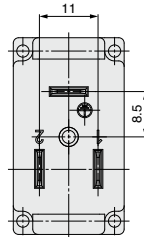

VNA

VNB

SGC

SGH

VNC

VNH

VND

VCC

TQ



SGC Series

Specific Product Precautions 5

Be sure to read this before handling the products.

Refer to back page 50 for Safety Instructions and pages 17 to 19 for 2 Port Solenoid Valve for Fluid Control Precautions.

Precautions on 0.35 W Type [Pilot Valve V116]

Circuit Diagram with Light/Surge Voltage Suppressor

AC circuit diagram

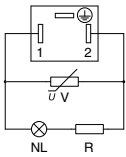

NL: Neon bulb, R: Resistor
V: Varistor

DC circuit diagram

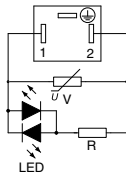

LED: Emitting diode, R: Resistor
V: Varistor

Response

Caution

Pilot valve V116 is a low power consumption type. The response is slower than the VNC series. If the response time is a problem, use products below.

SGC200/300/400: Made to Order (Part number suffix "-X1")
See page 591.

SGC500/600/700: Installed pilot valve VO307 (1.8 W type)
See page 580.

Precautions on 1.8 W Type [Pilot Valve VO307]

How to Use DIN Terminal

Disassembly

- 1) Loosen screw ① and pull up housing ② in the direction of screw ① to remove the connector from the body (solenoid).
- 2) Pull out screw ① from housing ②.
- 3) On the bottom part of terminal block ③, there is a notch ⑨. If a small flat blade screwdriver is inserted into the gap between housing ② and terminal block ③, terminal block ③ will be removed from housing ②. (Refer to the figure below.)
- 4) Remove cable gland ④, washer ⑤ and rubber seal ⑥.

Wiring

- 1) Insert cable gland ④, washer ⑤ and rubber seal ⑥ into cable ⑦ in order, and insert it into housing ②.
- 2) Loosen screws ⑪ on terminal block ③. Insert lead wires ⑩ and tighten screws ⑪ again.

Note 1) The tightening torque should be 0.5 N·m ±15%.

Note 2) The applicable outside diameter of cable ⑦ is $\phi 6$ to $\phi 8$ mm.

Note 3) Round or Y-shaped crimped terminal cannot be used.

Assembly

- 1) Insert cable gland ④, washer ⑤ and rubber seal ⑥ and housing ② into cable ⑦ in order. Connect cable ⑦ to terminal block ③ and fix terminal block ③ to housing ② in place. Insert the terminal block until it makes a click sound.
- 2) Insert rubber seal ⑥ and washer ⑤ into the cable entry on housing ② in order, and tighten cable gland ④ securely.
- 3) Insert gasket ⑧ into the gap between the bottom of terminal block ③ and plug on the equipment, and insert screw ① into the top of housing ② to tighten them.

Note 1) The tightening torque should be 0.5 N·m ±20%.

Note 2) The orientation of the connector can be changed by 180 degrees depending on the mounting direction of housing ② and terminal block ③.

DIN Terminal Connector

Description	Part no.
DIN connector	GM209NJ-B17 (CE/UKCA-compliant)

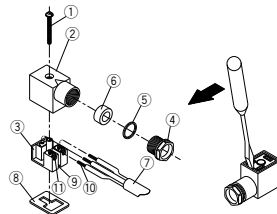



SGC Series

Specific Product Precautions 6

Be sure to read this before handling the products.

Refer to back page 50 for Safety Instructions and pages 17 to 19 for 2 Port Solenoid Valve for Fluid Control Precautions.

Precautions on 1.8 W Type [Pilot Valve VO307]

Light/Surge Voltage Suppressor

Caution

AC

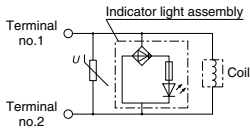

DC

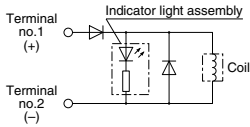

Electrical Wiring

Caution

The DIN connector terminal and conduit terminal (with indicator light/surge voltage suppressor) are wired internally as shown below. Connect each terminal to the corresponding wire of the power supply.

DIN terminal block

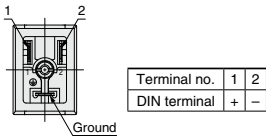

- Applicable cord O.D.
D type: $\phi 6$ to $\phi 8$

Lead Wire Color

Voltage	Color
100 VAC	Blue
200 VAC	Red
DC	Red (+), Black (-)
Other	Gray

Pitch between terminals of the DIN terminal

Refer to the drawing below for the pitch between terminals of the DIN terminal.

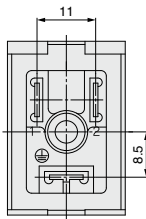

VNA

VNB

SGC

SGH

VNC

VNH

VND

VCC

TQ