

Applicable Auto Switch Variations

Rotary Actuators Applicable Auto Switch Variations

Type	Auto switch mounting type	Electrical entry	Auto switch model	Applicable series											Page								
				Size	30 to 100 CDR A1	10 to 40 CFB	10 to 40 CDRE B2	50 to 100 CDRE B1	10 to 40 CDRO2	05, 1 CRJ	32, 40 MRQ	1, 3 MDSU	7, 20	1 to 7		10 to 50 MSQ	70 to 200	10 to 50 MSZ	10 to 40 CDRO2X	10 to 50 MSQX			
Solid State Auto Switch	Direct	Grommet	D-M9N/M9P/M9B		•	•	•	•	•										937				
			D-M9NV/M9PV/M9BV		•	•	•	•	•											938			
			D-M9N-5/M9P-5/M9B-5																				
			D-F8N/F8P/F8B									•									940		
			D-Y59A/Y7P/Y59B															•			941		
			D-Y69A/Y7P/Y69B																				
			D-S991/S992/D-S99V1/S99V2			•	•							•							942		
			D-T991/T992/D-T99V1/T99V2			•	•								•						942		
			D-S9P1/S9P2/D-S9PV1/S9PV2			•	•								•						942		
			D-S791/S792			•	•	•							•						943		
	D-T791/T792			•	•	•								•					943				
	D-S7P1/S7P2			•	•	•													943				
	D-T791C/T792C	Connector		•	•	•													943				
	D-F79/F7P/J79	Rail	Grommet																	944			
	D-F7NV/F7PV/F7BV																			945			
	D-J79C																				946		
	D-F59/F5P/J59	Tie-rod	Grommet																	947			
	2-color indicator	Direct	Grommet	D-M9NW/M9PW/M9BW		•				•	•					•	•	•	•	•	948		
				D-M9NV/M9PV/M9BV		•																	
				D-Y7NW/Y7PW/Y7BW																			949
		D-Y7NV/Y7PV/Y7BV	Rail	Grommet																	950		
		D-F79W/F7PW/J79W																			951		
2-color indicator with diagnostic output	Rail	Grommet	D-F7NW/F7BW																	952			
			D-F59W/F5PW/J59W																		953		
Water resistant 2-color indicator	Rail	Grommet	D-F79F																	954			
			D-F59F																		955		
			D-M9NA/M9PA/M9BA		•																	956	
With timer	Rail	Grommet	D-M9NA/M9PA/M9BAV																	956			
			D-Y7BA																		957		
			D-F7BA/F7BAV																			958	
Trimmer	Tie-rod	Grommet	D-F5BA																	959			
			D-F7NT																		960		
			D-F5NT																			961	
D-Y7K	Direct	Grommet																	961				
Reed Auto Switch	Direct	Grommet	D-A90/A93/A96		•															973			
			D-A90V/A93V/A96V																			974	
			D-90/97			•	•																975
			D-90A/93A			•	•	•															976
			D-R731/R732			•	•	•	•														976
			D-R801/R802			•	•	•	•														977
			D-R731C/R732C	Connector			•	•	•														977
			D-R801C/R802C				•	•	•														978
	D-A72/A73/A80	Rail	Grommet																			978	
	D-A72H/A73H																						979
	D-A76H/A80H																						980
	D-A73C/A80C			Connector																			981
	D-A53/A54/A56																						982
	D-A64/A67																					982	
D-A79W	Rail	Grommet																			982		
D-A59W	Tie-rod	Grommet																			983		

Air Grippers Applicable Auto Switch Variations

Type	Auto switch mounting type	Electrical entry	Auto switch model	Applicable series																Page													
				8 to 20 JMHZ2	6 MHZ2	10 MHZ (L) 2	16 MHZ (L) 2	20 to 40	6 MHZLJ2	16	20, 25	8 to 20 MHF2	8 to 20 MHF2-□F	10 to 40 MHL2	10 to 30 MDR	12 to 25 MHK (L) 2	16 to 25 MHS	32 to 63 MHSL	80 to 125		16 MHS	20 to 80 MHSJ	6 MHC2	32 to 63 MHT2	20 to 50 MHW2	10 to 25 MHY2	10 to 25 MRHQ						
Solid State Auto Switch	Direct	Grommet	D-M9N/M9P/M9B	●	●	●	●	●	●	●	●	●	●	●	●	●	●	●	●	●	●	●	●	●	●	●	●	●	937				
			D-M9NV/M9PV/M9BV	●	●	●	●	●	●	●	●	●	●	●	●	●	●	●	●	●	●	●	●	●	●	●	●	●	●	●	938		
			D-M9N-5/M9P-5/M9B-5																												938		
			D-F8N/F8P/F8B	●		●	●	●	●	●	●	●	●	●	●	●	●	●	●	●	●	●	●	●	●	●	●	●	●	●	940		
			D-M9N/M9P/M9B-746																												937		
			D-Y59A/Y7P/Y59B																													941	
			D-Y69A/Y7PV/Y69B																														941
			D-S991/S992/D-S99V1/S99V2																														942
		D-T991/T992/D-T99V1/T99V2																														942	
		D-S9P1/S9P2/D-S9PV1/S9PV2																														942	
		D-S791/S792																														943	
		D-T791/T792																														943	
		D-S7P1/S7P2																														943	
		D-T791C/T792C																														943	
		D-F79/F7P/J79																														944	
		D-F7NV/F7PV/F7BV																														945	
	D-J79C																														946		
	D-F59/F5P/J59																														947		
	2-color indicator	Direct	Grommet	D-M9NW/M9PW/M9BW	●	●	●	●	●	●	●	●	●	●	●	●	●	●	●	●	●	●	●	●	●	●	●	●	●	●	948		
				D-M9NV/M9PV/M9BV	●	●	●	●	●	●	●	●	●	●	●	●	●	●	●	●	●	●	●	●	●	●	●	●	●	●	●	●	948
				D-Y7NW/7PW/7BW																													949
		D-Y7NV/7PV/7BV																														949	
		D-F79W/F7PW/J79W																														950	
	2-color indicator with diagnostic output	Rail	Grommet	D-F7NVV/7BVV																											951		
				D-F79W/F7PW/J79W																													951
	Water resistant 2-color indicator	Tie-rod	Grommet	D-F59W/F5PW/J59W																											952		
				D-F79F																													953
				D-F59F																													954
With timer	Direct	Grommet	D-M9NA/M9PA/M9BA	●	●	●	●	●	●	●	●	●	●	●	●	●	●	●	●	●	●	●	●	●	●	●	●	●	●	955			
			D-M9NAV/M9PAV/M9BAV	●	●	●	●	●	●	●	●	●	●	●	●	●	●	●	●	●	●	●	●	●	●	●	●	●	●	●	●	955	
			D-Y7BA																													956	
Trimmer	Rail	Grommet	D-F7BA/F7BAV																											957			
			D-F5BA																													958	
			D-F7NT																													959	
With timer	Tie-rod	Grommet	D-F5NT																											960			
			D-M9K				●	●				●	●																			961	
			D-Y7K				●	●	●	●																						961	
Reed Auto Switch	Direct	Grommet	D-A90/A93/A96																											973			
			D-A90V/A93V/A96V																													973	
			D-90/97																													974	
			D-90A/93A																													975	
		D-R731/R732																													976		
		D-R801/R802																													976		
		D-R731 C/R732C																													977		
		D-R801 C/R802C																													977		
	Rail	Grommet	D-A72/A73/A80																												978		
			D-A72H/A73H																													979	
			D-A76H/A80H																													979	
		D-A73C/A80C																													980		
		D-A53/A54/A56																													981		
		D-A64/A67																													981		
2-color indicator	Rail	Grommet	D-A79W																											982			
			D-A59W																													983	

Prior to Use

Auto Switches Common Specifications 1

Refer to the Auto Switch Precautions on pages 18 to 22 before using auto switches.

Auto Switches Common Specifications

Type	Reed auto switch	Solid state auto switch
Leakage current	None	3-wire: 100 μ A or less, 2-wire: 0.8 mA or less
Operating time	1.2 ms	1 ms or less *3
Impact resistance	300 m/s ²	1000 m/s ² *4
Insulation resistance	50 M Ω or more (500 VDC measured via megohmmeter) (Between lead wire and case)	
Withstand voltage	1500 VAC for 1 minute *1 (Between lead wire and case)	1000 VAC for 1 minute (Between lead wire and case)
Ambient temperature	-10 to 60°C	
Enclosure	IEC60529 Standard IP67 *2	

- *1 Electrical entry: Connector type (A73C/A80C/C73C/C80C): 1000 VAC/min.
(Between lead wire and case)
- *2 The terminal conduit type (D-A3/A3□/A3□C/G39/G39A/G39C/K39/K39A/K39C), DIN terminal type (D-A44/A44A/A44C), and heat-resistant auto switch (D-F7NJ) are IEC60529 Standard IP63 compliant.
The trimmer type amplifier section (D-R□K) is compliant with IP40.
The enclosure IP rating does not include the switch lead wire end.
For switches with a connector, the enclosure IP requirements are satisfied when the connector is connected.
- *3 Excludes solid state auto switches with a timer (G5NT/F7NT/F5NT types) and the magnetic field resistant 2-color indicator solid state auto switch (D-P3DW□/P4DW)
The operating time for the D-P3DW□/P4DW is 40 ms or less.
- *4 980 m/s² for the trimmer type sensor section, 98 m/s² for the amplifier section

Lead Wire

Lead wire length indication

(Example)

D-M9BW L

Auto switch model

Lead wire length

Symbol	Length	Tolerance	Connector specifications	Solid state	Reed
Nil	0.5 m	\pm 15 mm		●	●
M	1 m	\pm 30 mm		● *2	● *2
L	3 m	\pm 90 mm		●	●
Z	5 m	\pm 150 mm		●	● *3
N *1	None	-		●	●
SAPC	0.5 m	\pm 15 mm	M8-3 pin	○	-
MAPC	1 m	\pm 30 mm	Plug connector	○	-
SBPC	0.5 m	\pm 15 mm	M8-4 pin	○	-
MBPC	1 m	\pm 30 mm	Plug connector	○	-
SDPC	0.5 m	\pm 15 mm	M12-4 pin A code (Normal key) Plug connector	○	-
MDPC	1 m	\pm 30 mm		○	-
LDPC	3 m	\pm 90 mm		○ *7	-

●: Standard ○: Produced upon receipt of order (Standard)

- *1 Applicable to the connector type (D-□□C) only
- *2 Applicable to the D-M9□(V), D-M9□W(V), D-M9□A(V), and D-A93 only
- *3 Applicable to the D-B53/B54, D-C73(C)/C80C, D-A93(V), D-A73(C)/A80C, D-A53/A54, D-Z73, and D-90/97/90A/93A only
- *4 For reed auto switches M8 and M12 type with connector, please contact SMC.
- *5 The standard lead wire length of the trimmer auto switch is 3 m.
- *6 The standard lead wire length of the solid state auto switch with a timer (with the exception of the D-P3DWA and D-M9□A(V)□), water-resistant 2-color indicator solid state auto switch, heat-resistant 2-color indicator solid state auto switch, and strong magnetic field resistant 2-color indicator solid state auto switch is 3 m or 5 m. (Product with a lead wire length of 0.5 m is not available.)
- *7 Applicable to the D-P5DW only

Lead wires with a connector indication

Part No. of Lead Wires with Connectors

(Applicable only for connector type)

Model	Lead wire length
D-LC05	0.5 m
D-LC30	3 m
D-LC50	5 m

Prior to Use

Auto Switches Common Specifications 2

Refer to the Auto Switch Precautions on pages 18 to 22 before using auto switches.

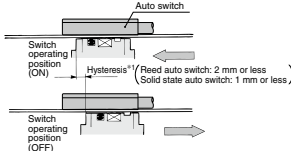
Term	Meaning
Hysteresis	 <p>A deviation amount between the ON position and OFF position caused by auto switch characteristics (difference in sensitivity between ON and OFF). When the switch is turned ON once and the switch (or piston) is moved in the opposite direction, a symptom occurs that causes the switch's OFF position to deviate to a position where it is further returned from the ON position. This deviation amount is called "hysteresis."</p> <p>*1 Hysteresis may fluctuate due to the operating environment. Please contact SMC if hysteresis causes an operational problem.</p>
Most sensitive position	A position (sensor layout position) where the sensitivity on the detection surface of the auto switch enclosure is highest. When the center of the magnet is aligned with this position, it is basically at the center of the operating range and stable operation can be obtained.
Programmable Logic Controller (PLC)	One of the elements that makes up the sequence control. The PLC is designed so that it can receive signals, such as the auto switch output signal, and output them to other devices in order to perform the electrical control according to the preset program.
Operating temperature	A temperature range in which the auto switch can be used. If significant temperature change or freezing occurs even within this temperature range, it may cause the auto switch to malfunction.
Operating voltage	A voltage at which the auto switch can be used. The operating voltage is indicated using generally used voltages (24 VDC, 100 VAC, etc.). For the 2-wire type, the operating voltage has the same meaning as the power supply voltage or load voltage.
Operating current range	A range of the current value that can be flowed to the output of the auto switch. If the operating current is lower than this range, the auto switch may not operate correctly. Conversely, if the operating current is higher than this range, the auto switch may break.
Current consumption	This current value is necessary for the 3-wire type auto switch to operate the circuit through the power cable. For the 2-wire type, as the current consumption is a part of the load current, it is not defined.
Insulation resistance	A resistance between the electric circuit and enclosure. Unless otherwise specified, 50 MΩ (Min) is used for auto switches.
Magnetic field resistant auto switch	An auto switch with protection against the effects of external (welding) magnetic fields generated in the spot welding process, etc. The solid state auto switch is able to function as it detects the frequency of the applied magnetic field. If an external magnetic field (AC) is applied, the last signal is retained and the product remains unaffected by the external magnetic field. This system can be used with cylinders with normal magnetic force. The reed auto switch features a built-in magnetic field shielded sensor with low sensitivity that reduces the effects of external magnetic fields (DC or AC magnetic fields). Therefore, a dedicated cylinder with a strong built-in magnet needs to be selected, and the operable range (conditions) need to be considered.
Impact resistance value	A minimum acceleration that may cause the auto switch to malfunction or break when the standard impact is applied.
Water-resistant auto switch	In contrast with the general (general purpose) product, structural measures have been taken in order to provide this model with long-term water resistance.
Withstand voltage	A tolerated dose of voltage that can be applied to the portion between the electrical circuit and enclosure. The withstand voltage shows the strength level of the product against the voltage. If a voltage exceeding the withstand voltage is applied, it may cause the product to break. (The voltage described here is different from the power supply voltage necessary to operate the product.)
Proper mounting position	A dimension that shows the mounting position when the position is detected at the stroke end of the cylinder. When this position is set, the maximum sensitivity position is aligned with the center of the magnet. However, make the necessary adjustments to the actual machine by considering the characteristic differences of the actual setting. When an adjustment allowance is needed for the detection before the stroke, set a value with an adjustment allowance added to the proper mounting position.
Applicable load	A device that is assumed as a target load of the auto switch.
Operating time	A period of time until the auto switch output becomes stable after the magnetic force to operate the auto switch has been received.
Operating range	An auto switch operating range in response to the cylinder piston movement (ON length in response to the stroke). The operating range is determined by the magnetic force of the magnet (range in which the magnetic force acts) and switch sensitivity. So, the operating range may vary as these conditions can change according to the ambient environment, etc. The operating range in the standard status (normal temperature, single cylinder, magnetic force, sensitivity, etc.) is described in the catalog.

Prior to Use

Auto Switches Common Specifications 3

Refer to the Auto Switch Precautions on pages 18 to 22 before using auto switches.

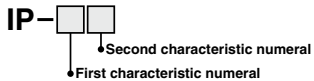
Term	Meaning																																
Minimum stroke for auto switch mounting	A minimum stroke value of the auto switch that can be mounted on the cylinder. The minimum stroke is determined by the specification limit (auto switch operation, position setting ability, etc.) and physical limit (mechanical interference associated with the auto switch mounting). Note that the catalog shows the value assuming that the position detection is performed at the stroke end and that this value does not consider the adjustment allowance. When an adjustment allowance is needed, such as for detection before the stroke, set the value so that this adjustment allowance is added to the minimum stroke.																																
Internal voltage drop	A voltage that is applied to the portion between the COM and signal line when the auto switch is ON. As only the value of the power supply voltage subtracted by the internal voltage drop is applied to the input side of the PLC, a detection fault (incorrect input) may occur if this value is lower than the minimum operating voltage. So, take great care when selecting a device.																																
2-color indicator	As the end part of the auto switch operating range (boundary between ON and OFF) is an area that is susceptible to external disturbances or stroke changes during cylinder operation, this function is intended to quickly and properly make the setting at the center of the operating range where stable operation can be obtained by changing the operation indication color of the auto switch.																																
Load	A device that is connected to the output of the auto switch in order to do any work is called a "load." For example, the load may be a relay, PLC, etc. To check the operation of the auto switch, a device equivalent to a load (such as a resistor, etc.) must be connected.																																
Load current	A current that flows to the load when the ON-OFF output is ON.																																
Enclosure	A class of protection against the entry of water or solids for electrical machinery and apparatus as specified in the IEC60529 Standard.  <p>●First Characteristic: Degree of protection against solid foreign objects</p> <table border="1"> <tbody> <tr><td>0</td><td>Non-protected</td></tr> <tr><td>1</td><td>Protected against solid foreign objects of 50 mm ϕ and greater</td></tr> <tr><td>2</td><td>Protected against solid foreign objects of 12 mm ϕ and greater</td></tr> <tr><td>3</td><td>Protected against solid foreign objects of 2.5 mm ϕ and greater</td></tr> <tr><td>4</td><td>Protected against solid foreign objects of 1.0 mm ϕ and greater</td></tr> <tr><td>5</td><td>Dust-protected</td></tr> <tr><td>6</td><td>Dust-tight</td></tr> </tbody> </table> <p>●Second Characteristic: Degree of protection against water</p> <table border="1"> <tbody> <tr><td>0</td><td>Non-protected</td></tr> <tr><td>1</td><td>Protected against vertically falling water drops</td></tr> <tr><td>2</td><td>Protected against vertically falling water drops when enclosure is tilted 15°</td></tr> <tr><td>3</td><td>Protected against rainfall when enclosure is tilted up to 60°</td></tr> <tr><td>4</td><td>Protected against splashing water</td></tr> <tr><td>5</td><td>Protected against water jets</td></tr> <tr><td>6</td><td>Protected against powerful water jets</td></tr> <tr><td>7</td><td>Protected against the effects of temporary immersion in water</td></tr> <tr><td>8</td><td>Protected against the effects of continuous immersion in water</td></tr> </tbody> </table> <p>Example) In the case of products stipulated as IP65, we can know the degree of protection is dust-tight and water jetproof on the grounds that the first characteristic numeral is 6 and the second characteristic numeral is 5. Therefore, we can assume it will not be adversely affected by direct water jets from any direction.</p>	0	Non-protected	1	Protected against solid foreign objects of 50 mm ϕ and greater	2	Protected against solid foreign objects of 12 mm ϕ and greater	3	Protected against solid foreign objects of 2.5 mm ϕ and greater	4	Protected against solid foreign objects of 1.0 mm ϕ and greater	5	Dust-protected	6	Dust-tight	0	Non-protected	1	Protected against vertically falling water drops	2	Protected against vertically falling water drops when enclosure is tilted 15°	3	Protected against rainfall when enclosure is tilted up to 60°	4	Protected against splashing water	5	Protected against water jets	6	Protected against powerful water jets	7	Protected against the effects of temporary immersion in water	8	Protected against the effects of continuous immersion in water
0	Non-protected																																
1	Protected against solid foreign objects of 50 mm ϕ and greater																																
2	Protected against solid foreign objects of 12 mm ϕ and greater																																
3	Protected against solid foreign objects of 2.5 mm ϕ and greater																																
4	Protected against solid foreign objects of 1.0 mm ϕ and greater																																
5	Dust-protected																																
6	Dust-tight																																
0	Non-protected																																
1	Protected against vertically falling water drops																																
2	Protected against vertically falling water drops when enclosure is tilted 15°																																
3	Protected against rainfall when enclosure is tilted up to 60°																																
4	Protected against splashing water																																
5	Protected against water jets																																
6	Protected against powerful water jets																																
7	Protected against the effects of temporary immersion in water																																
8	Protected against the effects of continuous immersion in water																																
Solid state auto switch	A switch that uses an MR element to detect magnetic fields and possesses an internal judgement circuit that is able to output an ON/OFF signal like a transistor regardless of mechanical contact or non-contact (such as when there is no point of contact).																																
Leak current	A current that flows to operate the internal circuit when the ON-OFF output is OFF. In particular, if the leak current exceeds the detection current in the 2-wire type auto switch or PLC, it may cause a reset failure. So, take great care when selecting a device.																																
Reed auto switch	A switch that uses a reed switch to detect magnetic fields and output an ON/OFF signal when there is mechanical contact or non-contact (when there is a point of contact, such as with a relay or limit switch).																																
Induction load	A load that has a coil. The connection target of the auto switch is a relay.																																
Recommended lead wire bending radius	A minimum bending radius (reference value) of the lead wire when the lead wire is secured and constructed (oscillation or rotation is not considered). (As the temperature and current value conforms to the auto switch specifications, this lead wire bending radius differs from the value disclosed by the electric wire manufacturer.)																																
Electrical entry	A structure in which the lead wire of the auto switch is taken out in the horizontal direction when the cylinder is laid out horizontally (cylinder rod is horizontal) is called an "in-line entry." A structure in which the lead wire is taken out in a direction perpendicular to the cylinder axis center is called a "perpendicular entry."																																

Prior to Use

Auto Switches/Internal Circuits

Solid State Auto Switches

Solid state 3-wire, NPN

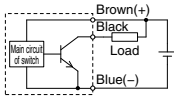

Solid state 3-wire, PNP

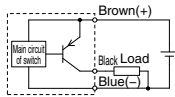

Solid state 2-wire

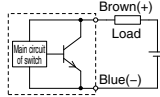

Solid state 2-wire, Non-polar type

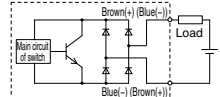

(Power supply for switch and load are separate)

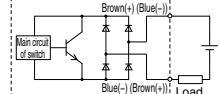
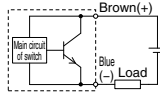
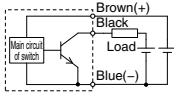

Reed Auto Switches

No.	①	②	③	④
Circuit diagram	<p>2-wire (Reed switch)</p>	<p>2-wire (Reed switch)</p>	<p>2-wire (Reed switch)</p>	<p>2-wire (Reed switch)</p>
No.	⑤	⑥	⑦	
Circuit diagram	<p>3-wire (Reed switch, NPN)</p>	<p>2-wire (Reed switch)</p>	<p>2-wire (Reed switch)</p>	

Contact Protection Box/CD-P11, CD-P12

<Applicable switch models>

D-A7/A8, D-A7□H/A80H, D-A73C, A80C, D-C7/C8, D-C73C/C80C, D-E7□A, E80A, D-Z7/Z8, D-9/9□A, D-A9/A9□V, D-A79W

The auto switches above do not have a built-in contact protection circuit.

A contact protection box is not required for solid state auto switches due to their construction.

- Where the operation load is an inductive load
 - Where the wiring length to the load is 5 m or more
 - Where the load voltage is 100/200 VAC
- Use a contact protection box with the switch for any of the above cases.

The contact life may be shortened (due to permanent energizing conditions).

D-A72(H) must be used with the contact protection box regardless of load types and lead wire length since it is greatly affected by loads.

(Where the load voltage is 110 VAC)

When the load voltage is increased by more than 10% of the rating of the applicable auto switches (Exceptions: D-A73C/A80C/C73C/C80C/90/97/A79W) above, use a contact protection box (CD-P11) to reduce the upper limit of the load current by 10% so that it can be set within the range of the load current range, 110 VAC.

Even for the built-in contact protection circuit type (D-A34[A][C], D-A44[A][C], D-A54/A64, D-A59W, D-B59W), use the contact protection box when the wiring length to the load is very long (30 m or more) and when a PLC (Programmable Logic Controller) with a large inrush current is used.

Contact Protection Box Connection

To connect a switch unit to a contact protection box, connect the lead wire from the side of the contact protection box marked SWITCH to the lead wire coming out of the switch unit. Keep the switch as close as possible to the contact protection box, with a lead wire length of no more than 1 meter.

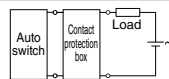

Contact Protection Box Specifications

Part no.	CD-P11	CD-P12
Load voltage	100 VAC or less	200 VAC 24 VDC
Max. load current	25 mA	12.5 mA 50 mA

* Lead wire length — Auto switch connection side 0.5 m
Load connection side 0.5 m

Contact Protection Box Internal Circuit

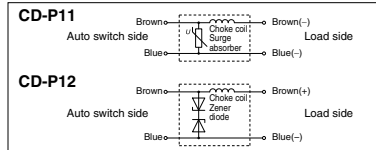

Contact Protection Box/Dimensions

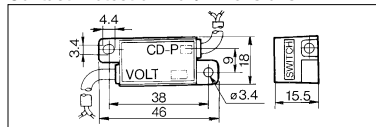

Prior to Use

Auto Switch Connections and Examples

Sink Input Specifications

3-wire, NPN

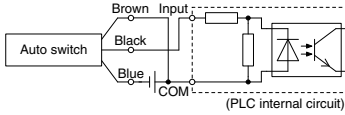

2-wire

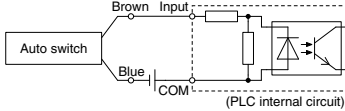

Source Input Specifications

3-wire, PNP

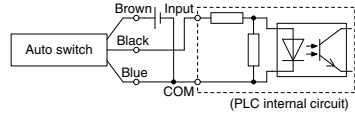

2-wire

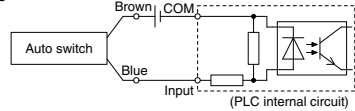

Connect according to the applicable PLC input specifications, as the connection method will vary depending on the PLC input specifications.

Examples of AND (Series) and OR (Parallel) Connections

* When using solid state auto switches, ensure the application is set up so the signals for the first 50 ms are invalid. Depending on the operating environment, the product may not operate properly.

3-wire AND connection for NPN output

(Using relays)

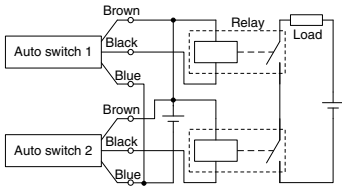

(Performed with auto switches only)

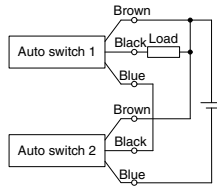

3-wire OR connection for NPN output

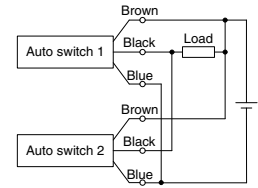

3-wire AND connection for PNP output

(Using relays)

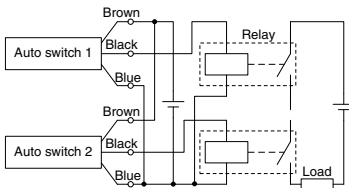

(Performed with auto switches only)

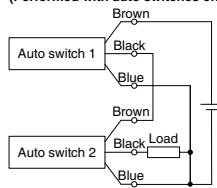

3-wire OR connection for PNP output

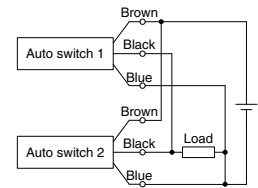

2-wire AND connection

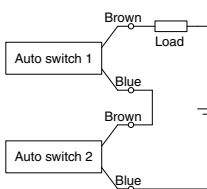

When two auto switches are connected in series, a load may malfunction because the load voltage will decline when in the ON state. The indicator lights will light up when both of the auto switches are in the ON state. Auto switches with a load voltage less than 20 V cannot be used. Please contact SMC if using AND connection for a heat-resistant solid state auto switch or a trimmer switch.

Example) Load voltage at ON
 Power supply voltage: 24 VDC
 Internal voltage drop: 4 V
 Load voltage at ON = Power supply voltage -
 Auto switch internal voltage drop x 2 pcs.
 = 24 V - 4 V x 2 pcs.
 = 16 V

2-wire OR connection

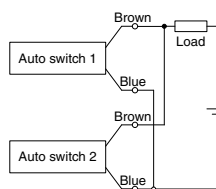

Example) Load voltage at OFF
 Leakage current: 1 mA
 Load impedance: 3 kΩ
 Load voltage at OFF = Leakage current x 2 pcs. x
 Load impedance
 = 1 mA x 2 pcs. x 3 kΩ
 = 6 V

(Solid state)
 When two auto switches are connected in parallel, malfunction may occur because the load voltage will increase when in the OFF state.

(Reed)
 Because there is no current leakage, the load voltage will not increase when turned OFF. However, depending on the number of auto switches in the ON state, the indicator lights may sometimes grow dim or not light up, due to the dispersion and reduction of the current flowing to the auto switches.

Solid State Auto Switch Direct Mounting Type D-M9N(V)/D-M9P(V)/D-M9B(V)



Grommet

- 2-wire load current is reduced (2.5 to 40 mA).
- Using flexible cable as standard spec.



⚠ Caution

Precautions

Fix the auto switch with the existing screw installed on the auto switch body. The auto switch may be damaged if a screw other than the one supplied is used.

Auto Switch Specifications

Refer to SMC website for the details of the products conforming to the international standards.

PLC: Programmable Logic Controller

D-M9□, D-M9□V (With indicator light)						
Auto switch model	D-M9N	D-M9NV	D-M9P	D-M9PV	D-M9B	D-M9BV
Electrical entry direction	In-line	Perpendicular	In-line	Perpendicular	In-line	Perpendicular
Wiring type	3-wire				2-wire	
Output type	NPN		PNP		—	
Applicable load	IC circuit, Relay, PLC				24 VDC relay, PLC	
Power supply voltage	5, 12, 24 VDC (4.5 to 28 V)				—	
Current consumption	10 mA or less				—	
Load voltage	28 VDC or less		—		24 VDC (10 to 28 VDC)	
Load current	40 mA or less		—		2.5 to 40 mA	
Internal voltage drop	0.8 V or less at 10 mA (2 V or less at 40 mA)				4 V or less	
Leakage current	100 μA or less at 24 VDC				0.8 mA or less	
Indicator light	Red LED illuminates when turned ON.					
Standard	CE/UKCA marking					

Oilproof Heavy-duty Lead Wire Specifications

Auto switch model		D-M9N(V)	D-M9P(V)	D-M9B(V)
Sheath	Outside diameter [mm]	2.6		
Insulator	Number of cores	3 cores (Brown/Blue/Black)		2 cores (Brown/Blue)
	Outside diameter [mm]	0.88		
Conductor	Effective area [mm ²]	0.15		
	Strand diameter [mm]	0.05		
Minimum bending radius [mm] (Reference values)		17		

Note 1) Refer to page 932 for solid state auto switch common specifications.
Note 2) Refer to page 932 for lead wire lengths.

Weight

(g)

Auto switch model		D-M9N(V)	D-M9P(V)	D-M9B(V)
Lead wire length	0.5 m (Nii)	8	7	7
	1 m (M)	14	13	13
	3 m (L)	41	38	38
	5 m (Z)	68	63	63

Dimensions

(mm)

D-M9□

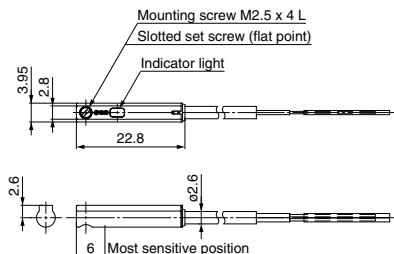

D-M9□V

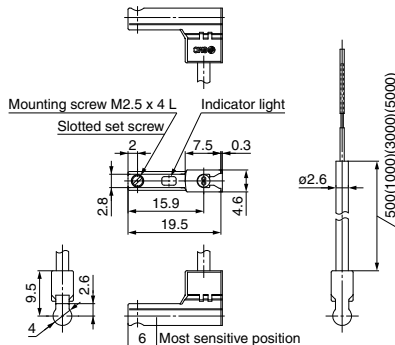

Solid State Auto Switch Direct Mounting Type

Produced upon receipt of order



D-M9N-5/D-M9P-5/D-M9B-5



Refer to SMC website for the details of the products conforming to the international standards.

Grommet

- Overall length reduced by 32%
22 mm → 15 mm
- Specifications are the same as those of the standard product (D-M9□).
- Protrusion from the actuator end surface has been reduced.

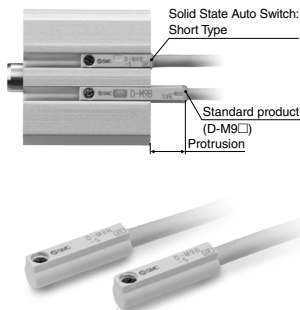

Auto Switch Specifications

PLC: Programmable Logic Controller

Auto switch model	D-M9N□-5	D-M9P□-5	D-M9B□-5
Wiring type	3-wire		2-wire
Output type	NPN	PNP	—
Applicable load	IC circuit, Relay, PLC		24 VDC relay, PLC
Power supply voltage	5, 12, 24 VDC (4.5 to 28 V)		—
Current consumption	10 mA or less		—
Load voltage	28 VDC or less	—	24 VDC (10 to 28 VDC)
Load current	40 mA or less		2.5 to 40 mA
Internal voltage drop	0.8 V or less at 10 mA (2 V or less at 40 mA)		4 V or less
Leakage current	100 μA or less at 24 VDC		0.8 mA or less
Indicator light	Red LED lights up when turned ON.		
Standards	CE/UKCA marking		

Oilproof Heavy-duty Lead Wire Specifications

Auto switch model	D-M9N□-5	D-M9P□-5	D-M9B□-5
Sheath	Outside diameter [mm] $\phi 2.6$		
Insulator	Number of cores		3 cores (Brown/Blue/Black) 2 cores (Brown/Blue)
	Outside diameter [mm]		$\phi 0.88$
Conductor	Effective area [mm ²]		0.15
	Strand diameter [mm]		$\phi 0.05$
Min. bending radius [mm] (Reference value)			17

Note 1) Refer to page 932 for solid state auto switch common specifications.

Note 2) Refer to page 932 for lead wire lengths.

Caution

Precautions

Fix the auto switch with the existing screw installed on the auto switch body. The auto switch may be damaged if a screw other than the one supplied is used.

Weight

(g)

Auto switch model	D-M9N□-5	D-M9P□-5	D-M9B□-5
Lead wire length	0.5 m (Nil)	7	6
	1 m (M)	13	11
	3 m (L)	35	31
	5 m (Z)	57	51

How to Order

D-M9 B L - 5

Wiring/ Output type	Lead wire length
B 2-wire	Nil 0.5 m
N 3-wire, NPN	M 1 m
P 3-wire, PNP	L 3 m
	Z 5 m

Dimensions

(mm)

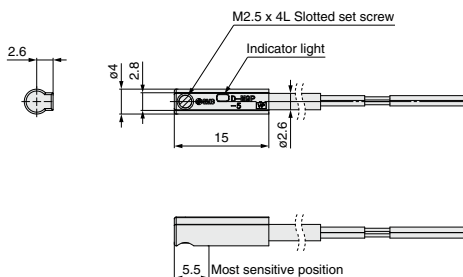

Auto Switch Proper Mounting Position (Detection at stroke end)

■ The A and B dimensions are equivalent to the dimensions of the standard product (D-M9□) + 0.5 mm.

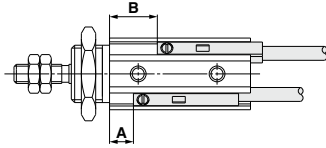

■ Actuators in which the protrusion from the body end surface can be eliminated by mounting the D-M9□-5

Description	Series	Note
Air Cylinder	CJP2	
Mini Free Mount Cylinder	CUJ	Excludes ø6, ø8, ø10, and ø12 (See right side.)
Free Mount Cylinder	CU	
Compact Cylinder	CQS	
Compact Cylinder: Guide Rod Type	CQM	
Compact Slide	MXH	Excludes ø6 (See right side.)
Air Slide Table	MXJ	
Platform Cylinder	CXT	
Dual Rod Cylinder	CXSJ	Excludes ø6 and ø10 (See right side.)
Rotary Clamp Cylinder	MK	
Escapements	MI□	
Compact Type Parallel Style Air Gripper	JMHZ2	Excludes ø8 and ø12 (See right side.)
Parallel Type Air Gripper	MHZ2	Excludes ø6 (See right side.)
Parallel Type Air Gripper	MHZJ2	Excludes ø6 and ø10 (See right side.)
Parallel Type Air Gripper	MHZL2	Excludes ø10 (See right side.)
Low Profile Air Gripper	MHF2	
Parallel Type Air Gripper	MHS□	Excludes the center pusher (cylinder type) (See right side.)
Angular Type Air Gripper	MHC2	Excludes ø6 and ø10 (See right side.)
180° Angular Type Air Gripper: Cam Type	MHY2	
180° Angular Type Air Gripper: Rack & Pinion Type	MHW2	Excludes ø20 and ø25 (See right side.)

■ Protrusion from the body end surface

Model	Bore size	Protrusion
CUJ	6	0.5
	8	0.5
	10	0.5
	12	0.5

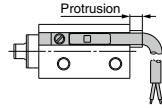

Model	Bore size	Protrusion
MXH	6	1

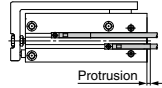

Model	Bore size	Protrusion
CXSJ	6	3
	10	0.5

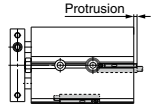

Model	Bore size	Finger position	Protrusion
JMHZ2	8	Closed	1
	12	Closed	1
MHZ2	6	Open	4.5
		Closed	6.5
MHZL2	10	Closed	1.5
		Open	4.5
MHZJ2	6	Closed	6.5
		Closed	0.5

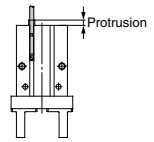

Model	Bore size	Rod position	Protrusion
MHS3	32	Retracted	2.5
	40	Retracted	1.5
	50	Retracted	1
	60	Retracted	0.5

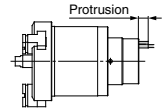

Model	Bore size	Finger position	Protrusion
MHC2	6	Closed	2.5
	10	Closed	1

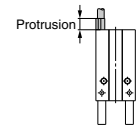

Model	Bore size	Finger position	Protrusion
MHW2	20	Closed	0.5
	25	Closed	0.5

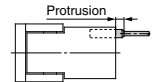

* Adjust the auto switch after confirming the operating conditions in the actual setting.

Solid State Auto Switch Direct Mounting Type D-F8N/D-F8P/D-F8B



Refer to SMC website for the details of the products conforming to the international standards.

Auto Switch Specifications

PLC: Programmable Logic Controller

D-F8□ (With indicator light)			
Auto switch model	D-F8N	D-F8P	D-F8B
Electrical entry direction	Perpendicular	Perpendicular	Perpendicular
Wiring type	3-wire		2-wire
Output type	NPN	PNP	—
Applicable load	IC circuit, 24 VDC Relay, PLC		24 VDC relay, PLC
Power supply voltage	5, 12, 24 VDC (4.5 to 28 VDC)		—
Current consumption	10 mA or less		—
Load voltage	28 VDC or less	—	24 VDC (10 to 28 VDC)
Load current	40 mA or less	80 mA or less	2.5 to 40 mA
Internal voltage drop	1.5 V or less (0.8 V or less at 10 mA load current)	0.8 V or less	4 V or less
Leakage current	100 μA or less at 24 VDC		0.8 mA or less at 24 VDC
Indicator light	Red LED illuminates when turned ON.		
Standard	CE/UKCA marking		

Grommet



Caution

Precautions

Fix the auto switch with the existing screw installed on the auto switch body. The auto switch may be damaged if a screw other than the one supplied is used.

Oilproof Heavy-duty Lead Wire Specifications

Auto switch model		D-F8N	D-F8P	D-F8B
Sheath	Outside diameter (mm)	ø2.7		
	Number of cores	3 cores (Brown/Blue/Black)		2 cores (Brown/Blue)
Insulator	Outside diameter (mm)	ø0.91		ø0.96
	Effective area (mm ²)	0.15		0.18
Conductor	Strand diameter (mm)	ø0.08		
	Minimum bending radius (mm) (Reference values)	17		

Note 1) Refer to page 932 for solid state auto switch common specifications.

Note 2) Refer to page 932 for lead wire lengths.

Weight

(g)

Auto switch model		D-F8N	D-F8P	D-F8B
Lead wire length	0.5 m (NII)	7		
	3 m (L)	32		
	5 m (Z)	52		

Dimensions

(mm)

D-F8N/D-F8P/D-F8B

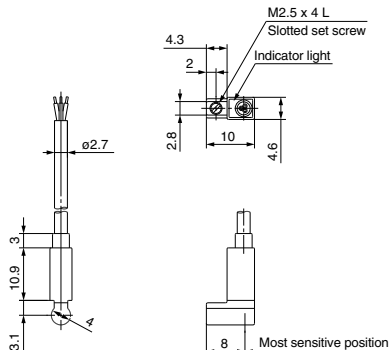

Solid State Auto Switch Direct Mounting Type D-Y59^A_B / D-Y69^A_B / D-Y7P(V)



Refer to SMC website for the details of the products conforming to the international standards.

Auto Switch Specifications

PLC: Programmable Logic Controller

D-Y5□, D-Y6□, D-Y7P, D-Y7PV (With indicator light)						
Auto switch model	D-Y59A	D-Y69A	D-Y7P	D-Y7PV	D-Y59B	D-Y69B
Electrical entry direction	In-line	Perpendicular	In-line	Perpendicular	In-line	Perpendicular
Wiring type	3-wire				2-wire	
Output type	NPN		PNP		—	
Applicable load	IC circuit, Relay, PLC				24 VDC relay, PLC	
Power supply voltage	5, 12, 24 VDC (4.5 to 28 VDC)				—	
Current consumption	10 mA or less				—	
Load voltage	28 VDC or less		—		24 VDC (10 to 28 VDC)	
Load current	40 mA or less		80 mA or less		2.5 to 40 mA	
Internal voltage drop	1.5 V or less (0.8 V or less at 10 mA load current)		0.8 V or less		4 V or less	
Leakage current	100 μA or less at 24 VDC				0.8 mA or less at 24 VDC	
Indicator light	Red LED illuminates when turned ON.					
Standard	CE/UKCA marking					

Grommet

Using flexible cable as standard spec.



Oilproof Flexible Heavy-duty Lead Wire Specifications

Auto switch model		D-Y□9A	D-Y7P□	D-Y□9B
Sheath	Outside diameter [mm]	ø3.4		
	Number of cores	3 cores (Brown/Blue/Black)		2 cores (Brown/Blue)
Insulator	Outside diameter [mm]	ø1.0		
	Effective area [mm ²]	0.15		
Conductor	Strand diameter [mm]	ø0.05		
	Minimum bending radius [mm] (Reference values)	21		

Note 1) Refer to page 932 for solid state auto switch common specifications.
Note 2) Refer to page 932 for lead wire lengths.

Weight

(g)

Auto switch model		D-Y59A	D-Y69A	D-Y7P(V)	D-Y59B	D-Y69B
Lead wire length	0.5 m (NII)	10			9	
	3 m (L)	53			50	
	5 m (Z)	87			83	

Dimensions

(mm)

D-Y59A/D-Y7P/D-Y59B

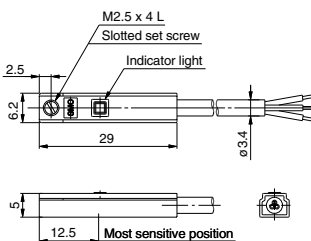

D-Y69A/D-Y7PV/D-Y69B

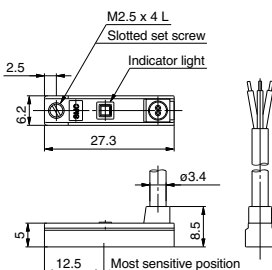

Solid State Auto Switch Direct Mounting Type D-S99(V)/D-S9P(V)/D-T99(V)



RoHS

Refer to SMC website for the details of the products conforming to the international standards.

Auto Switch Specifications

PLC: Programmable Logic Controller

D-S99(V)/D-S9P(V)/D-T99(V) (With indicator light)						
Auto switch model	D-S991	D-S99V1	D-S9P1	D-S9PV1	D-T991	D-T99V1
Electrical entry direction	In-line	Perpendicular	In-line	Perpendicular	In-line	Perpendicular
Wiring type	3-wire			2-wire		
Output type	NPN			PNP		
Applicable load	IC circuit, Relay, PLC			24 VDC relay, PLC		
Power supply voltage	5, 12, 24 VDC (4.5 to 28 VDC)			—		
Current consumption	10 mA or less			—		
Load voltage	28 VDC or less			24 VDC (10 to 28 VDC)		
Load current	40 mA or less			80 mA or less		
Internal voltage drop	1.5 V or less (0.8 V or less at 10 mA load current)			0.8 V or less		
Leakage current	100 μ A or less at 24 VDC			0.8 mA or less at 24 VDC		
Indicator light	Red LED illuminates when turned ON.			—		
Standard	CE/UKCA marking			—		

Note 1) Refer to page 932 for solid state auto switch common specifications.

Note 2) Refer to page 932 for lead wire lengths.

Oilproof Heavy-duty Lead Wire Specifications

Auto switch model	D-S99□	D-S9P□	D-T99□
Sheath	Outside diameter (mm)		ϕ 3.4
	Number of cores		2 cores (Brown/Black)
Insulator	Outside diameter (mm)		ϕ 1.1
	Effective area (mm ²)		0.2
Conductor	Strand diameter (mm)		ϕ 0.08
Minimum bending radius (mm) (Reference values)			21

Weight

(g)

Auto switch model	D-S99□	D-S99V□	D-S9P□	D-S9PV□	D-T99□	D-T99V□
Lead wire length	0.5 m (Nil)	12	12	12	12	12
	3 m (L)	49	46	46	46	46
	5 m (Z)	79	79	79	79	79

Dimensions

(mm)

D-S991: Right-hand mounting
D-S9P1:
D-T991:

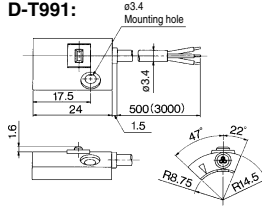

D-S992: Left-hand mounting
D-S9P2:
D-T992:

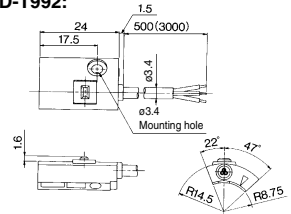

D-S99V1: Right-hand mounting
D-S9PV1:
D-T99V1:

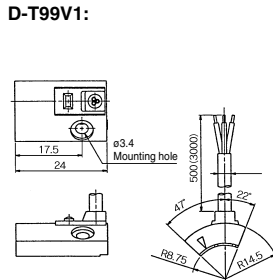

D-S99V2: Left-hand mounting
D-S9PV2:
D-T99V2:

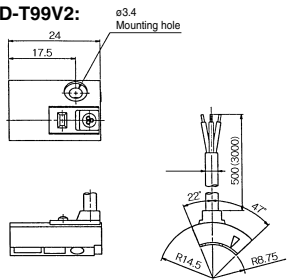

Grommet



D-□□□1



Right-hand mounting

D-□□□2



Left-hand mounting

D-□□□V1



Right-hand mounting

D-□□□V2



Left-hand mounting

Solid State Auto Switch Direct Mounting Type D-S79/D-S7P/D-T79(C)



Grommet, Connector Electrical Entry: In-line

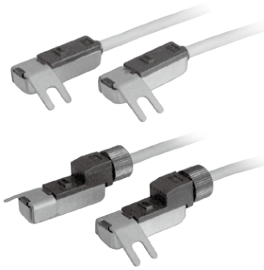

D-□□□2

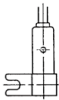

Left-hand mounting

D-□□□1

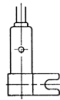

Right-hand mounting

⚠ Caution

Precautions

1. Confirm that the connector is appropriately tightened. If tightened insufficiently, the waterproof performance will deteriorate.
2. Refer to the **Web Catalog** for the details.

Lead wires with a connector indication

Part No. of Lead Wires with Connectors (Applicable only for connector type)

Model	Lead wire length
D-LC05	0.5 m
D-LC30	3 m
D-LC50	5 m

Auto Switch Specifications

Refer to SMC website for the details of the products conforming to the international standards.

PLC: Programmable Logic Controller

D-S79/D-T79 (With indicator light)			
Auto switch model	D-S791, D-S792	D-S7P1, D-S7P2	D-T791, D-T792, D-T791C, D-T792C
Wiring type	3-wire		2-wire
Output type	NPN	PNP	—
Applicable load	IC circuit, Relay, PLC		24 VDC relay, PLC
Power supply voltage	5, 12, 24 VDC (4.5 to 28 VDC)		—
Current consumption	10 mA or less		—
Load voltage	28 VDC or less	—	24 VDC (10 to 28 VDC)
Load current	40 mA or less	80 mA or less	5 to 40 mA
Internal voltage drop	1.5 V or less (0.8 V or less at 10 mA load current)	0.8 V or less	4 V or less
Leakage current	100 μA or less at 24 VDC		0.8 mA or less at 24 VDC
Indicator light	Red LED illuminates when turned ON.		
Standard	CE/UKCA marking		

Note 1) Refer to page 932 for solid state auto switch common specifications.

Note 2) Refer to page 932 for lead wire lengths.

Oilproof Heavy-duty Lead Wire Specifications

Auto switch model		D-S79□	D-S7P□	D-T79□
Sheath	Outside diameter (mm)	ø3.4		
	Number of cores	3 cores (Brown/Blue/Black)		2 cores (Brown/Blue)
Insulator	Outside diameter (mm)	ø1.1		
	Effective area (mm ²)	0.2		
Conductor	Strand diameter (mm)	ø0.08		
	Minimum bending radius (mm) (Reference values)	21		

Weight

(g)

Auto switch model		D-S79□	D-S7P□	D-T79□	D-T79□C
Lead wire length	0.5 m (Nil)	13	13	13	14
	3 m (L)	50	50	50	51
	5 m (Z)	80	80	80	81

Dimensions

(mm)

D-S791: Right-hand mounting

D-S7P1:

D-T791:

D-S792: Left-hand mounting

D-S7P2:

D-T792:

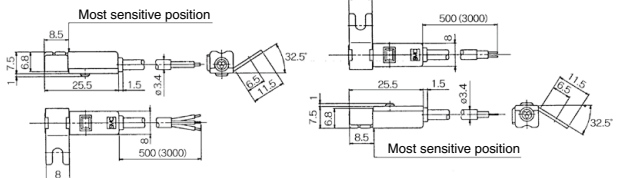

D-T791C: Right-hand mounting

D-T792C: Left-hand mounting

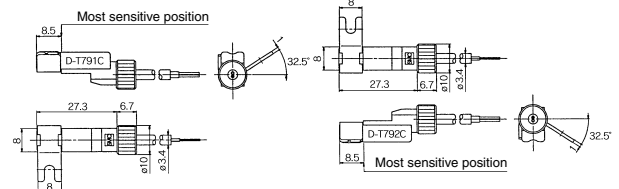

Solid State Auto Switch Rail Mounting Type D-F79/D-F7P/D-J79



Refer to SMC website for the details of the products conforming to the international standards.

Auto Switch Specifications

PLC: Programmable Logic Controller

Grommet



D-F7□, D-J79 (With indicator light)			
Auto switch model	D-F79	D-F7P	D-J79
Wiring type	3-wire		2-wire
Output type	NPN	PNP	—
Applicable load	IC circuit, Relay, PLC		24 VDC Relay, PLC
Power supply voltage	5, 12, 24 VDC (4.5 to 28 VDC)		—
Current consumption	10 mA or less		—
Load voltage	28 VDC or less	—	24 VDC (10 to 28 VDC)
Load current	40 mA or less	80 mA or less	5 to 40 mA
Internal voltage drop	1.5 V or less (0.8 V or less at 10 mA load current)	0.8 V or less	4 V or less
Leakage current	100 μ A or less at 24 VDC		0.8 mA or less at 24 VDC
Indicator light	Red LED illuminates when turned ON.		
Standard	CE/UKCA marking		

Oilproof Heavy-duty Lead Wire Specifications

Auto switch model		D-F79	D-F7P	D-J79
Sheath	Outside diameter [mm]	ϕ 3.4		
Insulator	Number of cores	3 cores (Brown/Blue/Black)		2 cores (Brown/Blue)
	Outside diameter [mm]	ϕ 1.1		
Conductor	Effective area [mm ²]	0.2		
	Strand diameter [mm]	ϕ 0.08		
Minimum bending radius [mm] (Reference values)		21		

Note 1) Refer to page 932 for solid state auto switch common specifications.

Note 2) Refer to page 932 for lead wire lengths.

Weight

(g)

Auto switch model		D-F79	D-F7P	D-J79
Lead wire length	0.5 m (NII)	13		11
	3 m (L)	57		50
	5 m (Z)	92		81

Dimensions

(mm)

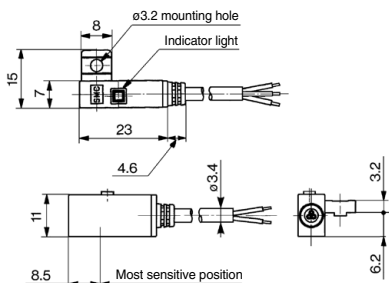

Solid State Auto Switch Rail Mounting Type D-F7NV/D-F7PV/D-F7BV



Refer to SMC website for the details of the products conforming to the international standards.

PLC: Programmable Logic Controller

Grommet
Electrical entry: Perpendicular



Auto Switch Specifications

D-F7□V (With indicator light)			
Auto switch model	D-F7NV	D-F7PV	D-F7BV
Wiring type	3-wire		2-wire
Output type	NPN	PNP	—
Applicable load	IC circuit, Relay, PLC		24 VDC Relay, PLC
Power supply voltage	5, 12, 24 VDC (4.5 to 28 VDC)		—
Current consumption	10 mA or less		—
Load voltage	28 VDC or less	—	24 VDC (10 to 28 VDC)
Load current	40 mA or less	80 mA or less	5 to 40 mA
Internal voltage drop	1.5 V or less (0.8 V or less at 10 mA load current)	0.8 V or less	4 V or less
Leakage current	100 μA or less at 24 VDC		0.8 mA or less at 24 VDC
Indicator light	Red LED illuminates when turned ON.		
Standard	CE/UKCA marking		

Oilproof Heavy-duty Lead Wire Specifications

Auto switch model		D-F7NV	D-F7PV	D-F7BV
Sheath	Outside diameter [mm]	ø3.4		
Insulator	Number of cores	3 cores (Brown/Blue/Black)		2 cores (Brown/Blue)
	Outside diameter [mm]	ø1.1		
Conductor	Effective area [mm ²]	0.2		
	Strand diameter [mm]	ø0.08		
Minimum bending radius [mm] (Reference values)		21		

Note 1) Refer to page 932 for solid state auto switch common specifications.

Note 2) Refer to page 932 for lead wire lengths.

Weight

(g)

Auto switch model		D-F7NV	D-F7PV	D-F7BV
Lead wire length	0.5 m (NII)	13	—	11
	3 m (L)	57	—	50
	5 m (Z)	92	—	81

Dimensions

(mm)

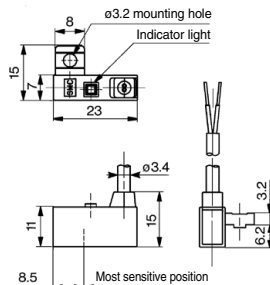

Solid State Auto Switch Rail Mounting Type D-J79C



Refer to SMC website for the details of the products conforming to the international standards.

Auto Switch Specifications

PLC: Programmable Logic Controller

D-J79C (With indicator light)	
Auto switch model	D-J79C
Wiring type	2-wire
Output type	—
Applicable load	24 VDC Relay, PLC
Power supply voltage	—
Current consumption	—
Load voltage	24 VDC (10 to 28 VDC)
Load current	5 to 40 mA
Internal voltage drop	4 V or less
Leakage current	0.8 mA or less at 24 VDC
Indicator light	Red LED illuminates when turned ON.
Standard	CE/UKCA marking

Note 1) Refer to page 932 for solid state auto switch common specifications.

Note 2) Refer to page 932 for lead wire lengths.

Note 3) Lead wires with a connector may be shipped with auto switches.

Weight

(g)

Auto switch model		D-J79C
Lead wire length	0.5 m (NII)	13
	3 m (L)	52
	5 m (Z)	83

Dimensions

(mm)

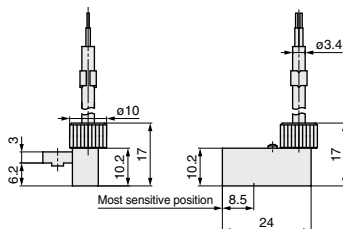
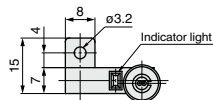

Connector

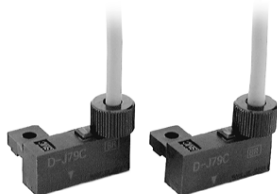

Caution

Precautions

1. Confirm that the connector is appropriately tightened. If tightened insufficiently, the waterproof performance will deteriorate.
2. Refer to the **Web Catalog** for the details.

Lead wires with a connector indication

Part No. of Lead Wires with Connectors
(Applicable only for connector type)

Model	Lead wire length
D-LC05	0.5 m
D-LC30	3 m
D-LC50	5 m

Solid State Auto Switch Tie-rod Mounting Type D-F59/D-F5P/D-J59



Grommet



Refer to SMC website for the details of the products conforming to the international standards.

Auto Switch Specifications

PLC: Programmable Logic Controller

D-F5□, D-J59 (With indicator light)			
Auto switch model	D-F59	D-F5P	D-J59
Wiring type	3-wire		2-wire
Output type	NPN	PNP	—
Applicable load	IC circuit, Relay, PLC		24 VDC Relay, PLC
Power supply voltage	5, 12, 24 VDC (4.5 to 28 VDC)		—
Current consumption	10 mA or less		—
Load voltage	28 VDC or less	—	24 VDC (10 to 28 VDC)
Load current	40 mA or less	80 mA or less	5 to 40 mA
Internal voltage drop	1.5 V or less (0.8 V or less at 10 mA load current)	0.8 V or less	4 V or less
Leakage current	100 μA or less at 24 VDC		0.8 mA or less at 24 VDC
Indicator light	Red LED illuminates when turned ON.		
Standard	CE/UKCA marking		

Oilproof Heavy-duty Lead Wire Specifications

Auto switch model		D-F59	D-F5P	D-J59
Sheath	Outside diameter [mm]	ø4		
	Number of cores	3 cores (Brown/Blue/Black)	2 cores (Brown/Blue)	
Insulator	Outside diameter [mm]	ø1.22		
	Effective area [mm ²]	0.3		
Conductor	Strand diameter [mm]	ø0.08		
	Minimum bending radius [mm] (Reference values)	24		

Note 1) Refer to page 932 for solid state auto switch common specifications.
Note 2) Refer to page 932 for lead wire lengths.

Weight

(g)

Auto switch model		D-F59	D-F5P	D-J59
Lead wire length	0.5 m (NII)	23	—	21
	3 m (L)	81	—	71
	5 m (Z)	127	—	111

Dimensions

(mm)

D-F59/D-F5P/D-J59

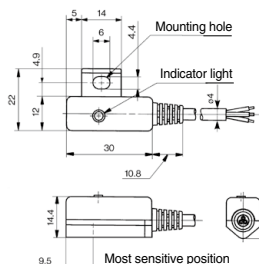

2-Color Indicator Solid State Auto Switch Direct Mounting Type D-M9NW(V)/D-M9PW(V)/D-M9BW(V)



Refer to SMC website for the details of the products conforming to the international standards.

Auto Switch Specifications

PLC: Programmable Logic Controller

D-M9□W, D-M9□WV (With indicator light)						
Auto switch model	D-M9NW	D-M9NWV	D-M9PW	D-M9PWV	D-M9BW	D-M9BWV
Electrical entry direction	In-line	Perpendicular	In-line	Perpendicular	In-line	Perpendicular
Wiring type	3-wire			2-wire		
Output type	NPN		PNP		—	
Applicable load	IC circuit, Relay, PLC				24 VDC relay, PLC	
Power supply voltage	5, 12, 24 VDC (4.5 to 28 V)				—	
Current consumption	10 mA or less				—	
Load voltage	28 VDC or less		—		24 VDC (10 to 28 VDC)	
Load current	40 mA or less				2.5 to 40 mA	
Internal voltage drop	0.8 V or less at 10 mA (2 V or less at 40 mA)				4 V or less	
Leakage current	100 μA or less at 24 VDC				0.8 mA or less	
Indicator light	Operating range Red LED illuminates. Proper operating range Green LED illuminates.					
Standard	CE/UKCA marking					

Grommet

- 2-wire load current is reduced (2.5 to 40 mA).
- Using flexible cable as standard spec.
- The proper operating range can be determined by the color of the light. (Red → Green ← Red)



Caution

Precautions

Fix the auto switch with the existing screw installed on the auto switch body. The auto switch may be damaged if a screw other than the one supplied is used.

Oilproof Flexible Heavy-duty Lead Wire Specifications

Auto switch model		D-M9NW(V)	D-M9PW(V)	D-M9BW(V)
Sheath	Outside diameter [mm]	2.6		
Insulator	Number of cores	3 cores (Brown/Blue/Black)		2 cores (Brown/Blue)
	Outside diameter [mm]	0.88		
Conductor	Effective area [mm ²]	0.15		
	Strand diameter [mm]	0.05		
Minimum bending radius [mm] (Reference values)		17		

Note 1) Refer to page 932 for solid state auto switch common specifications.

Note 2) Refer to page 932 for lead wire lengths.

Weight

(g)

Auto switch model		D-M9NW(V)	D-M9PW(V)	D-M9BW(V)
Lead wire length	0.5 m (NII)	8	7	7
	1 m (M)	14	13	13
	3 m (L)	41	38	38
	5 m (Z)	68	63	63

Dimensions

(mm)

D-M9□W

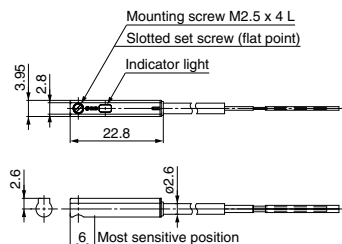

D-M9□WV

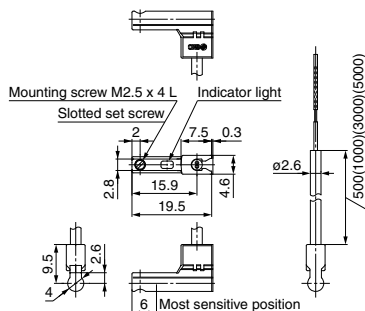

2-Color Indicator Solid State Auto Switch Direct Mounting Type D-Y7NW(V)/D-Y7PW(V)/D-Y7BW(V)



Refer to SMC website for the details of the products conforming to the international standards.

Auto Switch Specifications

PLC: Programmable Logic Controller

D-Y7□W, D-Y7□WV (With indicator light)						
Auto switch model	D-Y7NW	D-Y7NWV	D-Y7PW	D-Y7PWV	D-Y7BW	D-Y7BWV
Electrical entry direction	In-line	Perpendicular	In-line	Perpendicular	In-line	Perpendicular
Wiring type	3-wire				2-wire	
Output type	NPN		PNP		—	
Applicable load	IC circuit, Relay, PLC				24 VDC relay, PLC	
Power supply voltage	5, 12, 24 VDC (4.5 to 28 VDC)				—	
Current consumption	10 mA or less				—	
Load voltage	28 VDC or less		—		24 VDC (10 to 28 VDC)	
Load current	40 mA or less		80 mA or less		2.5 to 40 mA	
Internal voltage drop	1.5 V or less (0.8 V or less at 10 mA load current)		0.8 V or less		4 V or less	
Leakage current	100 μA or less at 24 VDC				0.8 mA or less at 24 VDC	
Indicator light	Operating range Red LED illuminates. Proper operating range Green LED illuminates.					
Standard	CE/UKCA marking					

Grommet

- The proper operating range can be determined by the color of the light.
(Red → Green ← Red)
- Using flexible cable as standard spec.

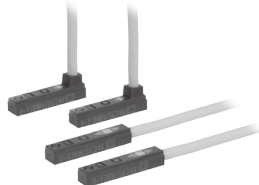

Oilproof Flexible Heavy-duty Lead Wire Specifications

Auto switch model		D-Y7NW□	D-Y7PW□	D-Y7BW□
Sheath	Outside diameter [mm]	ø3.4		
Insulator	Number of cores	3 cores (Brown/Blue/Black)		2 cores (Brown/Blue)
	Outside diameter [mm]	ø1.0		
Conductor	Effective area [mm ²]	0.15		
	Strand diameter [mm]	ø0.05		
Minimum bending radius [mm] (Reference values)		21		

Note 1) Refer to page 932 for solid state auto switch common specifications.
Note 2) Refer to page 932 for lead wire lengths.

Weight

(g)

Auto switch model		D-Y7NW(V)	D-Y7PW(V)	D-Y7BW(V)
Lead wire length	0.5 m (Nil)	11		
	3 m (L)	54		
	5 m (Z)	88		

Dimensions

(mm)

D-Y7□W

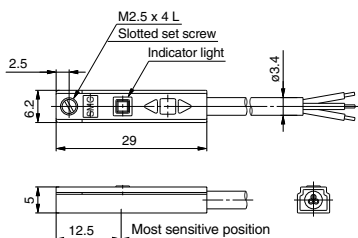

D-Y7□WV

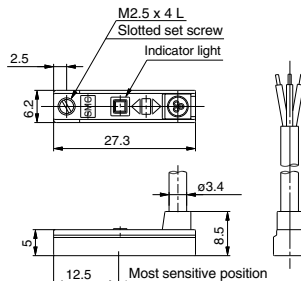

2-Color Indicator Solid State Auto Switch Rail Mounting Type D-F79W/D-F7PW/D-J79W



Grommet

The proper operating range can be determined by the color of the light.
(Red → Green ← Red)



Auto Switch Specifications

Refer to SMC website for the details of the products conforming to the international standards.

PLC: Programmable Logic Controller

D-F7□W, D-J79W (With indicator light)			
Auto switch model	D-F79W	D-F7PW	D-J79W
Wiring type	3-wire		2-wire
Output type	NPN	PNP	—
Applicable load	IC circuit, Relay, PLC		24 VDC Relay, PLC
Power supply voltage	5, 12, 24 VDC (4.5 to 28 VDC)		—
Current consumption	10 mA or less		—
Load voltage	28 VDC or less	—	24 VDC (10 to 28 VDC)
Load current	40 mA or less	80 mA or less	5 to 40 mA
Internal voltage drop	1.5 V or less (0.8 V or less at 10 mA load current)	0.8 V or less	4 V or less
Leakage current	100 μA or less at 24 VDC		0.8 mA or less at 24 VDC
Indicator light	Operating range Red LED illuminates. Proper operating range Green LED illuminates.		
Standard	CE/UKCA marking		

Oilproof Heavy-duty Lead Wire Specifications

Auto switch model		D-F79W	D-F7PW	D-J79W
Sheath	Outside diameter [mm]	ø3.4		
Insulator	Number of cores	3 cores (Brown/Blue/Black)		2 cores (Brown/Blue)
	Outside diameter [mm]	ø1.1		
Conductor	Effective area [mm ²]	0.2		
	Strand diameter [mm]	ø0.08		
Minimum bending radius [mm] (Reference values)		21		

Note 1) Refer to page 932 for solid state auto switch common specifications.
Note 2) Refer to page 932 for lead wire lengths.

Weight

(g)

Auto switch model		D-F79W	D-F7PW	D-J79W
Lead wire length	0.5 m (NII)	13		11
	3 m (L)	57		50
	5 m (Z)	92		81

Dimensions

(mm)

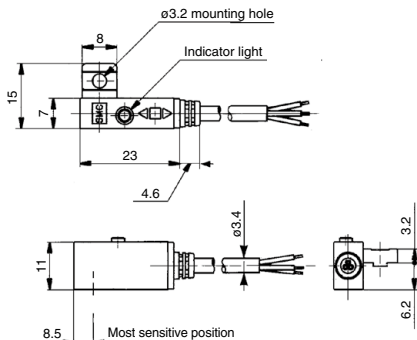

2-Color Indicator Solid State Auto Switch Rail Mounting Type D-F7NWV/D-F7BWV



Refer to SMC website for the details of the products conforming to the international standards.

PLC: Programmable Logic Controller

**Grommet
Electrical entry: Perpendicular**

The proper operating range can be determined by the color of the light.

(Red → Green ← Red)



Auto Switch Specifications

D-F7□WV (With indicator light)		
Auto switch model	D-F7NWV	D-F7BWV
Wiring type	3-wire	2-wire
Output type	NPN	—
Applicable load	IC circuit, Relay, PLC	24 VDC Relay, PLC
Power supply voltage	5, 12, 24 VDC (4.5 to 28 VDC)	—
Current consumption	10 mA or less	—
Load voltage	28 VDC or less	24 VDC (10 to 28 VDC)
Load current	40 mA or less	5 to 40 mA
Internal voltage drop	1.5 V or less (0.8 V or less at 10 mA load current)	4 V or less
Leakage current	100 μA or less at 24 VDC	0.8 mA or less at 24 VDC
Indicator light	Operating range Red LED illuminates. Proper operating range Green LED illuminates.	
Standard	CE/UKCA marking	

Oilproof Heavy-duty Lead Wire Specifications

Auto switch model		D-F7NWV	D-F7BWV
Sheath	Outside diameter [mm]	ø3.4	
Insulator	Number of cores	3 cores (Brown/Blue/Black)	2 cores (Brown/Blue)
	Outside diameter [mm]	ø1.1	
Conductor	Effective area [mm ²]	0.2	
	Strand diameter [mm]	ø0.08	
Minimum bending radius [mm] (Reference values)		21	

Note 1) Refer to page 932 for solid state auto switch common specifications.
Note 2) Refer to page 932 for lead wire lengths.

Weight

(g)

Auto switch model		D-F7NWV	D-F7BWV
Lead wire length	0.5 m (NII)	13	11
	3 m (L)	57	50
	5 m (Z)	92	81

Dimensions

(mm)

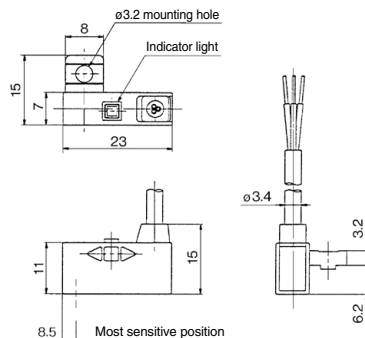

2-Color Indicator Solid State Auto Switch Tie-rod Mounting Type D-F59W/D-F5PW/D-J59W



Grommet

The proper operating range can be determined by the color of the light.
(Red → Green ← Red)



Refer to SMC website for the details of the products conforming to the international standards.

Auto Switch Specifications

PLC: Programmable Logic Controller

D-F5□W, D-J59W (With indicator light)			
Auto switch model	D-F59W	D-F5PW	D-J59W
Wiring type	3-wire		2-wire
Output type	NPN	PNP	—
Applicable load	IC circuit, Relay, PLC		24 VDC Relay, PLC
Power supply voltage	5, 12, 24 VDC (4.5 to 28 VDC)		—
Current consumption	10 mA or less		—
Load voltage	28 VDC or less	—	24 VDC (10 to 28 VDC)
Load current	40 mA or less	80 mA or less	5 to 40 mA
Internal voltage drop	1.5 V or less (0.8 V or less at 10 mA load current)	0.8 V or less	4 V or less
Leakage current	100 μA or less at 24 VDC		0.8 mA or less at 24 VDC
Indicator light	Operating range Red LED illuminates. Proper operating range Green LED illuminates.		
Standard	CE/UKCA marking		

Oilproof Heavy-duty Lead Wire Specifications

Auto switch model		D-F59W	D-F5PW	D-J59W
Sheath	Outside diameter [mm]	ø4		
	Number of cores	3 cores (Brown/Blue/Black)		2 cores (Brown/Blue)
Insulator	Outside diameter [mm]	ø1.22		
	Effective area [mm ²]	0.3		
Conductor	Strand diameter [mm]	ø0.08		
	Minimum bending radius [mm] (Reference values)	24		

Note 1) Refer to page 932 for solid state auto switch common specifications.
Note 2) Refer to page 932 for lead wire lengths.

Weight

(g)

Auto switch model		D-F59W	D-F5PW	D-J59W
Lead wire length	0.5 m (NII)	23		21
	3 m (L)	81		71
	5 m (Z)	127		111

Dimensions

(mm)

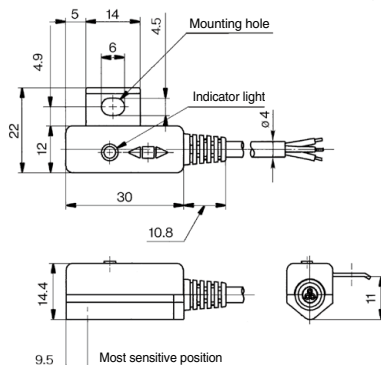

2-Color Indicator with Diagnostic Output Solid State Auto Switch: Rail Mounting Type D-F79F



Refer to SMC website for the details of the products conforming to the international standards.

Grommet

Since the diagnostic output signal can be detected in the red display area, the difference of detecting position can be confirmed by the side of PLC (Programmable Logic Controller).



Auto Switch Specifications

PLC: Programmable Logic Controller

D-F79F (With indicator light)	
Auto switch model	D-F79F
Wiring type	4-wire
Output type	NPN
Diagnostic output	Normal operation
Applicable load	IC circuit, Relay, PLC
Power supply voltage	5, 12, 24 VDC (4.5 to 28 VDC)
Current consumption	10 mA or less
Load voltage	28 VDC or less
Load current	50 mA or less at the total amount of normal output and diagnostic output
Internal voltage drop	1.5 V or less (0.8 V or less at 5 mA)
Leakage current	100 μ A or less at 24 VDC
Indicator light	Operating range Red LED illuminates. Proper operating range Green LED illuminates.
Standard	CE/UKCA marking

Oilproof Heavy-duty Lead Wire Specifications

Auto switch model		D-F79F
Sheath	Outside diameter [mm]	ϕ 3.4
Insulator	Number of cores	4 cores (Brown/Blue/Black/Orange)
	Outside diameter [mm]	ϕ 0.98
Conductor	Effective area [mm ²]	0.2
	Strand diameter [mm]	ϕ 0.08
Minimum bending radius [mm] (Reference values)		21

Note 1) Refer to page 932 for solid state auto switch common specifications.
Note 2) Refer to page 932 for lead wire lengths.

Weight

(g)

Auto switch model		D-F79F
Lead wire length	0.5 m (Nil)	13
	3 m (L)	56
	5 m (Z)	90

Diagnostic Output Operation

The diagnostic output signal is output within the red display area (where indicator light is Red), and it is not output within the proper operating range (where indicator light is Green). When the auto switch detecting position is not adjusted, the diagnostic output becomes activated.

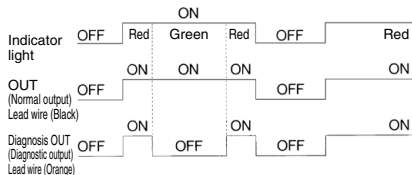

Dimensions

(mm)

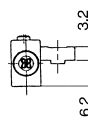
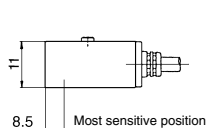
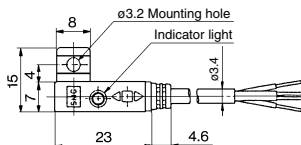

2-Color Indicator with Diagnostic Output Solid State Auto Switch: Tie-rod Mounting Type D-F59F



Refer to SMC website for the details of the products conforming to the international standards.

Grommet

Since the diagnostic output signal can be detected in the red display area, the difference of detecting position can be confirmed by the side of PLC (Programmable Logic Controller).



Auto Switch Specifications

PLC: Programmable Logic Controller

D-F59F (With indicator light)	
Auto switch model	D-F59F
Wiring type	4-wire
Output type	NPN
Diagnostic output	Normal operation
Applicable load	IC circuit, Relay, PLC
Power supply voltage	5, 12, 24 VDC (4.5 to 28 VDC)
Current consumption	10 mA or less
Load voltage	28 VDC or less
Load current	50 mA or less at the total amount of normal output and diagnostic output
Internal voltage drop	1.5 V or less (0.8 V or less at 5 mA)
Leakage current	100 μ A or less at 28 VDC
Indicator light	Operating range Red LED illuminates. Proper operating range Green LED illuminates.
Standard	CE/UKCA marking

Oilproof Heavy-duty Lead Wire Specifications

Auto switch model		D-F59F
Sheath	Outside diameter [mm]	ϕ 4
	Number of cores	4 cores (Brown/Blue/Black/Orange)
Insulator	Outside diameter [mm]	ϕ 1.29
	Effective area [mm ²]	0.3
Conductor	Strand diameter [mm]	ϕ 0.08
	Minimum bending radius [mm] (Reference values)	24

Note 1) Refer to page 932 for solid state auto switch common specifications.

Note 2) Refer to page 932 for lead wire lengths.

Weight

(g)

Auto switch model		D-F59F
Lead wire length	0.5 m (Nil)	22
	3 m (L)	77
	5 m (Z)	121

Diagnostic Output Operation

The diagnostic output signal is output within the red display area (where indicator light is Red), and it is not output within the proper operating range (where indicator light is Green). When the auto switch detecting position is not adjusted, the diagnostic output becomes activated.

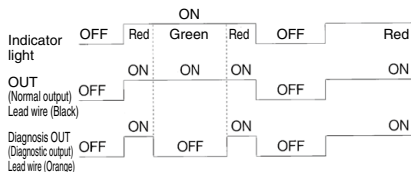

Dimensions

(mm)

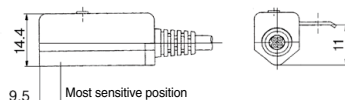
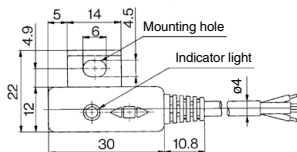

Water Resistant 2-Color Indicator Solid State Auto Switch: Direct Mounting Type

D-M9NA(V)/D-M9PA(V)/D-M9BA(V)



Grommet

- Water (coolant) resistant type
- 2-wire load current is reduced (2.5 to 40 mA).
- The proper operating range can be determined by the color of the light. (Red → Green ← Red)
- Using flexible cable as standard spec.



⚠ Caution

Precautions

Fix the auto switch with the existing screw installed on the auto switch body. The auto switch may be damaged if a screw other than the one supplied is used.
Please consult with SMC if using coolant liquid other than water based solution.

Weight

(g)

Auto switch model	D-M9NA(V)	D-M9PA(V)	D-M9BA(V)
Lead wire length			
0.5 m (Nil)	8	7	
1 m (M)	14	13	
3 m (L)	41	38	
5 m (Z)	68	63	

Dimensions

(mm)

D-M9□A

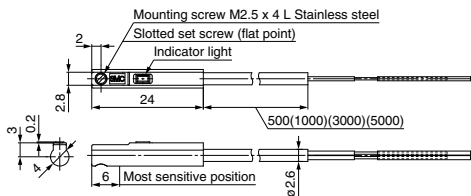

D-M9□AV

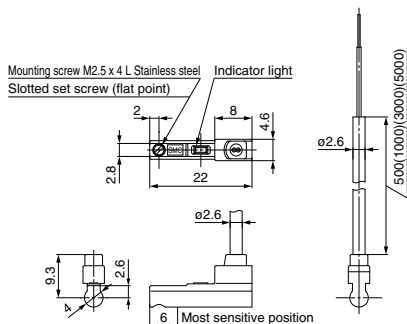

Auto Switch Specifications

PLC: Programmable Logic Controller

D-M9□A, D-M9□AV (With indicator light)						
Auto switch model	D-M9NA	D-M9NAV	D-M9PA	D-M9PAV	D-M9BA	D-M9BAV
Electrical entry direction	In-line	Perpendicular	In-line	Perpendicular	In-line	Perpendicular
Wiring type	3-wire			2-wire		
Output type	NPN		PNP		—	
Applicable load	IC circuit, Relay, PLC				24 VDC relay, PLC	
Power supply voltage	5, 12, 24 VDC (4.5 to 28 V)				—	
Current consumption	10 mA or less				—	
Load voltage	28 VDC or less		—		24 VDC (10 to 28 VDC)	
Load current	40 mA or less			2.5 to 40 mA		
Internal voltage drop	0.8 V or less at 10 mA (2 V or less at 40 mA)				4 V or less	
Leakage current	100 μA or less at 24 VDC				0.8 mA or less	
Indicator light	Operating range Red LED illuminates. Proper operating range Green LED illuminates.					
Standard	CE/UKCA marking					

Oilproof Flexible Heavy-duty Lead Wire Specifications

Auto switch model		D-M9NA□	D-M9NAV□	D-M9PA□	D-M9PAV□	D-M9BA□	D-M9BAV□
Sheath	Outside diameter [mm]	2.6					
Insulator	Number of cores	3 cores (Brown/Blue/Black)				2 cores (Brown/Blue)	
	Outside diameter [mm]	0.88					
Conductor	Effective area [mm ²]	0.15					
	Strand diameter [mm]	0.05					
Minimum bending radius [mm]		17					

Note 1) Refer to page 932 for solid state auto switch common specifications.

Note 2) Refer to page 932 for lead wire lengths.

Water Resistant 2-Color Indicator Solid State Auto Switch: Direct Mounting Type D-Y7BA



Refer to SMC website for the details of the products conforming to the international standards.

Grommet

- Water (coolant) resistant type
- Using flexible cable as standard spec.
- The proper operating range can be determined by the color of the light.
(Red → Green ← Red)



Caution

Precautions

Please consult with SMC if using coolant liquid other than water based solution. Detection characteristics (operating range) are the same as D-Y5□ and D-Y7□W, but the detection area length is different.

Auto Switch Specifications

PLC: Programmable Logic Controller

D-Y7BA (With indicator light)	
Auto switch model	D-Y7BA
Wiring type	2-wire
Applicable load	24 VDC Relay, PLC
Load voltage	24 VDC (10 to 28 VDC)
Load current	2.5 to 40 mA
Internal voltage drop	4 V or less
Leakage current	0.8 mA or less at 24 VDC
Indicator light	Operating range Red LED illuminates. Proper operating range Green LED illuminates.
Standard	CE/UKCA marking

Oilproof Flexible Heavy-duty Lead Wire Specifications

Auto switch model		D-Y7BA
Sheath	Outside diameter (mm)	ø3.4
	Number of cores	2 cores (Brown/Blue)
Insulator	Outside diameter (mm)	ø1
	Effective area (mm ²)	0.15
Conductor	Strand diameter (mm)	ø0.05
	Minimum bending radius (mm) (Reference values)	21

Note 1) Refer to page 932 for solid state auto switch common specifications.

Note 2) Refer to page 932 for lead wire lengths.

Weight

(g)

Auto switch model		D-Y7BA
Lead wire length	3 m (L)	54
	5 m (Z)	88

Dimensions

(mm)

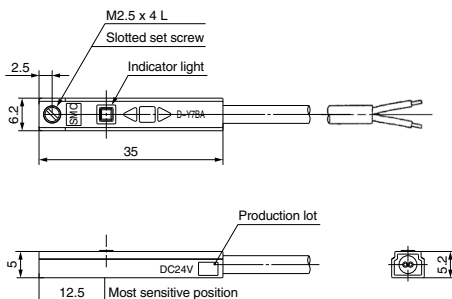

Water Resistant 2-Color Indicator Solid State Auto Switch: Rail Mounting Type D-F7BA(V)



Refer to SMC website for the details of the products conforming to the international standards.

Grommet

- Water (coolant) resistant type
- The proper operating range can be determined by the color of the light.
(Red → Green ← Red)



Caution

Precautions

Please consult with SMC if using coolant liquid other than water based solution.

Auto Switch Specifications

PLC: Programmable Logic Controller

D-F7BA(V) (With indicator light)		
Auto switch model	D-F7BA	D-F7BAV
Electrical entry direction	In-line	Perpendicular
Wiring type	2-wire	
Output type	—	
Applicable load	24 VDC Relay, PLC	
Power supply voltage	—	
Current consumption	—	
Load voltage	24 VDC (10 to 28 VDC)	
Load current	5 to 40 mA	
Internal voltage drop	4 V or less	
Leakage current	0.8 mA or less at 24 VDC	
Indicator light	Operating range Red LED illuminates. Proper operating range Green LED illuminates.	
Standard	CE/UKCA marking	

Oilproof Heavy-duty Lead Wire Specifications

Auto switch model		D-F7BA
Sheath	Outside diameter [mm]	ø3.4
	Number of cores	2 cores (Brown/Blue)
Insulator	Outside diameter [mm]	ø1.1
	Effective area [mm ²]	0.2
Conductor	Strand diameter [mm]	ø0.08
	Minimum bending radius [mm] (Reference values)	21

Note 1) Refer to page 932 for solid state auto switch common specifications.
Note 2) Refer to page 932 for lead wire lengths.

Weight

(g)

Auto switch model		D-F7BA	D-F7BAV
Lead wire length	3 m (L)	50	
	5 m (Z)		81

Dimensions

(mm)

D-F7BA

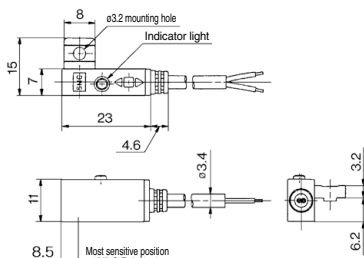

D-F7BAV

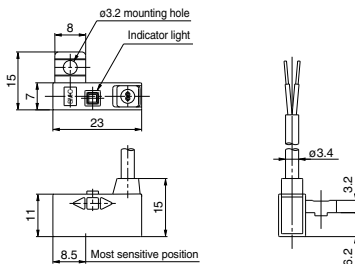

Water Resistant 2-Color Indicator Solid State Auto Switch: Tie-rod Mounting Type D-F5BA



Refer to SMC website for the details of the products conforming to the international standards.

Grommet

- Water (coolant) resistant type
- The proper operating range can be determined by the color of the light.
(Red → Green ← Red)



Caution

Precautions

Please consult with SMC if using coolant liquid other than water based solution.

Auto Switch Specifications

PLC: Programmable Logic Controller

D-F5BA (With indicator light)	
Auto switch model	D-F5BA
Wiring type	2-wire
Output type	—
Applicable load	24 VDC Relay, PLC
Power supply voltage	—
Current consumption	—
Load voltage	24 VDC (10 to 28 VDC)
Load current	5 to 40 mA
Internal voltage drop	4 V or less
Leakage current	0.8 mA or less at 24 VDC
Indicator light	Operating range Red LED illuminates. Proper operating range Green LED illuminates.
Standard	CE/UKCA marking

Oilproof Heavy-duty Lead Wire Specifications

Auto switch model		D-F5BA
Sheath	Outside diameter [mm]	ø4
	Number of cores	2 cores (Brown/Blue)
Insulator	Outside diameter [mm]	ø1.22
	Effective area [mm ²]	0.3
Conductor	Strand diameter [mm]	ø0.08
	Minimum bending radius [mm] (Reference values)	24

Note 1) Refer to page 932 for solid state auto switch common specifications.

Note 2) Refer to page 932 for lead wire lengths.

Weight

(g)

Auto switch model		D-F5BA
Lead wire length	3 m (L)	71
	5 m (Z)	111

Dimensions

(mm)

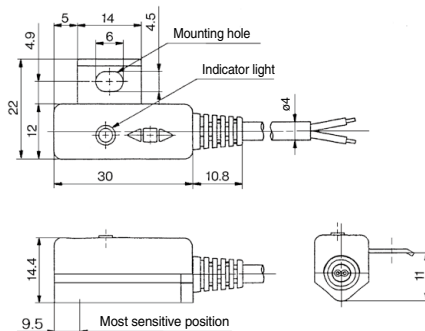

Solid State Auto Switch with Timer Rail Mounting Type D-F7NT



Refer to SMC website for the details of the products conforming to the international standards.

Grommet

- With built-in OFF-delay timer (approx. 200 ms)
- Easy intermediate detection



Auto Switch Specifications

PLC: Programmable Logic Controller

D-F7NT (With indicator light)	
Auto switch model	D-F7NT
Wiring type	3-wire
Output type	NPN
Output operation	Off-delay
Operating time	1 ms or less
Off-delay time	200 ± 50 ms
Applicable load	IC circuit, Relay, PLC
Power supply voltage	5, 12, 24 VDC (4.5 to 28 VDC)
Current consumption	10 mA or less
Load voltage	28 VDC or less
Load current	40 mA or less
Internal voltage drop	1.5 V or less (0.8 V or less at 10 mA)
Leakage current	100 µA or less at 24 VDC
Indicator light	Red LED illuminates when turned ON.
Standard	CE/UKCA marking

Oilproof Heavy-duty Lead Wire Specifications

Auto switch model		D-F7NT
Sheath	Outside diameter [mm]	ø3.4
Insulator	Number of cores	3 cores (Brown/Blue/Black)
	Outside diameter [mm]	ø1.1
Conductor	Effective area [mm ²]	0.2
	Strand diameter [mm]	ø0.08
Minimum bending radius [mm] (Reference values)		21

Note 1) Refer to page 932 for solid state auto switch common specifications.
Note 2) Refer to page 932 for lead wire lengths.

Weight

(g)

Auto switch model		D-F7NT
Lead wire length	3 m (L)	57
	5 m (Z)	92

Timer Operation

Detection of intermediate positioning for high-speed cylinder

Detecting point dispersion occurs due to response time of PLC (sequencer); e.g. scanning.

Ex.) Cylinder speed — 1000 mm/sec.
PLC response time — 0.1 sec.
Detecting point dispersion — Within 100 mm (= 1000 mm/sec. x 0.1 sec.)

Take PLC response time into consideration when using.

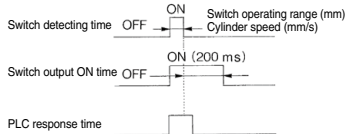

Dimensions

(mm)

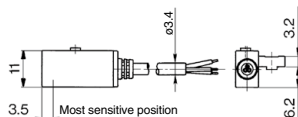
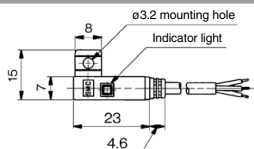

Solid State Auto Switch with Timer Tie-rod Mounting Type D-F5NT



Refer to SMC website for the details of the products conforming to the international standards.

Grommet

- With built-in OFF-delay timer (approx. 200 ms)
- Easy intermediate detection



Auto Switch Specifications

PLC: Programmable Logic Controller

D-F5NT (With indicator light)	
Auto switch model	D-F5NT
Wiring type	3-wire
Output type	NPN
Output operation	Off-delay
Operating time	1 ms or less
Off-delay time	200 ± 50 ms
Applicable load	IC circuit, Relay, PLC
Power supply voltage	5, 12, 24 VDC (4.5 to 28 VDC)
Current consumption	10 mA or less
Load voltage	28 VDC or less
Load current	40 mA or less
Internal voltage drop	1.5 V or less (0.8 V or less at 10 mA)
Leakage current	100 μA or less at 24 VDC
Indicator light	Red LED illuminates when turned ON.
Standard	CE/UKCA marking

Oilproof Heavy-duty Lead Wire Specifications

Auto switch model		D-F5NT
Sheath	Outside diameter [mm]	ø4
	Number of cores	3 cores (Brown/Blue/Black)
Insulator	Outside diameter [mm]	ø1.22
	Effective area [mm ²]	0.3
Conductor	Strand diameter [mm]	ø0.08
	Minimum bending radius [mm] (Reference values)	24

Note 1) Refer to page 932 for solid state auto switch common specifications.
Note 2) Refer to page 932 for lead wire lengths.

Timer Operation

Detection of intermediate positioning for high-speed cylinder

Detecting point dispersion occurs due to response time of PLC (sequencer); e.g. scanning.

Ex.) Cylinder speed — 1000 mm/sec.
PLC response time — 0.1 sec.
Detecting point dispersion — Within 100 mm (= 1000 mm/sec. x 0.1 sec.)
Take PLC response time into consideration when using.

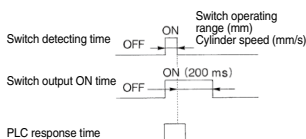

Weight

(g)

Auto switch model		D-F5NT
Lead wire length	3 m (L)	81
	5 m (Z)	127

Dimensions

(mm)

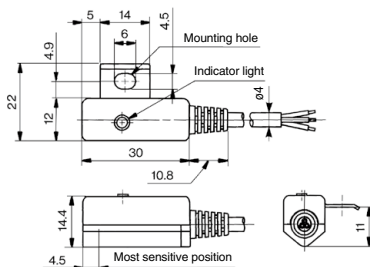

Trimmer Auto Switch

D-M9K/D-□7K/D-R□K Series

One auto switch allows work pieces to be distinguished easily.



RoHS

Minimum adjustment width to detect

0.5 mm

With one switch, various sized work pieces can be detected by the difference of 0.5 mm or more.
 * From 0.5 mm to detectable width dependant on applied actuator.

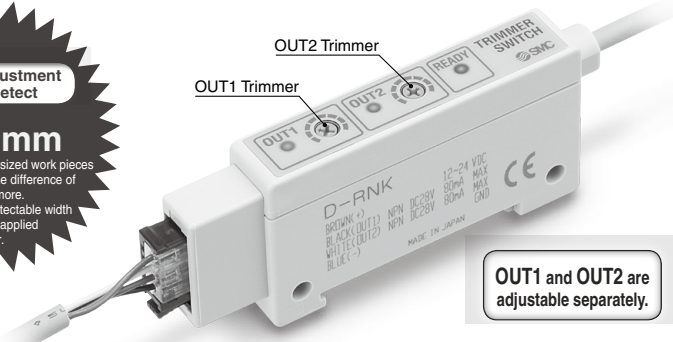

OUT1 and OUT2 are adjustable separately.

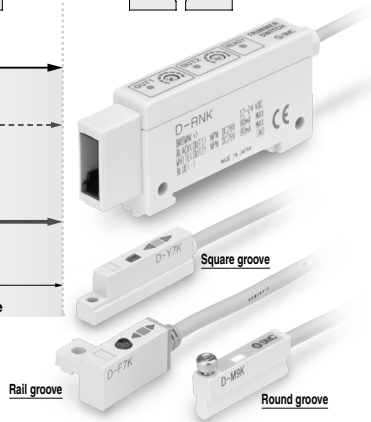
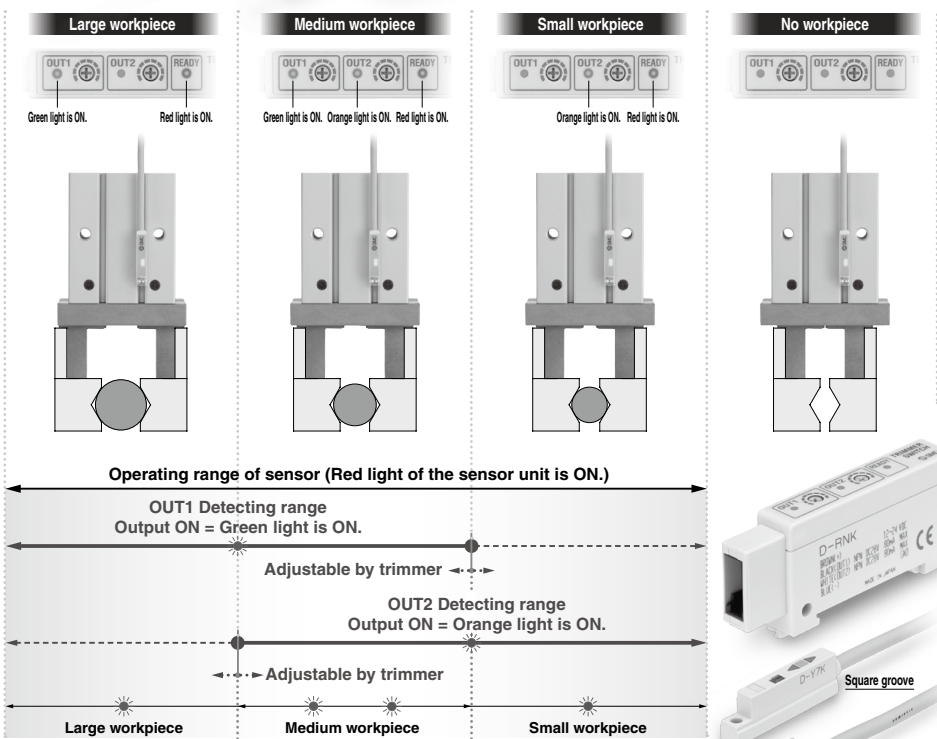

Applicable to the short stroke cylinder.

Only one auto switch can detect the extended and retracted end positions. This switch can be used when two auto switches cannot be mounted due to short stroke.

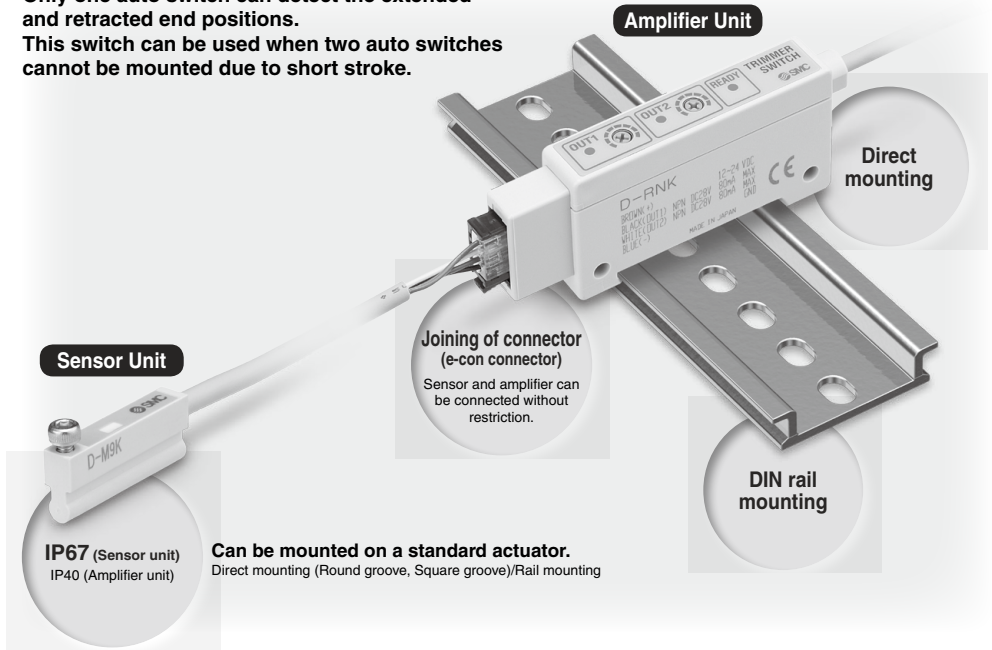

Examples

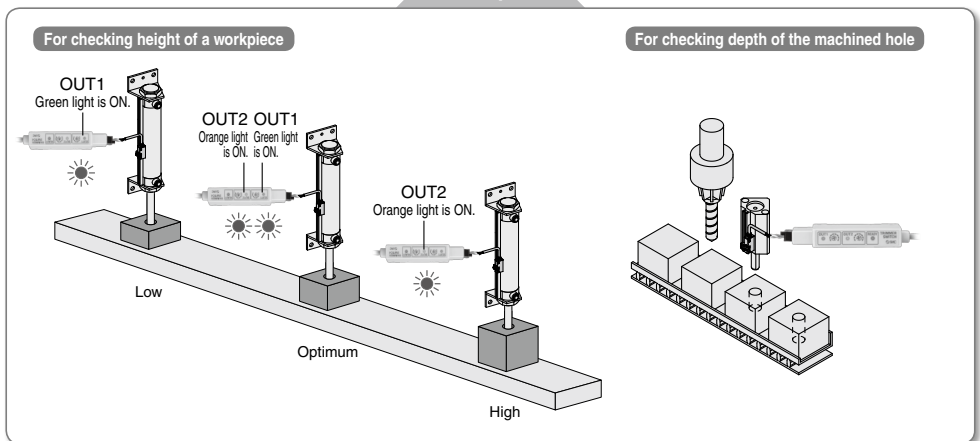

Trimmer Auto Switch



D-M9K/D-□7K/D-R□K Series

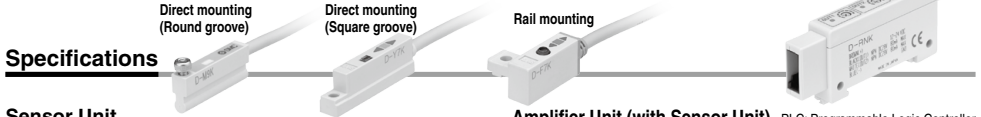

Specifications

Sensor Unit

Auto switch model	D-M9K	D-Y7K	D-F7K
Mounting	Direct mounting (Round groove)	Direct mounting (Square groove)	Rail mounting
Applicable amplifier unit	D-RNK, D-RPK		
Indicator lamp	Red lights ON at sensitive position. Green lights ON at optimum detecting position.		
Electrical entry	Grommet		
Impact resistance	980 m/s ²		
Insulation resistance	50 MΩ or more (500 VDC measured via megohmmeter) between lead wire and case		
Withstand voltage	1000 VAC for 1 minute (between lead wire and case)		
Ambient temperature	-10 to 60°C		
Enclosure	IP67		
Weight (with connector)	55 g		58 g
Standard	CE/UKCA Marking		

Oilproof Heavy-duty Cable

Auto switch model	D-M9K	D-Y7K	D-F7K
Sheath	Outside diameter [mm]	φ3.5	
Insulator	Number of cores	4 cores (Brown/Blue/Black/White)	
	Outside diameter [mm]	φ1.0	
Conductor	Effective area [mm ²]	0.15 (AWG26)	
	Strand diameter [mm]	φ0.08	
Minimum bending radius [mm] (Reference value)		21	

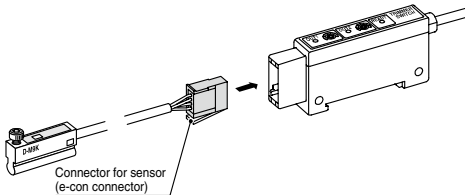

(Note) The connector for sensor (e-con connector) is not attached to the lead wire. It will be supplied loose in the same shipment (1 pc.).

Internal Circuit

Sensor Unit

D-M9K/D-□7K

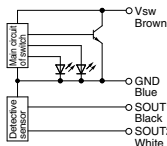

Amplifier Unit

D-RNK

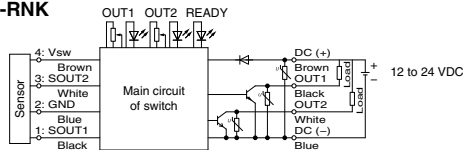

D-RPK

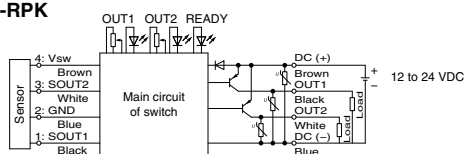

D-M9K/D-□7K/D-R□K Series

Values which include hysteresis are for guideline purposes only, they are not a guarantee (assuming approximately ±30% dispersion) and may change substantially depending on the ambient environment. Please consult with SMC for alternative actuators other than those shown below.

Applicable Actuators and Operating Range (Angle)

Sensor Unit D-M9K



Air Grippers (The operating range for grippers is measured when both ends are open.)

Description/Series		Bore size											
		10	16	20	25	32	40	50	63	80	100	125	
Parallel type	MHZ2	—	3.5	5.5	6.0	7.5	8.0	—	—	—	—	—	—
Parallel type	MHZL2	—	3.5	5.5	6.0	—	—	—	—	—	—	—	—
Parallel type	MHZJ2	—	5.0	6.0	6.0	—	—	—	—	—	—	—	—
Parallel type	MHS2 (2 fingers)	—	—	4.0	4.5	*						—	—
Parallel type	MHS3 (3 fingers)	—	—	4.0	4.5	*						—	—
Parallel type	MHS4 (4 fingers)	—	—	4.0	4.5	*						—	—

* When using the MHS series (bore size ø32 or more), use the D-Y7K.

Air Cylinders

Description/Series		Bore size														
		12	16	20	25	32	40	50	63	80	100	125	140	160	180	200
Compact cylinder	CQ2 [*]	3.0	4.0	4.0	4.0	4.5	4.0	4.5	5.0	5.0	6.0	6.5	6.5	6.0	6.0	6.0
Compact cylinder guide rod type	CQM	2.5	3.0	4.0	3.5	4.5	4.0	4.5	5.0	5.0	6.0	—	—	—	—	—
3 position cylinder	RZQ	—	—	—	—	4.5	4.0	4.5	5.0	—	—	—	—	—	—	—
Rotary clamp cylinder	MK	2.5	3.5	3.5	4.0	4.5	4.0	4.5	4.5	—	—	—	—	—	—	—
Compact guide cylinder	MGP-Z	3.0	4.0	4.0	4.0	4.5	4.0	4.0	4.5	4.5	5.0	—	—	—	—	—

* Excludes the axial piping type (CQP2), compact cylinder with end lock (CBQ2), and the low-speed cylinder (CQ2X)

Sensor Unit D-Y7K



Air Grippers (The operating range for grippers is measured when both ends are open.)

Description/Series		Bore size											
		10	12	16	20	25	32	40	50	63	80	100	
Parallel type	MHZ2	3.0	—	5.0	7.0	7.0	8.0	8.5	—	—	—	—	—
Parallel type	MHZL2	6.0	—	7.0	10.0	11.0	—	—	—	—	—	—	—
Wide type	MHL2	7.0	—	8.0	8.5	10.5	11.0	12.5	—	—	—	—	—
Parallel type	MHS2 (2 fingers)	—	—	—	—	—	6.5	7.0	7.5	8.5	—	—	—
Parallel type	MHS3 (3 fingers)/MHS(L)3	—	—	—	—	—	6.5	7.0	7.5	8.0	—	—	—
Parallel type	MHS4 (4 fingers)	—	—	—	—	—	6.5	7.0	7.5	8.5	—	—	—
Angular type	MHC2	30° to -10°	—	30° to -10°	30° to -10°	22.5° to -10°	—	—	—	—	—	—	—
180° Angular type	MHW2	—	—	—	88° to -5°	54° to -6°	58° to -5°	41° to -5°	30° to -4°	—	—	—	—

Air Cylinders

Description/Series		Bore size							
		20	25	32	40	50	63	80	100
Compact guide cylinder	MGP [*]	4.5	4.5	5.5	5.5	5.5	5.5	5.5	6.0
Non-rotating double power cylinder	MGZ	—	—	—	5.5	6.5	6.5	—	—
Air cylinder	CA2	—	—	—	4.0	4.0	6.0	6.0	6.0

* Only the cylinder with end lock (MGP-H/R) and the heavy duty guide rod type (MGPS)

Sensor Unit D-F7K



Air Cylinders

Description/Series		Bore size											
		10	12	16	20	25	32	40	50	63	80	100	
Air cylinder	CJ2	4.0	—	4.5	—	—	—	—	—	—	—	—	—
Air cylinder	CM2 ^{*1}	—	—	—	3.5	3.5	3.5	3.5	—	—	—	—	—
Compact cylinder	CQ2 ^{*2}	—	4.5	5.5	5.5	5.0	5.5	5.5	5.5	6.0	5.5	6.0	6.0
Plate cylinder	MU	—	—	—	—	5.5	6.5	6.5	6.5	6.5	—	—	—
Rotary clamp cylinder	MK2T	—	—	—	5.0	5.0	6.5	6.0	6.0	6.5	—	—	—

*1 Use the Made-to-Order product (-XC13: Auto switch rail mounting type) for the CM2 series.

*2 The axial piping type (CQP2), compact cylinder with end lock (CBQ2), and the low-speed cylinder (CQ2X) are not applicable.

Trimmer Auto Switch **D-M9K/D-□7K/D-R□K Series**

Dimensions

Sensor Unit

D-M9K

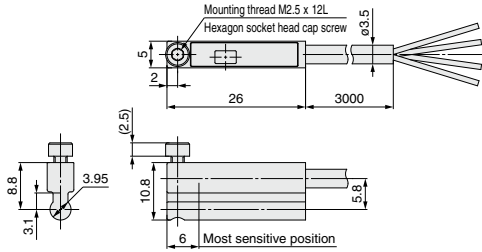

D-Y7K

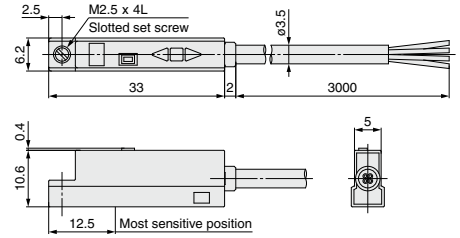

D-F7K

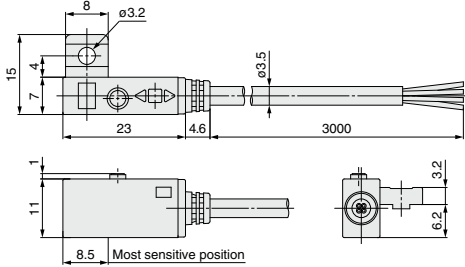

Amplifier Unit

D-R□K

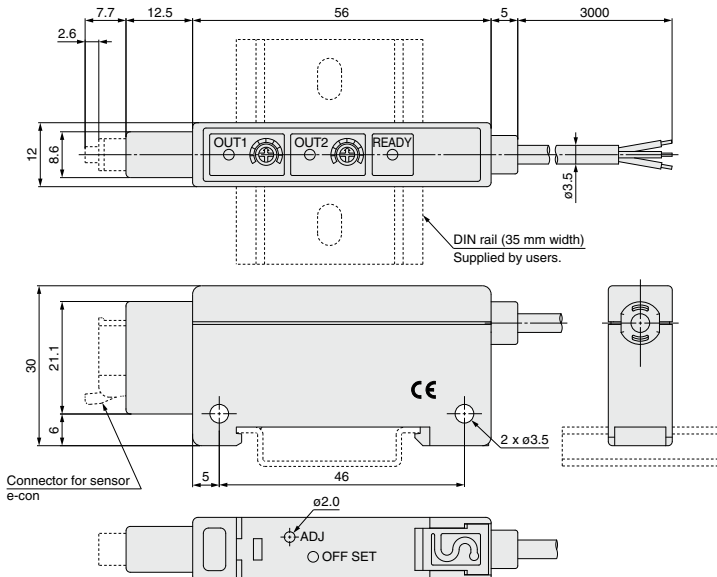

D-M9K/D-□7K/D-R□K Series

How to Mount and Move the Auto Switch

D-M9K **Mounting Bracket** Direct Mounting Type

<Applicable auto switch>

Solid state.....D-M9K

Applicable Actuators

Air Grippers

Description	Series	Bore size
Parallel type	MHZ2	16 to 40
Parallel type	MHZL2	16 to 25
Parallel type	MHZJ2	16 to 25
Parallel type	MHS2 (2 fingers)	20, 25
Parallel type	MHS3 (3 fingers)	20, 25
Parallel type	MHS4 (4 fingers)	20, 25

Air Cylinders

Description	Series	Bore size
Compact cylinder	CQ2*	12 to 200
Compact cylinder guide rod type	CQM	12 to 100
3 position cylinder	RZQ	32 to 63
Rotary clamp cylinder	MK	12 to 63
Compact guide cylinder	MGP-Z	12 to 100

How to Mount and Move the Auto Switch

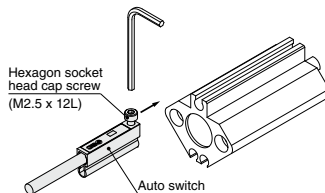

Note) The tightening torque for a hexagon socket head cap screw (M2.5 x 12L) is 0.1 to 0.2 N·m.

* Excludes the axial piping type (CQP2), compact cylinder with end lock (CBQ2), and the low-speed cylinder (CQ2X)

D-Y7K **Mounting Bracket** Direct Mounting Type

<Applicable auto switch>

Solid state.....D-Y7K

Applicable Actuators

Air Grippers

Description	Series	Bore size
Parallel type	MHZ2	10 to 40
Parallel type	MHZL2	10 to 25
Wide type	MHL2	10 to 40
Parallel type	MHS2 (2 fingers)	32 to 63
Parallel type	MHS3 (3 fingers)/MHS(L)3	32 to 63
Parallel type	MHS4 (4 fingers)	32 to 63
Angular type	MHC2	10 to 25
180° Angular type	MHW2	20 to 50

Air Cylinders

Description	Series	Bore size
Non-rotating double power cylinder	MGZ	40 to 63
Compact guide cylinder	MGP*	20 to 100

* Only the cylinder with end lock (MGP-H/R) and the heavy duty guide rod type (MGPS)

How to Mount and Move the Auto Switch (2)

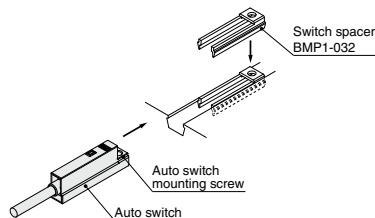

1. After picking up a switch spacer between your fingers, push it in the cylinder tube groove.
2. Confirm that it is set in the correct mounting orientation.

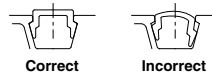

3. Insert the auto switch into the mounting groove and set it at the auto switch mounting position.
4. After reconfirming the detecting position, tighten the mounting screw to secure the auto switch.

Note) When tightening an auto switch mounting screw, use a watchmaker's screwdriver with a grip diameter of 5 to 6 mm. Also, tighten with a torque of about 0.05 to 0.1 N·m
As a guide, it should be turned about 90° past the point at which tightening can be felt.

Auto Switch Mounting Bracket/Part No. (Switch spacer and auto switch mounting bracket)

Cylinder series	Bore size		
	40	50	63
MGZ	BMP1-032	BMP1-032	BMP1-032

How to Mount and Move the Auto Switch (1)

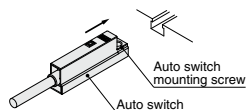

1. Insert the auto switch into the mounting groove and set it at the auto switch mounting position.
2. After reconfirming the detecting position, tighten the mounting screw to secure the auto switch.
3. Modification of the detecting position should be made in the condition of 1.

Note) When tightening an auto switch mounting screw, use a watchmaker's screwdriver with a grip diameter of 5 to 6 mm. Also, tighten with a torque of about 0.05 to 0.1 N·m
As a guide, it should be turned about 90° past the point at which tightening can be felt.

How to Mount and Move the Auto Switch

D-F7K **Mounting Bracket** Rail Mounting Type

<Applicable auto switch>

Solid state.....D-F7K

Applicable Actuators

Description	Series	Bore size
Air cylinder	CJ2	10, 16
Air cylinder	CM2	20 to 40
Compact cylinder	CQ2	12 to 100
Plate cylinder	MU	25 to 63
Rotary clamp cylinder	MK2T	20 to 63

How to Mount and Move the Auto Switch

- Slide the auto switch mounting nut inserted into the mounting rail and set it at the auto switch mounting position.
- Fit the convex part of auto switch mounting arm into the concave part of auto switch mounting rail. Then, slide the switch over the nut.
(CDQ2 series: Fit the convex part of auto switch mounting arm through the auto switch spacer into the concave part of auto switch mounting rail.)
- Push the auto switch mounting screw lightly into the mounting nut through the hole of auto switch mounting arm.
- After reconfirming the detecting position, tighten the mounting screw to secure the auto switch. (Tightening torque of M3 screw should be 0.5 to 0.7 N·m.)
- Modification of the detecting position should be made in the condition of 3.

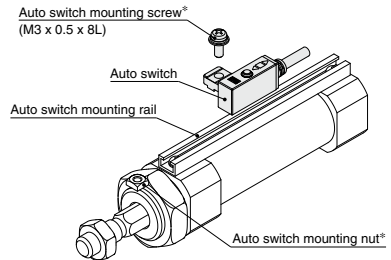

* When the CJ2 (rail mounting type) and the CM2-XC13 cylinders are ordered, nuts and screws are included.

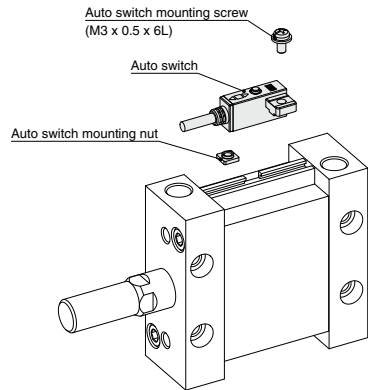

Auto Switch Mounting Bracket Part No. (Including Nut, Screw, (Spacer))

Cylinder series	Bore size									
	12	16	20	25	32	40	50	63	80	100
CQ2 *	BQ-1	BQ-1	BQ-1	BQ-1	BQ-2	BQ-2	BQ-2	BQ-2	BQ-2	BQ-2
MU	—	—	—	BMU1-025	BMU1-025	BMU1-025	BMU1-025	BMU1-025	—	—
MK2T	—	—	BQ-1	BQ-1	BQ-2	BQ-2	BQ-2	BQ-2	—	—

* Only the axial piping type (CQP2), compact cylinder with end lock (CBQ2), and the low-speed cylinder (CQ2X) can be used.

D-M9K/D-□7K/D-R□K Series

How to Mount and Move the Auto Switch

D-Y7K **Mounting Bracket** Tie-rod Mounting Type

<Applicable auto switch>

Solid state..... D-Y7K

Applicable Actuators

Air Cylinder

Description	Series	Bore size
Air cylinder	CA2	40 to 100

How to Mount and Move the Auto Switch

1. Fix it to the detecting position with a set screw by installing an auto switch mounting bracket in cylinder tie-rod and letting the bottom surface of an auto switch mounting bracket contact the cylinder tube firmly. Fix it to the detecting position with a set screw. (Use a hexagon wrench.)
2. Fit an auto switch into the auto switch mounting groove to set it roughly to the mounting position for an auto switch.
3. After confirming the detecting position, tighten up the mounting screw attached to an auto switch, and secure the auto switch.
4. When changing the detecting position, carry out in the state of 2.

* To protect auto switches, ensure that main body of an auto switch should be embedded into auto switch mounting groove with a depth of 15 mm or more.

Auto Switch Mounting Bracket Part No. (Including Bracket, Set Screw)

Cylinder series	Bore size				
	40	50	63	80	100
CA2	BA4-040	BA4-040	BA4-063	BA4-080	BA4-080

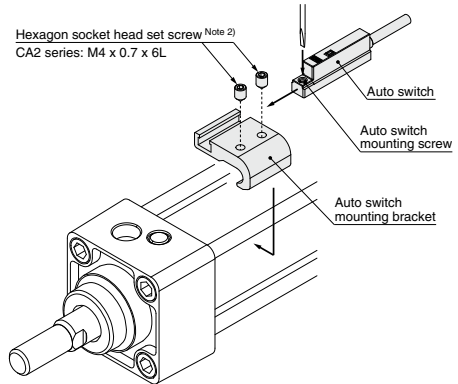

Note 1) When tightening an auto switch mounting screw, use a watchmaker's screwdriver with a grip diameter of 5 to 6 mm. Also, set the tightening torque to be 0.05 to 0.1 N·m. As a guide, turn 90° from the position where it comes to feel tight.

Note 2) Set the tightening torque of a hexagon socket head set screw (M4 x 0.7) to be 1 to 1.2 N·m.



Trimmer Auto Switch Specific Product Precautions

Be sure to read this before handling the products. Refer to page 7 for safety instructions and pages 18 to 22 for auto switch precautions.

Design and Selection

Warning

1. Check the specifications.

Read the specifications carefully and use this product appropriately. The product may be damaged or malfunction if it is used outside the range of specifications of current load, voltage, temperature or impact.

2. Cautions for use in an interlock circuit

When an auto switch is used for an interlock signal requiring high reliability, devise a double interlock system to avoid trouble by providing a mechanical protection function, or by also using another switch (sensor) together with the trimmer auto switch. Also, perform periodic maintenance and confirm proper operation.

Caution

1. Take precautions when multiple cylinders are used close together.

When 2 or more cylinders with trimmer auto switches are used in close proximity, maintain a minimum actuator interval of 40 mm or more. (When the allowable interval is indicated for each cylinder series, use the specified values.) Magnetic field interference may cause the trimmer auto switches to malfunction.

2. Keep the wiring as short as possible.

Use a wire 3 m or shorter between the sensor and amplifier. If the sensor cable length exceeds 3 m, the CE/UKCA marking does not apply to the auto switch. Although wire length of power supply/output cable should not affect switch function, use a wire 100 m or shorter.

3. Take precautions for the internal voltage drop of the switch.

Auto switches may not operate properly depending on the connected equipment.

4. Take measures for rotational stoppage of the piston rod.

Take measures for rotational stoppage of the piston rod when designing by guide etc. Or use non-rotating type SMC products. The operation may be unstable.

Mounting and Adjustment

Caution

1. Do not drop or bump.

Do not drop, bump or apply excessive impacts (980 m/s² or more for sensor unit and 98 m/s² or more for amplifier unit) while handling. Although the trimmer auto switch body may not be damaged, the inside of the trimmer auto switch could be damaged and cause a malfunction.

2. Refer to the Operation Manual for how to adjust/set.

Wiring

Caution

1. Avoid repeatedly bending or stretching lead wires.

Broken lead wires will result from applying bending stress or stretching forces to the lead wires.

2. Be sure to connect the connector for sensor to the amplifier before power is applied.

3. Do not allow short circuit of loads.

Output is automatically stopped when the protection circuit is working, as the output unit registers any excess current flow, if loads are short circuited. Should this occur, shut off the power supply, remove the cause of this excess current flow and switch on the power again. Take special care to avoid reverse wiring between the power supply line (brown) and the output line (black, white).

Wiring

Caution

4. Avoid incorrect wiring.

If the connections are reversed (power supply line + and power supply line -), the trimmer auto switches will be protected by a protection circuit. However, if the power supply line (-) is connected to the black, white wire, the trimmer auto switches will be damaged.

Operating Environment

Warning

1. Never use in an atmosphere with explosive gases.

The structure of trimmer auto switches is not designed to prevent explosion. Never use in an atmosphere with an explosive gas since this may cause a serious explosion.

Caution

1. Do not use in an area where a magnetic field is generated.

Trimmer auto switches will malfunction or magnets inside actuators will become demagnetized.

2. Do not use in an environment where the trimmer auto switch will be continually exposed to water.

Although the sensor units of trimmer auto switches satisfy the IEC standard IP67 structure, do not use trimmer auto switches in applications where continually exposed to water splash or spray. Poor insulation or swelling of the potting resin inside trimmer auto switches may cause a malfunction. (Amplifier unit D-RNK and RPK: IP40)

3. Do not use in an environment with oil or chemicals.

Please consult with SMC if trimmer auto switches will be used in an environment with coolant, cleaning solvent, various oils or chemicals. If trimmer auto switches are used under these conditions for even a short time, they may be adversely affected by improper insulation, malfunction due to swelling of the potting resin, or hardening of the lead wires.

4. Take measures against freezing when operating at 5°C or less.

Maintenance

Warning

1. Perform the following maintenance periodically in order to prevent possible danger due to unexpected trimmer auto switch malfunction.

- Secure and tighten trimmer auto switch mounting screws. If screws become loose or the mounting position is dislocated, retighten them after readjusting the mounting position.
- Confirm that there is no damage to lead wires. To prevent faulty insulation, replace trimmer auto switches or repair lead wires, etc., if damage is discovered.

Other

Caution

1. Please consult with SMC concerning water resistance, elasticity of lead wires, and usage at welding sites, etc.

Made to Order Specifications: Solid State Auto Switch



Refer to SMC website for the details of the products conforming to the international standards.

1 With Pre-wired Connector

- Eliminates the harnessing work by cable with connector specifications
- Adopts global standardized connector (IEC61076-2)
- IP67 construction



How to Order

D-M9NSAPC

Solid state auto switch
Standard part no.

* For the applicable auto switch model, refer to the table below.

Cable length

S	0.5 m
M	1.0 m

Connector model

A	M8-3 pin
B	M8-4 pin
D	M12-4 pin

Note) Type A is not selectable for the auto switch with diagnostic output.

Connector Specifications

Connector model	M8-3 pin	M8-4 pin	M12-4 pin
Pin arrangement			
Conformed standard	IEC61076-2-104		IEC61076-2-101
Impact resistance	300 m/s ²		
Enclosure	Only with screw tightened IP67 (IEC60529 standard)		
Insulation resistance	100 MΩ or more at 500 VDC measured via megohmmeter		
Withstand voltage	1500 VAC 1 minute (between contacts), Leak current 1 mA or less		

Applicable Auto Switch

For details on the D-P3DWA series magnetic field resistant auto switch and the D-P4DW series, refer to the [Web Catalog](#).

2-wire

Mounting	Function	Applicable model
Rail mounting type	—	J79, F7BV
	2-color indicator	J79W, F7BWV
	Water resistant	F7BA, F7BAV
Band mounting type	—	H7B
	—	K59
	2-color indicator	H7BW
	—	K59W
	Water resistant	H7BA
Tie-rod mounting type	—	J59
	2-color indicator	J59W
	Water resistant	F5BA
Direct mounting type	—	Y59B, Y69B
	—	M9B, M9BV
	—	F8B
	Normally closed	M9BE, M9BEV
	2-color indicator	Y7BW, Y7BWV
	—	M9BW, M9BWV
	Water resistant	Y7BA
	Water resistant	M9BA, M9BAV
	Hygienic	F6B
	Rotary actuator	—
—		T991/2, T99V1/2

3-wire

Mounting	Function	Applicable model
Rail mounting type	—	F79, F7P, F7NV, F7PV
	2-color indicator	F79W, F7PW, F7NWV
	With timer	F7NT
Band mounting type	—	H7A1, H7A2
	—	G59, G5P
	2-color indicator	H7NW, H7PW
	—	G59W, G5PW
	With timer	G5NT
Tie-rod mounting type	—	F59, F5P
	2-color indicator	F59W, F5PW
	With timer	F5NT
Direct mounting type	—	Y59A, Y7P, Y69A, Y7PV
	—	M9N, M9P, M9NV, M9PV
	—	F8N, F8P
	—	Y7G, Y7H
	—	F9G, F9H
	Normally closed	M9NE, M9PE, M9NEV, M9PEV
	2-color indicator	Y7NW, Y7PW, Y7NWV, Y7PWV
	—	M9NW, M9PW, M9NWV, M9PWV
	Water resistant	M9NA, M9NAV, M9PA, M9PAV
	Hygienic	F6N, F6P
Rotary actuator	—	S791/2, S7P1/2
	—	S991/2, S9P1/2, S99V1/2

4-wire

Mounting	Function	Applicable model
Rail mounting type	Direct mounting type	F79F
Band mounting type		H7NF
Tie-rod mounting type		G59F
		F59F

Note) M8-3 pins are not selectable for the 4-wire auto switch.

Connector pin arrangement

Sensor type	Meaning of contact number			
	1 pin	2 pin	3 pin	4 pin
2-wire	OUT(+)	—	—	OUT(-)
3-wire	DC(+)	—	DC(-)	OUT
4-wire	DC(+)	Diagnostic output	DC(-)	OUT

Note1) For details on the D-P3DWASC, D-P3DWASE, D-P4DWSC and D-P4DWSE, refer to the [Web Catalog](#).

Note2) For details on the pin arrangement, refer to the pin arrangement in the connector specifications above.

With Pre-wired Connector

Dimensions



M8-3 pin



M8-4 pin



M12-4 pin

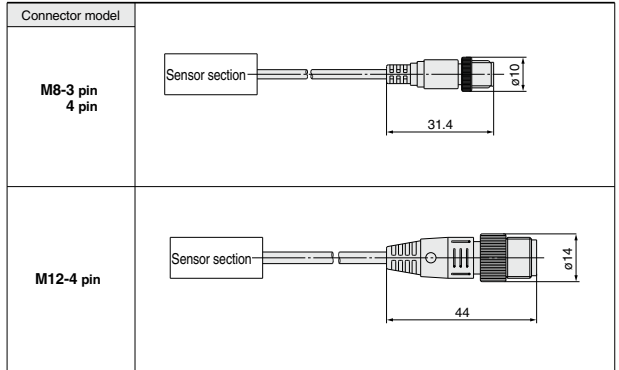

Connection (Socket side) Connector Cable

As the parts are not supplied from SMC, refer to the application examples listed in the below.
(For detail such as catalog availability, etc., please contact each manufacturer.)

Connector size	Number of pins	Manufacturer	Applicable series example
M8	3	OMRON Corporation	XS3□
		PHOENIX CONTACT GmbH & Co. KG	SAC-3P□
		Correns Corporation	M8-3D□
		TE Connectivity Ltd.	T40
	4	Hans Turck GmbH & Co. KG	PKG3M□
		OMRON Corporation	XS3□
		PHOENIX CONTACT GmbH & Co. KG	SAC-4P□
		Correns Corporation	M8-3D□
M12	3	TE Connectivity Ltd.	T40
		Hans Turck GmbH & Co. KG	PKG4M□
		OMRON Corporation	XS2□, XS5□
		PHOENIX CONTACT GmbH & Co. KG	SAC-4P□
	4	Correns Corporation	VA-4D□
		TE Connectivity Ltd.	T41
		Hans Turck GmbH & Co. KG	RKC4.4□
		Azbil Corporation	PA5-4I
		DDK Ltd.	CM02B

Weight for Connector Type

Part no.	Connector type	Weight
D-□□□APC	M8-3 pin	4 g
D-□□□BPC	M8-4 pin	4 g
D-□□□DPC	M12-4 pin	About 11 g

Made to Order Specifications: Solid State Auto Switch

-50: Without Indicator Light (Dark room) Specifications

-61: Oilproof Flexible Heavy-duty Cord Specifications

2 Without Indicator Light (for dark room specifications)

Symbol

-50

Possible to use under the environment which hates a light.

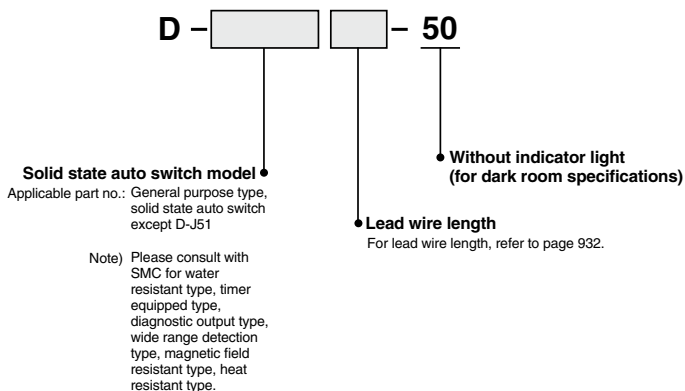

Dimensions and specifications are common as standard products with the exception of no indicator light.

3 Oilproof Flexible Heavy-duty Cord Specifications

Symbol

-61

This is the product which uses a heavy-duty cord having flexible characteristics 5 times (SMC comparison) as strong as oilproof heavy-duty cord used in the standard products.

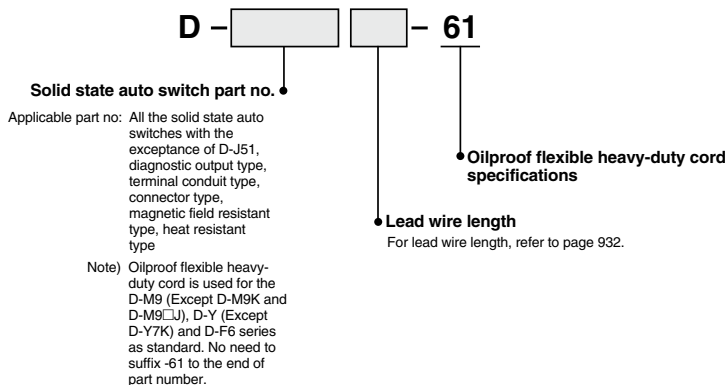

Specifications are the same as standard products with the exception of lead wire specifications.

Lead wire: For D-F8 type..... ø2.7, 0.15 mm², 3 cores (Brown, Blue, Black), 2 cores (Brown, Blue)
For other model nos..... ø3.4, 0.15 mm², 3 cores (Brown, Blue, Black), 2 cores (Brown, Blue)

Dimensions are identical with D-F5 type, G5 type, J59 type, K59 type. Lead wire diameter is changed from ø4 to ø3.4. In other series products, it is common as standard product's specifications.

Reed Auto Switch Direct Mounting Type D-A90(V)/D-A93(V)/D-A96(V)



RoHS

Refer to SMC website for the details of the products conforming to the international standards.

Auto Switch Specifications

PLC: Programmable Logic Controller

Grommet

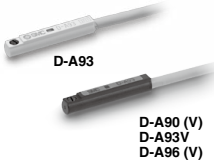

Caution

Precautions

- Do not drop or bump the auto switch while handling it as it may result in the auto switch breaking.
- Do not remove the protective cover attached to the product body until the product is ready to be mounted on the actuator.
- Fix the auto switch with the existing screw installed on the auto switch body. The auto switch may be damaged if a screw other than the one supplied is used.

D-A90, D-A90V (Without indicator light)			
Auto switch model	D-A90, D-A90V		
Applicable load	IC circuit, Relay, PLC		
Load voltage	24 V $\frac{DC}{AC}$ or less	48 V $\frac{DC}{AC}$ or less	100 V $\frac{DC}{AC}$ or less
Maximum load current	50 mA	40 mA	20 mA
Internal circuit*	④		
Contact protection circuit	None		
Internal resistance	1 Ω or less (Including lead wire length of 3 m)		
Standard	CE/UKCA marking		
D-A93, D-A93V, D-A96, D-A96V (With indicator light)			
Auto switch model	D-A93, D-A93V	D-A96, D-A96V	
Applicable load	Relay, PLC	IC circuit	
Load voltage	24 VDC ⁽⁴⁾	100 VAC	4 to 8 VDC
Load current range and Maximum load current ⁽³⁾	5 to 40 mA	5 to 20 mA	20 mA
Internal circuit*	③		⑤
Contact protection circuit	None		
Internal voltage drop	D-A93: 2.4 V or less (up to 20 mA)/3 V or less (up to 40 mA) D-A93V: 2.7 V or less		0.8 V or less
Indicator light	Red LED illuminates when turned ON.		
Standard	CE/UKCA marking		

Oilproof Heavy-duty Lead Wire Specifications

Auto switch model	D-A90(V)	D-A93(V)	D-A96(V)
Sheath	Outside diameter [mm] $\phi 2.7$		
Insulator	Number of cores 2 cores (Brown/Blue)		3 cores (Brown/Blue/Black)
	Outside diameter [mm] $\phi 0.96$		$\phi 0.91$
Conductor	Effective area [mm ²] 0.18		0.15
	Strand diameter [mm] $\phi 0.08$		
Lead wire minimum bending radius [mm] (Reference values)			17

* Refer to the applicable internal circuit diagram (numbers ① to ⑦) on page 935.

Note 1) Refer to page 932 for reed auto switch common specifications.

Note 2) Refer to page 932 for lead wire lengths.

Note 3) Under 5 mA, the strength of the indicator light is poor. In some cases, visibility of the indicator light will not be possible where the output signal is less than 2.5 mA. However, there is no problem in terms of contact output, when an output signal exceeds 1 mA or more.

Note 4) The auto switches can operate at 12 VDC, but consider the internal voltage drop of the auto switch described in Reed Auto Switch Precautions on page 22.

Weight

(g)

Model		D-A90	D-A90V	D-A93	D-A93V	D-A96	D-A96V
Lead wire length	0.5 m (NII)	6	6	6	6	8	8
	1 m (M)	—	—	11	—	—	—
	3 m (L)	30	30	30	30	41	41
	5 m (Z)	—	—	47	47	—	—

Dimensions

(mm)

D-A90/D-A93/D-A96

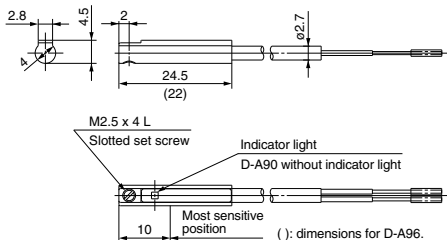

D-A90V/D-A93V/D-A96V

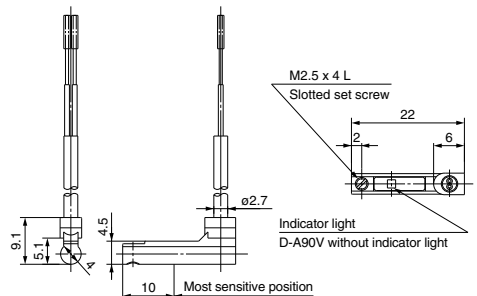

Reed Auto Switch Direct Mounting Type D-90/D-97



Refer to SMC website for the details of the products conforming to the international standards.

**Grommet
Lead wire: Parallel cord**



Auto Switch Specifications

PLC: Programmable Logic Controller

D-90 (Without indicator light)			
Auto switch model	D-90		
Applicable load	Relay, IC circuit, PLC		
Load voltage	5 VAC 5 VDC	12 VAC 12 VDC	24 VAC 24 VDC
Max. load current	50 mA		
Circuit diagram*	④		
Internal resistance	1 Ω or less (Including lead wire length of 3 m)		
Standard	CE/UKCA marking		
D-97 (With indicator light)			
Auto switch model	D-97		
Applicable load	Relay, PLC		
Load voltage	24 VDC ⁽⁴⁾		
Load current range ⁽³⁾	5 to 40 mA		
Circuit diagram*	③		
Internal voltage drop	2.4 V or less		
Indicator light	Red LED illuminates when turned ON.		
Standard	CE/UKCA marking		

Vinyl Parallel Cord Specifications

Auto switch model		D-90	D-97
Insulator	Number of cores	2 cores	
	Outside diameter [mm]	ø1.4	
Conductor	Effective area [mm ²]	0.2	
	Strand diameter [mm]	ø0.08	
Lead wire minimum bending radius [mm] (Reference values)		9	

* Refer to the circuit diagram no. on page 935.

Note 1) Refer to page 932 for reed auto switch common specifications.

Note 2) Refer to page 932 for lead wire lengths.

Note 3) Under 5 mA, the strength of the indicator light is poor. In some cases, visibility of the indicator light will not be possible where the output signal is less than 2.5 mA. However, there is no problem in terms of contact output, when an output signal exceeds 1 mA or more.

Note 4) The auto switches can operate at 12 VDC, but consider the internal voltage drop of the auto switch described in Reed Auto Switch Precautions on page 22.

Weight

(g)

Auto switch model	D-90	D-97
0.5 m (NI)	5	5
3 m (L)	23	23
5 m (Z)	37	37

Dimensions

(mm)

D-90

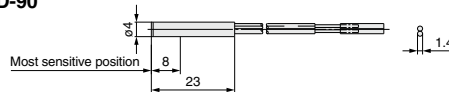

D-97

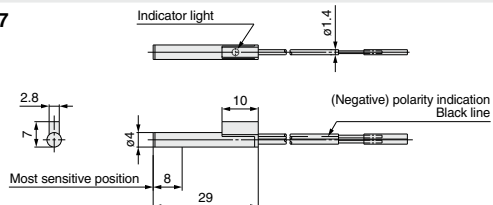

Reed Auto Switch Direct Mounting Type D-90A/D-93A



Refer to SMC website for the details of the products conforming to the international standards.

**Grommet
Lead wire: Heavy-duty cord**



Auto Switch Specifications

PLC: Programmable Logic Controller

D-90A (Without indicator light)				
Auto switch model	D-90A			
Applicable load	Relay, IC circuit, PLC			
Load voltage	5 VAC 5 VDC	12 VAC 12 VDC	24 VAC 24 VDC	100 VAC 100 VDC
Max. load current	50 mA			20 mA
Circuit diagram*	④			
Internal resistance	1 Ω or less (Including lead wire length of 3 m)			
Standard	CE/UKCA marking			
D-93A (With indicator light)				
Auto switch model	D-93A			
Applicable load	Relay, PLC			
Load voltage	24 VDC (4)		100 VAC	
Load current range (3)	5 to 40 mA		5 to 20 mA	
Circuit diagram*	③			
Internal voltage drop	2.4 V or less			
Indicator light	Red LED illuminates when turned ON.			
Standard	CE/UKCA marking			

Oilproof Heavy-duty Lead Wire Specifications

Auto switch model		D-90A-D-93A
Sheath	Outside diameter [mm]	ø3.4
	Number of cores	2 cores (Brown/Blue)
Insulator	Outside diameter [mm]	ø1.1
	Effective area [mm ²]	0.2
Conductor	Strand diameter [mm]	ø0.08
	Lead wire minimum bending radius [mm] (Reference values)	21

* Refer to the circuit diagram no. on page 935.

Note 1) Refer to page 932 for reed auto switch common specifications.

Note 2) Refer to page 932 for lead wire lengths.

Note 3) Under 5 mA, the strength of the indicator light is poor. In some cases, visibility of the indicator light will not be possible where the output signal is less than 2.5 mA. However, there is no problem in terms of contact output, when an output signal exceeds 1 mA or more.

Note 4) The auto switches can operate at 12 VDC, but consider the internal voltage drop of the auto switch described in Reed Auto Switch Precautions on page 22.

Weight

(g)

Auto switch model		D-90A	D-93A
Lead wire length	0.5 m (NI)	9	9
	3 m (L)	47	47
	5 m (Z)	77	77

Dimensions

(mm)

D-90A

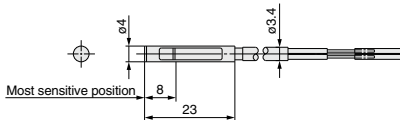

D-93A

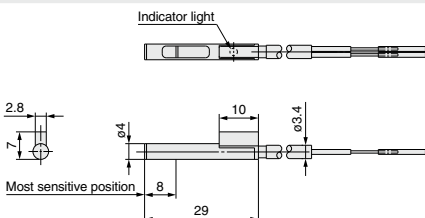

Reed Auto Switch Direct Mounting Type D-R73/D-R80



Refer to SMC website for the details of the products conforming to the international standards.

**Grommet
Electrical entry: In-line**



Auto Switch Specifications

PLC: Programmable Logic Controller

D-R73□ (With indicator light)			
Auto switch model	D-R731, D-R732		
Applicable load	Relay, PLC		
Load voltage	24 VDC ⁽⁴⁾	100 VAC	
Load current range ⁽³⁾	5 to 40 mA	5 to 20 mA	
Circuit diagram*	③		
Internal voltage drop	2.4 V or less		
Indicator light	Red LED illuminates when turned ON.		
Standard	CE/UKCA marking		
D-R80□ (Without indicator light)			
Auto switch model	D-R801, D-R802		
Applicable load	Relay, IC circuit, PLC		
Load voltage	24 V ^{AC} _{DC} or less	48 V ^{AC} _{DC}	100 V ^{AC} _{DC}
Max. load current	50 mA	40 mA	20 mA
Circuit diagram*	④		
Internal resistance	1 Ω or less (Including lead wire length of 3 m)		
Standard	CE/UKCA marking		

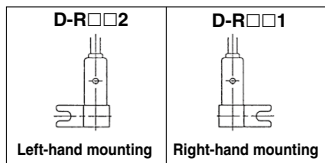

Oilproof Heavy-duty Lead Wire Specifications

Auto switch model		D-R73□-D-R80□	
Sheath	Outside diameter [mm]	ø3.4	
Insulator	Number of cores	2 cores (Brown/Blue)	
	Outside diameter [mm]	ø1.1	
Conductor	Effective area [mm ²]	0.2	
	Strand diameter [mm]	ø0.08	
Lead wire minimum bending radius [mm] (Reference values)		21	

* Refer to the circuit diagram no. on page 935.

Note 1) Refer to page 932 for reed auto switch common specifications.

Note 2) Refer to page 932 for lead wire lengths.

Note 3) Under 5 mA, the strength of the indicator light is poor. In some cases, visibility of the indicator light will not be possible where the output signal is less than 2.5 mA. However, there is no problem in terms of contact output, when an output signal exceeds 1 mA or more.

Note 4) The auto switches can operate at 12 VDC, but consider the internal voltage drop of the auto switch described in Reed Auto Switch Precautions on page 22.

Weight

(g)

Auto switch model	D-R73□	D-R80□
Lead wire length		
0.5 m (Nil)	11	11
3 m (L)	49	49
5 m (Z)	79	79

Dimensions

(mm)

D-R731: Right-hand mounting

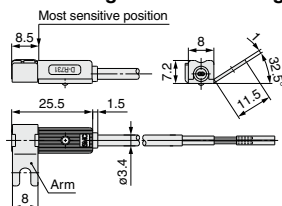

D-R732: Left-hand mounting

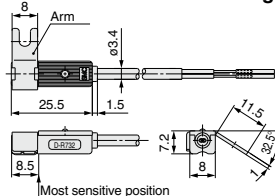

D-R801: Right-hand mounting

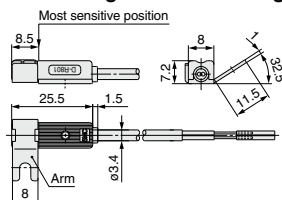

D-R802: Left-hand mounting

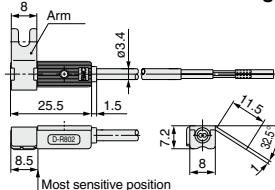

Reed Auto Switch Direct Mounting Type

D-R73□C/D-R80□C



Refer to SMC website for the details of the products conforming to the international standards.

**Connector
Electrical entry: In-line**



Caution

Precautions

1. Confirm that there is no looseness after wiring. The looseness will decrease water resistance.
2. Refer to the **Web Catalog** for the details.

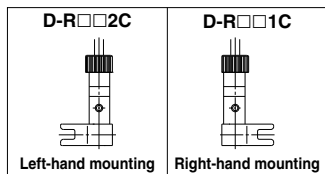

Auto Switch Specifications

PLC: Programmable Logic Controller

D-R73□C (With indicator light)	
Auto switch model	D-R731C, D-R732C
Applicable load	Relay, PLC
Load voltage	24 VDC ⁽⁵⁾
Load current range ⁽⁴⁾	5 to 40 mA
Circuit diagram *	③
Internal voltage drop	2.4 V or less
Indicator light	Red LED illuminates when turned ON.
Standard	CE/UKCA marking
D-R80□C (Without indicator light)	
Auto switch model	D-R801C, D-R802C
Applicable load	Relay, IC circuit, PLC
Load voltage	24 V _{DC} ^{AC}
Max. load current	50 mA
Circuit diagram *	④
Internal resistance	1 Ω or less (Including lead wire length of 3 m)
Standard	CE/UKCA marking

* Refer to the circuit diagram no. on page 935.

Note 1) Refer to page 932 for reed auto switch common specifications.

Note 2) Refer to page 932 for lead wire lengths.

Note 3) Lead wire with connector may be shipped with the auto switch.

Note 4) Under 5 mA, the strength of the indicator light is poor. In some cases, visibility of the indicator light will not be possible where the output signal is less than 2.5 mA. However, there is no problem in terms of contact output, when an output signal exceeds 1 mA or more.

Note 5) The auto switches can operate at 12 VDC, but consider the internal voltage drop of the auto switch described in Reed Auto Switch Precautions on page 22.

Weight

(g)

Auto switch model	D-R73□C	D-R80□C
Lead wire length (m)	0.5	12
	3	51
	5	81

Dimensions

(mm)

D-R731C: Right-hand mounting

D-R732C: Left-hand mounting

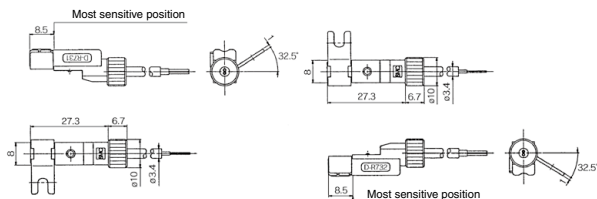

D-R801C: Right-hand mounting

D-R802C: Left-hand mounting

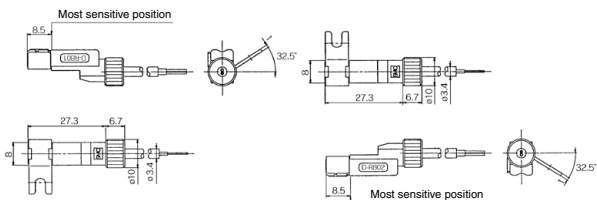

Lead wires with a connector indication

Part No. of Lead Wires with Connectors

(Applicable only for connector type)

Model	Lead wire length
D-LC05	0.5 m
D-LC30	3 m
D-LC50	5 m

Reed Auto Switch Rail Mounting Type D-A72/D-A73/D-A80



Refer to SMC website for the details of the products conforming to the international standards.

Grommet
Electrical entry: Perpendicular



Caution

Precautions

Do not drop or bump the auto switch while handling it as it may result in the auto switch breaking.

Auto Switch Specifications

PLC: Programmable Logic Controller

D-A7 (With indicator light)			
Auto switch model	D-A72	D-A73	
Applicable load	Relay, PLC	Relay, PLC	
Load voltage	200 VAC	24 VDC ⁽⁴⁾	100 VAC
Load current range ⁽³⁾	5 to 10 mA	5 to 40 mA	5 to 20 mA
Internal circuit [*]	③		
Contact protection circuit	None		
Internal voltage drop	2.4 V or less		
Indicator light	Red LED illuminates when turned ON.		
Standard	CE/UKCA marking		
D-A8 (Without indicator light)			
Auto switch model	D-A80		
Applicable load	Relay, IC circuit, PLC		
Load voltage	24 V ^{AC} or less	48 V ^{DC}	100 V ^{AC}
Maximum load current	50 mA	40 mA	20 mA
Internal circuit [*]	④		
Contact protection circuit	None		
Internal resistance	1 Ω or less (including lead wire length of 3 m)		
Standard	CE/UKCA marking		

Oilproof Heavy-duty Lead Wire Specifications

Auto switch model		D-A72	D-A73	D-A80
Sheath	Outside diameter [mm]	ø3.4		
	Number of cores	2 cores (Brown/Blue)		
Insulator	Outside diameter [mm]	ø1.1		
	Effective area [mm ²]	0.2		
Conductor	Strand diameter [mm]	ø0.08		
	Lead wire minimum bending radius [mm] (Reference values)	21		

* Lead wire Oilproof vinyl cabtire cord: ø3.4, 0.2 mm², 2 cores (Brown, Blue), 0.5 m
* Refer to the applicable internal circuit diagram (numbers ① to ⑦) on page 935.

Note 1) Refer to page 932 for reed auto switch common specifications.

Note 2) Refer to page 932 for lead wire lengths.

Note 3) Under 5 mA, the strength of the indicator light is poor. In some cases, visibility of the indicator light will not be possible where the output signal is less than 2.5 mA. However, there is no problem in terms of contact output, when an output signal exceeds 1 mA or more.

Note 4) The auto switches can operate at 12 VDC, but consider the internal voltage drop of the auto switch described in Reed Auto Switch Precautions on page 22.

Weight

(g)

Auto switch model		D-A72	D-A73	D-A80
Lead wire length	0.5 m (NII)	10	10	10
	3 m (L)	47	47	47
	5 m (Z)	—	77	—

Dimensions

(mm)

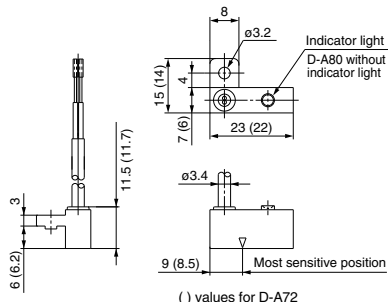

() values for D-A72

Reed Auto Switch Rail Mounting Type D-A7□H/D-A80H



Refer to SMC website for the details of the products conforming to the international standards.

**Grommet
Electrical entry: In-line**



⚠ Caution

Precautions

Do not drop or bump the auto switch while handling it as it may result in the auto switch breaking.

Auto Switch Specifications

PLC: Programmable Logic Controller

D-A7□H (With indicator light)			
Auto switch model	D-A72H	D-A73H	D-A76H
Applicable load	Relay, PLC	Relay, PLC	IC circuit
Load voltage	200 VAC	24 VDC ⁽⁴⁾ 100 VAC	4 to 8 VDC
Max. load current/Load current range ⁽³⁾	5 to 10 mA	5 to 40 mA 5 to 20 mA	20 mA
Internal circuit*	③		⑤
Contact protection circuit	None		
Internal voltage drop	2.4 V or less		0.8 V or less
Indicator light	Red LED illuminates when turned ON.		
Standard	CE/UKCA marking		
D-A80H (Without indicator light)			
Auto switch model	D-A80H		
Applicable load	Relay, IC circuit, PLC		
Load voltage	24 V ^{AC} _{DC} or less	48 V ^{AC} _{DC}	100 V ^{AC} _{DC}
Maximum load current	50 mA	40 mA	20mA
Internal circuit*	④		
Contact protection circuit	None		
Internal resistance	1 Ω or less (Including lead wire length of 3 m)		
Standard	CE/UKCA marking		

Oilproof Heavy-duty Lead Wire Specifications

Auto switch model		D-A72H/A73H	D-A76H	D-A80H
Sheath	Outside diameter [mm]	ø3.4		
Insulator	Number of cores	2 cores (Brown/Blue)	3 cores (Brown/Blue/Black)	2 cores (Brown/Blue)
	Outside diameter [mm]	ø1.1		
Conductor	Effective area [mm ²]	0.2		
	Strand diameter [mm]	ø0.08		
Lead wire minimum bending radius [mm] (Reference values)		21		

* Refer to the applicable internal circuit diagram (numbers ① to ⑦) on page 935.

Note 1) Refer to page 932 for reed auto switch common specifications.

Note 2) Refer to page 932 for lead wire lengths.

Note 3) Under 5 mA, the strength of the indicator light is poor. In some cases, visibility of the indicator light will not be possible where the output signal is less than 2.5 mA. However, there is no problem in terms of contact output, when an output signal exceeds 1 mA or more.

Note 4) The auto switches can operate at 12 VDC, but consider the internal voltage drop of the auto switch described in Reed Auto Switch Precautions on page 22.

Weight

(g)

Auto switch model		D-A72H	D-A73H	D-A76H	D-A80H
Lead wire length	0.5 m (NII)	10	10	11	10
	3 m (L)	47	47	52	47
	5 m (Z)	—	77	—	—

Dimensions

(mm)

D-A7□H, D-A80H

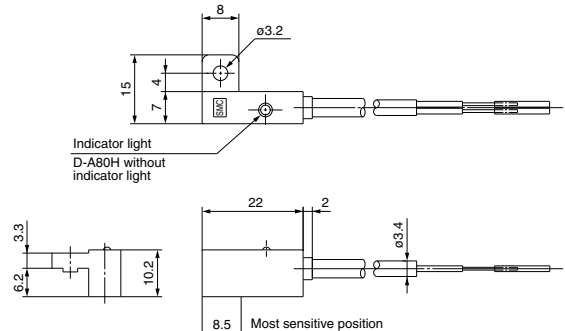

Reed Auto Switch Rail Mounting Type D-A73C/D-A80C



Refer to SMC website for the details of the products conforming to the international standards.

Auto Switch Specifications

PLC: Programmable Logic Controller

Connector



Caution

Precautions

1. Do not drop or bump the auto switch while handling it as it may result in the auto switch breaking.
2. Confirm that the connector is appropriately tightened. If tightened insufficiently, the waterproof performance will deteriorate.
3. Refer to the **Web Catalog** for the details.

D-A73C (With indicator light)	
Auto switch model	D-A73C
Applicable load	Relay, PLC
Load voltage	24 VDC ⁽⁵⁾
Load current range ⁽⁴⁾	5 to 40 mA
Internal circuit*	③
Contact protection circuit	None
Internal voltage drop	2.4 V or less
Indicator light	Red LED illuminates when turned ON.
Standard	CE/UKCA marking
D-A80C (Without indicator light)	
Auto switch model	D-A80C
Applicable load	Relay, IC circuit, PLC
Load voltage	24 V ^{AC} _{DC}
Maximum load current	50 mA
Internal circuit*	④
Contact protection circuit	None
Internal resistance	1 Ω or less (Including lead wire length of 3 m)
Standard	CE/UKCA marking

* Refer to the applicable internal circuit diagram (numbers ① to ⑦) on page 935.

Note 1) Refer to page 932 for reed auto switch common specifications.

Note 2) Refer to page 932 for lead wire lengths.

Note 3) Lead wire with connector may be shipped with the auto switch.

Note 4) Under 5 mA, the strength of the indicator light is poor. In some cases, visibility of the indicator light will not be possible where the output signal is less than 2.5 mA. However, there is no problem in terms of contact output, when an output signal exceeds 1 mA or more.

Note 5) The auto switches can operate at 12 VDC, but consider the internal voltage drop of the auto switch described in Reed Auto Switch Precautions on page 22.

Weight

(g)

Auto switch model		D-A73C	D-A80C
Lead wire length	0.5 m (Nil)	12	12
	3 m (L)	54	54
	5 m (Z)	84	84

Lead wires with a connector indication

Part No. of Lead Wires with Connectors
(Applicable only for connector type)

Model	Lead wire length
D-LC05	0.5 m
D-LC30	3 m
D-LC50	5 m

Dimensions

(mm)

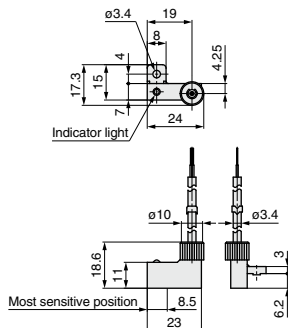

Reed Auto Switch Tie-rod Mounting Type D-A5□/□/□/□/□/□/□/□



Refer to SMC website for the details of the products conforming to the international standards.

Grommet



Caution

Precautions

Do not drop or bump the auto switch while handling it as it may result in the auto switch breaking.

Auto Switch Specifications

PLC: Programmable Logic Controller

D-A5 (With indicator light)					
Auto switch model	D-A53	D-A54		D-A56	
Applicable load	PLC	Relay, PLC		IC circuit	
Load voltage	24 VDC (4)	24 VDC (4)	100 VAC	200 VAC	4 to 8 VDC
Maximum load (3) current and range	5 to 50 mA	5 to 50 mA	5 to 25 mA	5 to 12.5 mA	20 mA
Internal circuit*	(3)	(1)		(5)	
Contact protection circuit	None	Built-in		None	
Internal voltage drop	2.4 V or less	2.4 V or less (Up to 20 mA)/3.5 V or less (Up to 50 mA)		0.8 V or less	
Indicator light	Red LED illuminates when turned ON.				
Standard	CE/UKCA marking				
D-A6 (Without indicator light)					
Auto switch model	D-A64			D-A67	
Applicable load	Relay, PLC			PLC/IC circuit	
Load voltage	24 V ^{AC} _{DC} or less	100 VAC	200 VAC	Max. 24 VDC	
Maximum load current	50 mA	25 mA	12.5 mA	30 mA	
Internal circuit*	(2)			(4)	
Contact protection circuit	Built-in			None	
Internal resistance	25 Ω or less			1 Ω or less (Including lead wire length of 3 m)	
Standard	CE/UKCA marking				

Oilproof Heavy-duty Lead Wire Specifications

Auto switch model		D-A53/A54	D-A56	D-A64/A67
Sheath	Outside diameter [mm]	ø4		
Insulator	Number of cores	2 cores (Brown/Blue)	3 cores (Brown/Blue/Black)	2 cores (Brown/Blue)
	Outside diameter [mm]	ø1.22		
Conductor	Effective area [mm ²]	0.3	0.2	0.3
	Strand diameter [mm]	ø0.08		
	Lead wire minimum bending radius [mm] (Reference values)	24		

* Refer to the applicable internal circuit diagram (numbers ① to ⑦) on page 935.

Note 1) Refer to page 932 for reed auto switch common specifications.

Note 2) Refer to page 932 for lead wire lengths.

Note 3) Under 5 mA, the strength of the indicator light is poor. In some cases, visibility of the indicator light will not be possible where the output signal is less than 2.5 mA. However, there is no problem in terms of contact output, when an output signal exceeds 1 mA or more.

Note 4) The auto switches can operate at 12 VDC, but consider the internal voltage drop of the auto switch described in Reed Auto Switch Precautions on page 22.

Weight

(g)

Auto switch model		D-A53	D-A54	D-A56	D-A64	D-A67
Lead wire length	0.5 m (NII)	24	—	24	—	24
	3 m (L)	80	—	80	—	80
	5 m (Z)	125	—	—	—	—

Dimensions

(mm)

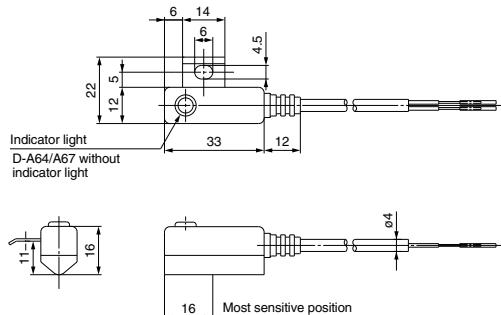

2-Color Indicator Reed Auto Switch Rail Mounting Type D-A79W



Refer to SMC website for the details of the products conforming to the international standards.

Grommet

The proper operating range can be determined by the color of the light.
(Red → Green ← Red)



Caution

Precautions

Do not drop or bump the auto switch while handling it as it may result in the auto switch breaking.

Auto Switch Specifications

PLC: Programmable Logic Controller

D-A79W (With indicator light)	
Auto switch model	D-A79W
Applicable load	Relay, PLC
Load voltage	24 VDC
Load current range ⁽³⁾	5 to 40 mA
Internal circuit*	⑦
Contact protection circuit	None
Internal voltage drop	4 V or less
Indicator light	Operating range Red LED illuminates. Proper operating range Green LED illuminates.
Standard	CE/UKCA marking

Oilproof Heavy-duty Lead Wire Specifications

Auto switch model		D-A79W
Sheath	Outside diameter [mm]	ø3.4
	Number of cores	2 cores (Brown/Blue)
Insulator	Outside diameter [mm]	ø1.1
	Effective area [mm ²]	0.2
Conductor	Strand diameter [mm]	ø0.08
	Lead wire minimum bending radius [mm] (Reference values)	21

* Refer to the applicable internal circuit diagram (numbers ① to ⑦) on page 935.

Note 1) Refer to page 932 for reed auto switch common specifications.

Note 2) Refer to page 932 for lead wire lengths.

Note 3) Under 5 mA, the strength of the indicator light is poor. In some cases, visibility of the indicator light will not be possible where the output signal is less than 2.5 mA. However, there is no problem in terms of contact output, when an output signal exceeds 1 mA or more.

Weight

(g)

Auto switch model		D-A79W
Lead wire length	0.5 m (NII)	11
	3 m (L)	53

Dimensions

(mm)

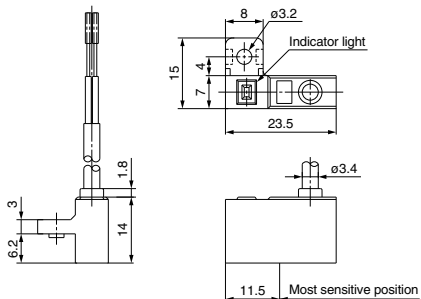

2-Color Indicator Reed Auto Switch Tie-rod Mounting Type D-A59W



Refer to SMC website for the details of the products conforming to the international standards.

Grommet

The proper operating range can be determined by the color of the light.
(Red → Green ← Red)



Caution

Precautions

Do not drop or bump the auto switch while handling it as it may result in the auto switch breaking.

Auto Switch Specifications

PLC: Programmable Logic Controller

D-A59W (With indicator light)	
Auto switch model	D-A59W
Applicable load	Relay, PLC
Load voltage	24 VDC
Load current range ⁽³⁾	5 to 40 mA
Internal circuit*	⑥
Contact protection circuit	Built-in
Internal voltage drop	4 V or less
Indicator light	Operating range Red LED illuminates. Proper operating range Green LED illuminates.
Standard	CE/UKCA marking

Oilproof Heavy-duty Lead Wire Specifications

Auto switch model		D-A59W
Sheath	Outside diameter [mm]	ø4
	Number of cores	2 cores (Brown/Blue)
Insulator	Outside diameter [mm]	ø1.22
	Effective area [mm ²]	0.3
Conductor	Strand diameter [mm]	ø0.08
	Lead wire minimum bending radius [mm] (Reference values)	24

* Refer to the applicable internal circuit diagram (numbers ① to ⑦) on page 935.

Note 1) Refer to page 932 for reed auto switch common specifications.

Note 2) Refer to page 932 for lead wire lengths.

Note 3) Under 5 mA, the strength of the indicator light is poor. In some cases, visibility of the indicator light will not be possible where the output signal is less than 2.5 mA. However, there is no problem in terms of contact output, when an output signal exceeds 1 mA or more.

Weight

(g)

Auto switch model		D-A59W
Lead wire length	0.5 m (NII)	25
	3 m (L)	80

Dimensions

(mm)

