

Ionizer

Series IZS31

● 3 types of the sensors are available.

- Autobalance sensor [High-precision type]
Adjusts offset voltage near the workpiece to reduce any disturbance interference!

- Autobalance sensor [Body-mounting type]



- Rapid neutralization of static electricity by a feedback sensor: **0.3 seconds**

Conditions / Discharge time from 1000 V to 100 V
Discharged object: Charged plate
(150 mm x 150 mm, capacitance 20 pF)

Installation distance: 200 mm (Tungsten emitter with air purge)

- Continuously emits ions in accordance with the polarity applied onto a workpiece.

Supply pressure: 0.1 MPa (7 L/min (ANR) per nozzle)

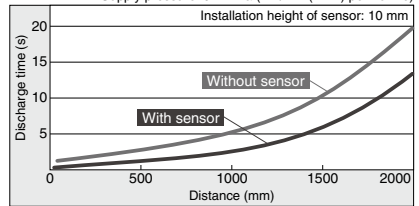

<Conditions> Static neutralization features are based on the data using the charged plate (size: 150 mm x 150 mm, capacitance: 20 pF) as defined in the U.S. ANSI standards (ANSI/ESD: STM3. 1-2015). Use this as a guideline purpose only for model selection because the value varies depending on the material and/or size of a subject.



Controlled offset voltage by sensor

Pressure Sensor

Pressure Control

Flow Sensor

Position Detection Switch

Reduced-wiring Fieldbus System

Static Neutralization Equipment

Length Measuring/Counter

Alphabetical Index

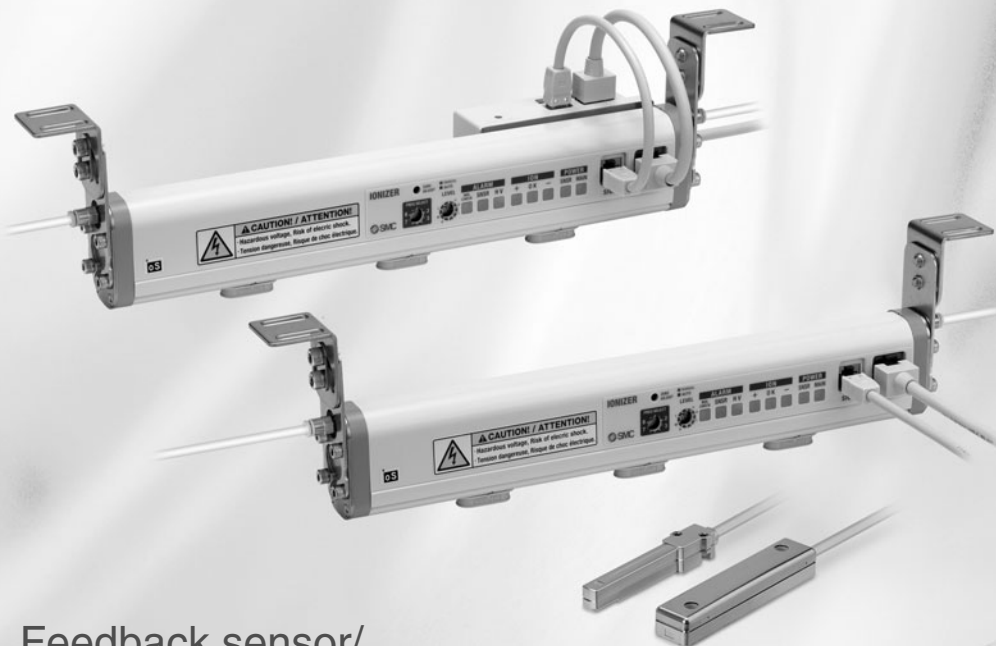

Feedback sensor/ Rapid neutralization of static electricity

Feedback sensor

Detects the polarity of a discharged object and measures the charged voltage.

■ Rapid neutralization of static electricity by a feedback sensor

- The discharge speed has been increased by reading the workpiece's electrostatic potential by the feedback sensor and continuously emitting ions with a reverse polarity.

Supply pressure: 0.1 MPa (7 L/min (ANR) per nozzle)

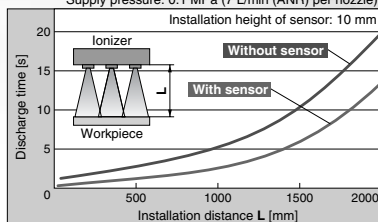
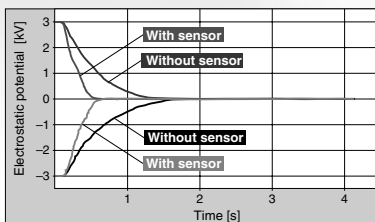

- Run mode after static neutralization (electrostatic potential: within ± 30 V) can be selected.

Energy saving run mode: Stops generating ions after static neutralization to reduce power consumption. Air consumption can also be reduced by controlling the pneumatic valve with a static neutralization completion signal.

Note) The pneumatic valve must be separately procured.

Continuous static neutralization run mode: After static neutralization, the ionizer switches to pulse DC mode and continues to neutralize static electricity to make it approach 0 V even if the electrostatic potential is within ± 30 V.

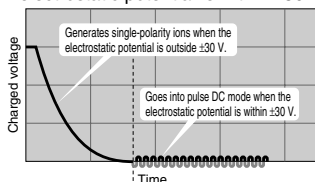

Mode	Ion emission waveform
Sensing DC	+
Energy saving run	Stop
Sensing DC	+
Continuous static neutralization run	Pulse DC
Pulse DC	+
	-
+ charged image	Static neutralization completion

Autobalance sensor/ Reduction of adjustment and maintenance labor

Autobalance sensor

Measures the nearest offset voltage.



Autobalance sensor [High-precision type]

- The offset voltage near the workpiece is accurately adjusted.
- Reduces the variation in the offset voltage of the static neutralization area due to the effect from the installation height and disturbance.

The mode can be selected from “Manual Run” mode which performs adjustment only when connected, and “Automatic Run” mode which always performs adjustment while connected.

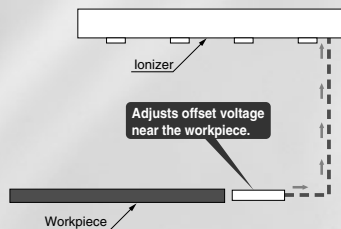

Autobalance sensor [Body-mounting type] can be mounted on the body, and can be installed in any places.

The offset voltage in the initial state is controlled so that the voltage is maintained at a constant value by monitoring the ion emitted from the ionizer using the ground line, and adjusting the + and - ion supply rate.



Autobalance sensor [Body-mounting type]

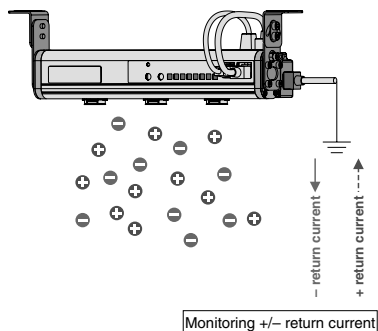

Offset voltage of static neutralization area

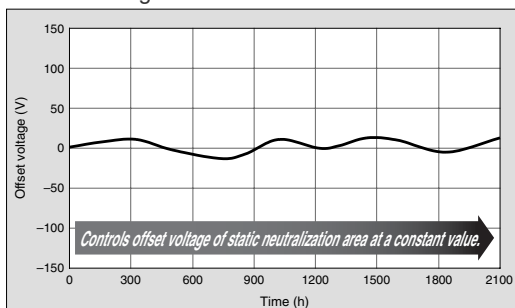

Pressure Sensor

Pressure Control

Flow Sensor

Position Detection Switch

Reduced-wiring Fieldbus System

Static Neutralization Equipment

Length Measuring/Counter

Alphabetical Index

Emitter cartridge variations

High speed static neutralization cartridge, focusing on discharge time and energy saving

[High speed static neutralization cartridge]

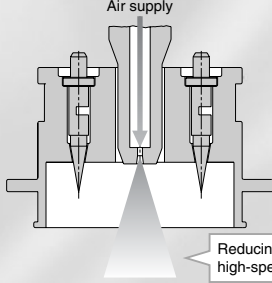

- High-efficiency nozzle design improves discharge speed with low air consumption.



Low maintenance cartridge, focusing on offset voltage and reducing maintenance labor

[Low maintenance cartridge]

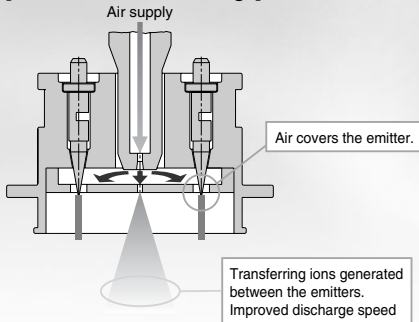

- Stain on emitter is reduced by compressed air.



Low maintenance cartridge

Reduces stain on emitter.



Conventional model

Needs regular maintenance.

3 types of emitter materials

- Tungsten: Offset voltage within ± 30 V
- Single crystal silicon: Offset voltage within ± 30 V, suitable for neutralizing static electricity of silicon wafer
- Stainless steel*: Offset voltage within ± 100 V, low-cost type, suitable for environments sensitive to heavy metal contamination such as food processing

* Only for high speed static neutralization cartridge

Applicable to workpiece moving at high speed

- Switching over frequency: Max. **60 Hz**
Ions are discharged at high density at workpieces moving at high speed.

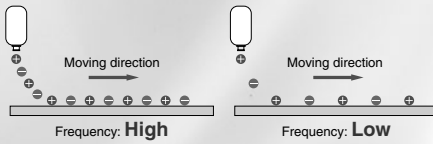

This reduces the range of surface potential fluctuations for short installation distances after static neutralization.

(Note) The range of surface potential fluctuations varies depending on the object's material, etc.

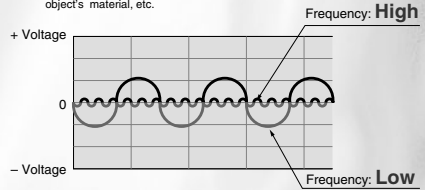

Effective static neutralization for short distance

- Prevention of irregular static neutralization
Emitter cartridge 40 mm-pitch: **-X15**
(Standard: 80 mm-pitch)
(Length: 1260 mm or less)
(Note) 80 mm-pitch in case of air purge

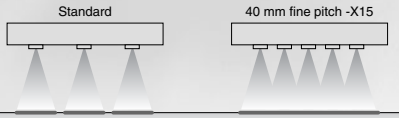
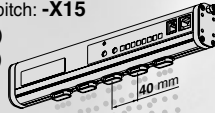

Applicable to purge pressure of 0.7 MPa

Air purge: Yes, With sensor: 1 Hz/60 Hz

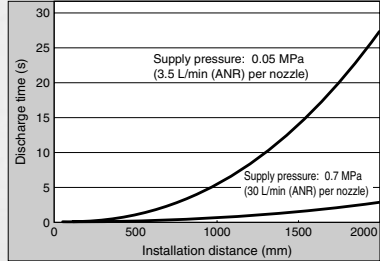

Indicator functions

- Visualization of charging condition
(During sensing DC mode)

Workpiece electric polarity	LED + OK	Workpiece electric charge voltage	Light ON
Positive	■	+400 V or higher	■
Static neutralization completion	■	+100 V to +400 V	■
	■	+30 V to +100 V	■
Negative	■	Within ±30 V	■
	■	-30 V to -100 V	■
	■	-100 V to -400 V	■
	■	-400 V or lower	■

Flash at 4 Hz
Light OFF

- Visualization of offset voltage
(When pulse DC mode or autobalance sensor are used.)



Contamination of emitter can be checked at the same time.

Light ON: Within ±30 V
Flash: Around ±30 V
Light OFF and Alarm output: Adjustment is not possible.

Continuous ion emission of a desired polarity during DC mode

- Can be used to remove static electricity from fast-charged or high-potential workpieces or to electrostatically charge them.

Detects the electric potential difference and outputs in an analog voltage.

(During sensing DC mode)

- Outputs measured data at a 1 to 5 V level when a feedback sensor is used. By outputting the data to a PLC, etc., it is possible to control static electricity.

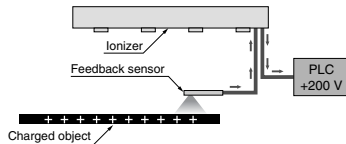

Safety functions

- Emitter cartridge drop prevention
Locking by double-action

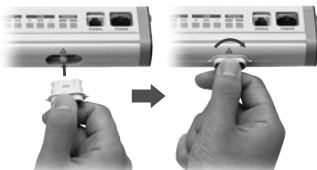

- Security cover
Can even more reliably prevent emitter cartridges from dropping off.



Made to Order

Ionizer/Series IZS31

Symbol	Contents	Specifications
X10	Non-standard bar length Model with 80 mm-pitch emitter cartridges	460, 540, 700, 860, 940, 1020, 1180, 1340, 1420, 1580, 1660, 1740, 1820, 1980, 2060, 2140, 2220
X14	Model with security cover	The main unit is shipped fitted with a security cover available as an option.
X15	Model with 40 mm-pitch emitter cartridges	This model comes fitted with emitter cartridges arranged at a 40 mm-pitch. (Standard pitch: 80 mm) Note) Maximum bar length is 1260 mm. The air purge nozzles are arranged at an 80 mm-pitch.
X210	High-voltage/control unit detachable short type Model with 80 mm-pitch emitter cartridges	A short type ionizer (full length of 180 mm and 220 mm) can be installed in a small space. The high-voltage unit (ionizing unit) and control unit are detachable from each other.
X211	High-voltage/control unit detachable short type Model with 40 mm-pitch emitter cartridges	The distance between them is also optional according to the length of selected connection cables.

Power supply cable

X13	Non-standard power supply cable length	Power supply cable full length: 1 m to 20 m
-----	--	---

AC adapter

X196	Ionizer driving AC adapter	Input voltage: 100 V to 240 V, Output voltage: 24 VDC
------	----------------------------	---

Variations

Bracket

End bracket

End bracket



Center bracket

Center bracket

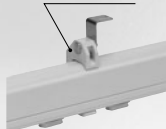

Bar length (mm)

300, 380, 620, 780, 1100, 1260, 1500, 1900, 2300

Power supply cable

3 m, 10 m

Sensor

Feedback sensor



Autobalance sensor [High-precision type]

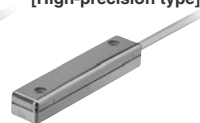

Autobalance sensor [Body-mounting type]



Autobalance sensor [Body-mounting type]

Emitter cartridge

High speed static neutralization cartridge



Emitter material
 • Tungsten
 • Silicon
 • Stainless steel

Low maintenance cartridge



Emitter material
 • Tungsten
 • Silicon

Application Examples

Neutralizing static electricity on PET bottles

- Trip-resistance during conveying
- Prevents adhesion of dust.

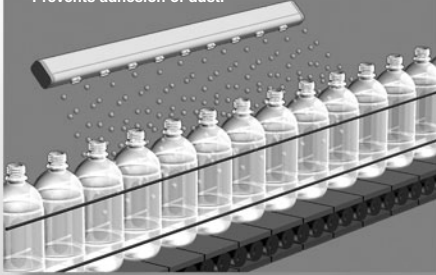

Neutralizing static electricity on a film

- Prevents adhesion of dust.
- Prevents winding failure due to wrinkles, etc.

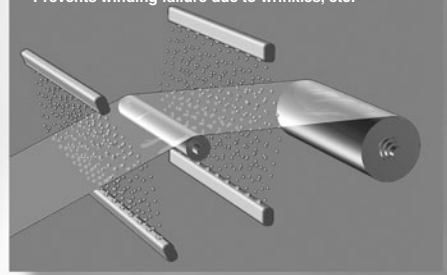

Neutralizing static electricity on molded goods

- Improves detachability of molded goods from a die.

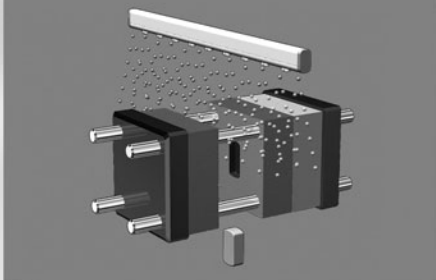

Neutralizing static electricity on film molded goods

- Prevents attaching to conveyor.
- Prevents dispersion of finished goods.

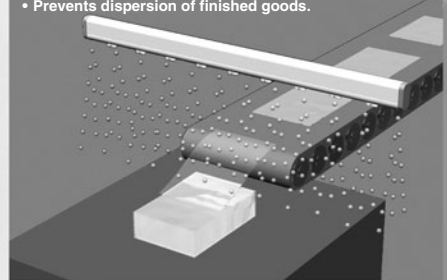

Neutralizing static electricity during wafer transfer

- Prevents breakage due to discharge between wafers and hands.

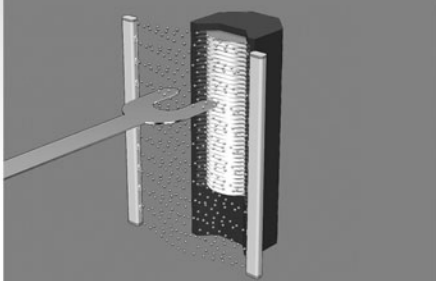

Neutralizing static electricity from packing films

- Prevents the filled substance from adhering to the packing film.
- Reduces packing mistakes.

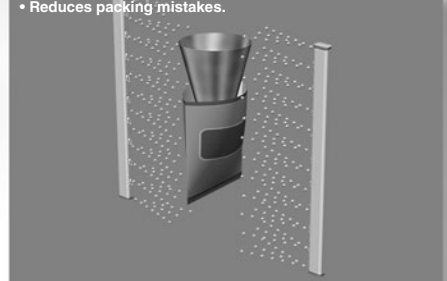

Neutralizing static electricity on an electric substrate

- Prevents element disruption due to discharge.
- Prevents adhesion of dust.

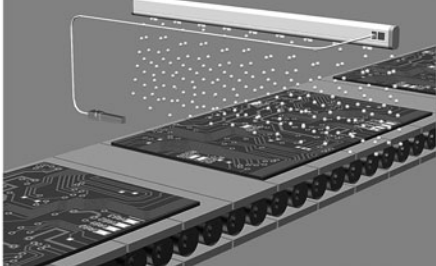

Neutralizing static electricity on a glass substrate

- Prevents breakage due to adhesion and discharge.
- Prevents adhesion of dust.

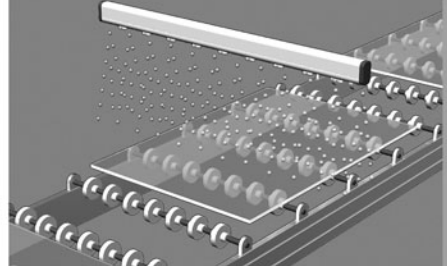

Pressure Sensor

Pressure Control

Flow Sensor

Position Detection Switch

Reduced-wiring Fieldbus System

Static Neutralization Equipment

Length Measuring/Counter

Alphabetical Index

Technical Data 1

Note) Static neutralization features are based on the data using the charged plate (size: 150 mm x 150 mm, capacitance: 20 pF) as defined in the U.S. ANSI standards (ANSI/ESD, STM3. 1-2015). For "Sensing DC" mode, the installation height of the sensor is 10 mm. Use this as a guideline purpose only for model selection because the value varies depending on the material and/or size of a subject.

Static Neutralization Characteristics

1) Installation distance and discharge time (Discharge time from 1000 V to 100 V)

High speed static neutralization cartridge

Air purge: No

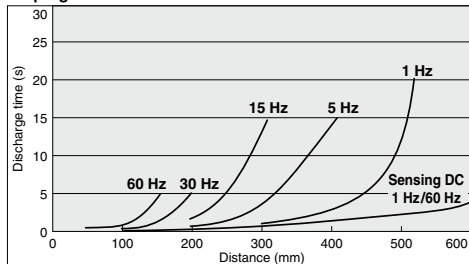

Air purge: Yes Supply pressure: 0.02 MPa (1 L/min (ANR) per nozzle)

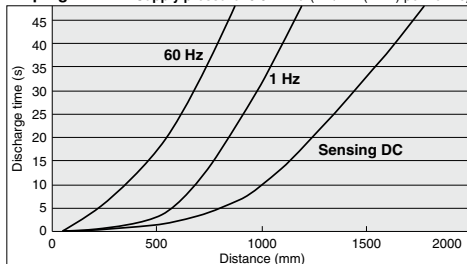

Air purge: Yes Supply pressure: 0.05 MPa (3.5 L/min (ANR) per nozzle)

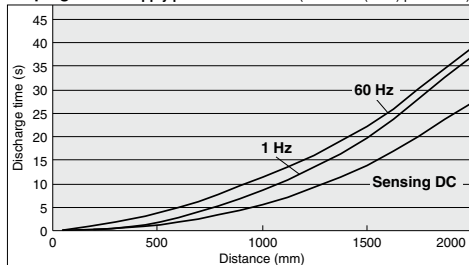

Air purge: Yes Supply pressure: 0.1 MPa (7 L/min (ANR) per nozzle)

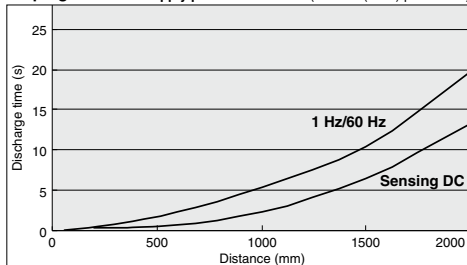

Air purge: Yes Supply pressure: 0.3 MPa (14 L/min (ANR) per nozzle)

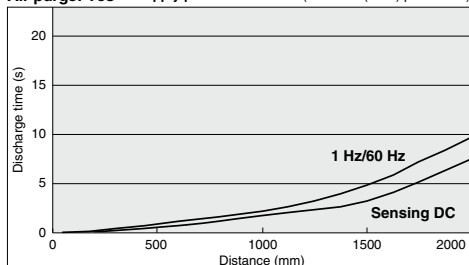

Air purge: Yes Supply pressure: 0.5 MPa (20 L/min (ANR) per nozzle)

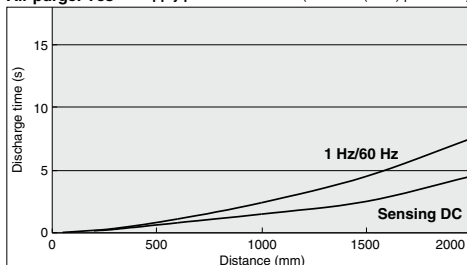

Air purge: Yes Supply pressure: 0.7 MPa (30 L/min (ANR) per nozzle)

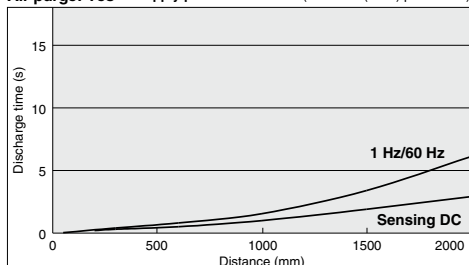

Low maintenance cartridge

⚠ Caution

Be sure to perform air purge when using a low-maintenance electrode cartridge.
Without air purge, low-maintenance effect will decrease.

Air purge: Yes Supply pressure: 0.05 MPa (3.5 L/min (ANR) per nozzle)

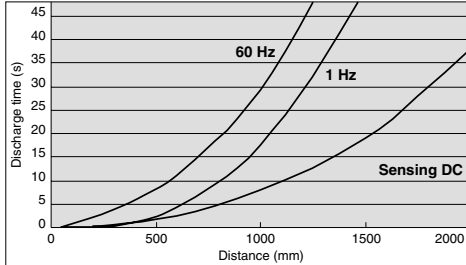

Air purge: Yes Supply pressure: 0.1 MPa (7 L/min (ANR) per nozzle)

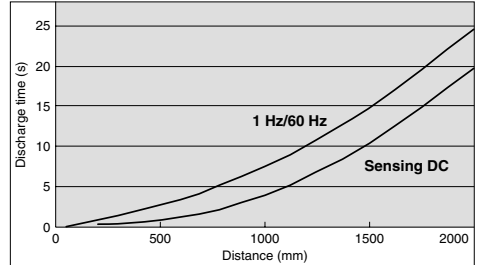

Air purge: Yes Supply pressure: 0.3 MPa (14 L/min (ANR) per nozzle)

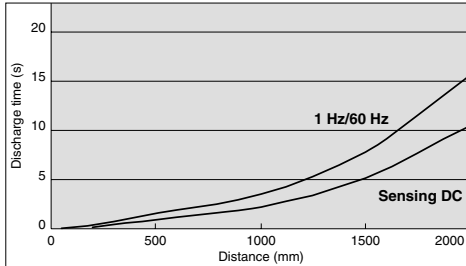

Air purge: Yes Supply pressure: 0.5 MPa (20 L/min (ANR) per nozzle)

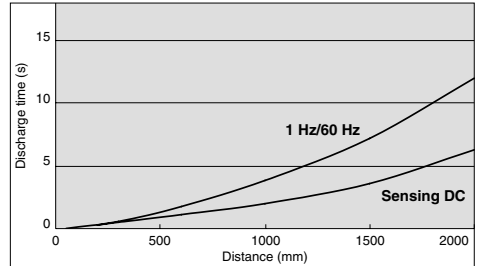

Air purge: Yes Supply pressure: 0.7 MPa (30 L/min (ANR) per nozzle)

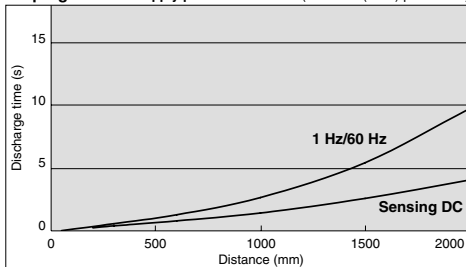

Pressure Sensor

Pressure Control

Flow Sensor

Position Detection Switch

Reduced-wiring Fieldbus System

Static Neutralization Equipment

Length Measuring/Counter

Alphabetical Index

Technical Data 2

Note) Static neutralization features are based on the data using the charged plate (size: 150 mm x 150 mm, capacitance: 20 pF) as defined in the U.S. ANSI standards (ANSI/ESD, STM3. 1-2015). Use this as a guideline purpose only for model selection because the value varies depending on the material and/or size of a subject.

Static Neutralization Characteristics

2) Static neutralization range

High speed static neutralization cartridge

Air purge: No

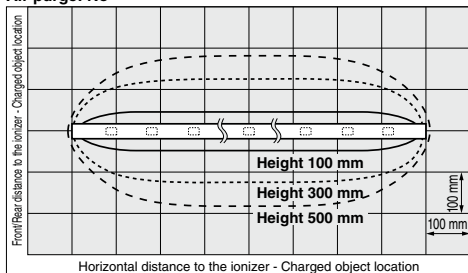

High speed static neutralization cartridge, Low maintenance cartridge

Air purge: Yes (0.05 MPa to 0.7 MPa)

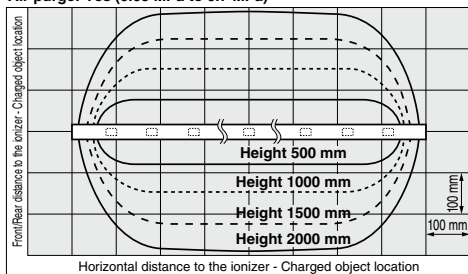

3) Installation height of feedback sensor and discharge time/Offset voltage

The height of a feedback sensor should be 50 mm or less. When using a feedback sensor at higher than 50 mm, refer to the graphs below.

Air purge: Yes (0.1 MPa)

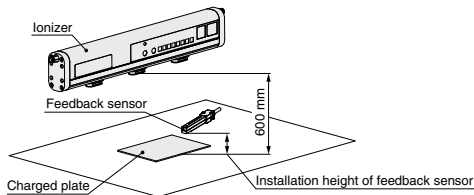
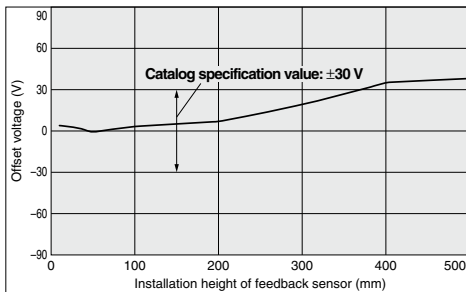
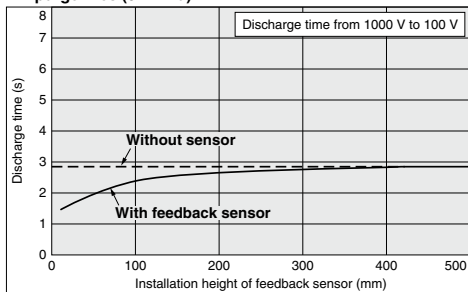

Series IZS31

Technical Data 3

Static Neutralization Characteristics

4) Flow rate — Pressure characteristics

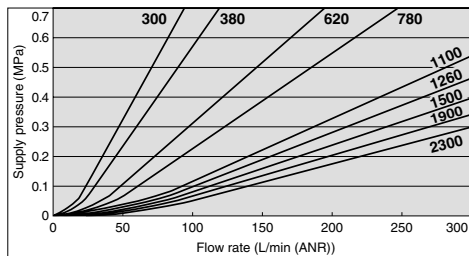

How to measure

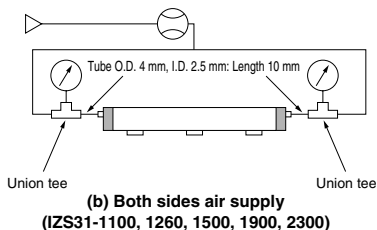
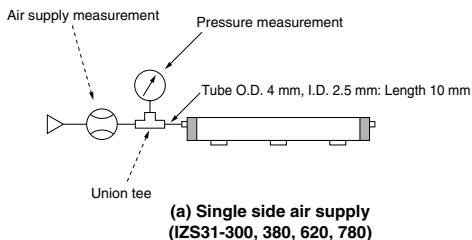

Sensor Monitor Output (When feedback sensor is used)

Note) The installation distance in the figure refers to the distance from the target to the electrostatic sensor.

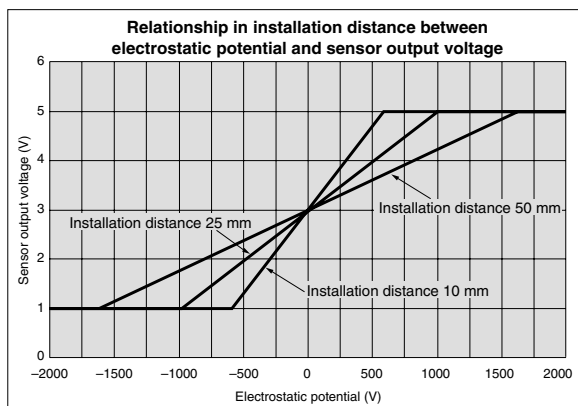

Feedback sensor detection range

The relationship between the installation distance of the electrostatic sensor and the detection range is as follows:

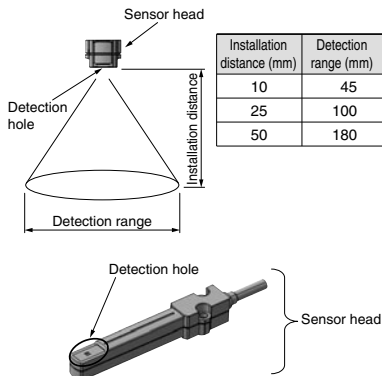

Pressure Sensor

Pressure Control

Flow Sensor

Position Detection Switch

Reduced-wiring Fieldbus System

Static Neutralization Equipment

Length Measuring/Counter

Alphabetical Index

Ionizer

Series IZS31

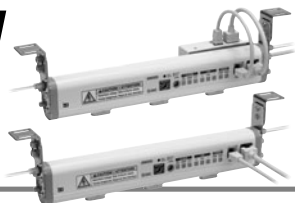

How to Order

Ionizer IZS31 - 780 [] [] [] - [] [] []

Bar type → []

Bar length → []

Emitter cartridge type/Emitter material → []

Output → []

Power supply cable → []

Sensor → []

Bracket (End bracket, Center bracket) → []

Made to Order
Refer to the below table.

Symbol	Bar length
300	300 mm
380	380 mm
620	620 mm
780	780 mm
1100	1100 mm
1260	1260 mm
1500	1500 mm
1900	1900 mm
2300	2300 mm

Symbol	Emitter cartridge type	Emitter material
Nil	Rapid neutralization of static electricity	Tungsten
C		Silicon
S		Stainless steel
J	Low maintenance	Tungsten
K		Silicon

Output	Output
Nil	NPN output
P	PNP output

Power supply cable	Power supply cable
Nil	With power supply cable (3 m)
Z	With power supply cable (10 m)
N	Without power supply cable

Sensor	Sensor
Nil	Without sensor
E	Autobalance sensor [Body-mounting type]*
F	With feedback sensor
G	Autobalance sensor [High-precision type]

* Connection cable A/B, with sensor bracket, but not assembled.

Bracket (End bracket, Center bracket)	Bracket (End bracket, Center bracket)
Nil	Without bracket
B	With bracket ^{Note)}

Note) The number of center brackets differ depending on the bar length. (Refer to the below table.)
Not assembled.

Number of brackets	End bracket	Center bracket
Bar length (mm)		
300, 380, 620, 780		None
1100, 1260, 1500	With 2 pcs.	With 1 pc.
1900, 2300		With 2 pcs.

Made to Order (Refer to page 664 through to 667 for details.)

Ionizer/Series IZS31

Symbol	Contents	Specifications
X10	Non-standard bar length (80 mm-pitch)	460, 540, 700, 860, 940, 1020, 1180, 1340, 1420, 1580, 1660, 1740, 1820, 1980, 2060, 2140, 2220
X14	Model with security cover	The main unit is shipped fitted with a security cover available as an option.
X15	Model with 40 mm-pitch emitter cartridges	This model comes fitted with emitter cartridges arranged at a 40 mm-pitch. (Standard: 80 mm-pitch) Note) Maximum bar length is 1260 mm. The air purge nozzles are arranged at an 80 mm-pitch.
X210	High-voltage/control unit detachable short type	A short type ionizer (full length of 180 mm and 220 mm) can be installed in a small space. The high-voltage unit (ionizing unit) and control unit are detachable from each other. The distance between them is also optional according to the length of selected connection cables.
X211	High-voltage/control unit detachable short type Model with 40 mm-pitch emitter cartridges	

Non-standard power supply cable length

How to Order

IZS31 - CP [] - X13

Power supply cable full length

Symbol	Cable full length
01	1 m
02	2 m
19	19 m
20	20 m

Note 1) 11 m or longer power supply cables are not CE Marking-compliant.
Note 2) Use standard power supply cables for 3 m and 10 m lengths.

Ionizer driving AC adapter (100 to 240 VAC)

How to Order

IZS31 - F [] - X196

Applicable output specifications

Nil	NPN specification
P	PNP specification

• Power can be directly supplied from an AC source.
The ionizer is driven by connection into 100 to 240 VAC.

Individual Special Order (Please contact an SMC sales representative.)

• Change in the direction of access to power supply cable
The direction of access to the power supply cable is changed to the right-hand side of the body.
Note) The power cable is connected directly to the body. A connector is not used.

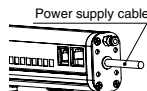

Accessories

**Feedback sensor
IZS31-DF**



**Autobalance sensor
[High-precision type]
IZS31-DG**



**Autobalance sensor
[Body-mounting type]
IZS31-DE**

- Connection cable A/B (1 pc. each)
- Sensor bracket (1 pc.)
- Hexagon socket head cap screw for sensor bracket (2 pcs.)



Accessories

Power supply cable
· IZS31-CP (3 m)
· IZS31-CPZ (10 m)



Connection cable A/B for connecting autobalance sensor to the body
· For driving:
IZS31-CF (12P)



· For I/O signals:
IZS31-CR (6P)



High speed static neutralization cartridge

- IZS31-NT (Material: Tungsten)
- IZS31-NC (Material: Silicon)
- IZS31-NS (Material: Stainless steel)



Low maintenance cartridge

- IZS31-NJ (Material: Tungsten)
- IZS31-NK (Material: Silicon)



End bracket/IZS31-BE

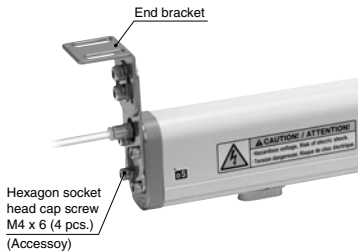

Note) The number of center brackets required, as listed below, depends on the bar length. Two end brackets are always required regardless of the bar length.

Bar length (mm)	Quantity	
	End bracket	Center bracket
300, 380, 620, 780	2 pcs.	None
1100, 1260, 1500		With 1 pc.
1900, 2300		With 2 pcs.

Note) The model number is for a single bracket.

Center bracket/IZS31-BM

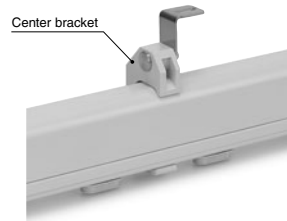

**Sensor bracket/IZS31-BL
(For mounting IZS31-DE on the body)**

* Provided with 2 hexagon socket head cap screw for sensor bracket (2 pcs.)

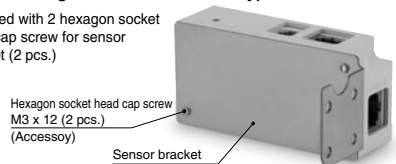

Pressure Sensor

Pressure Control

Flow Sensor

Position Detection Switch

Reduced-wiring Fieldbus System

Static Neutralization Equipment

Length Measuring/Counter

Alphabetical Index

Series IZS31

Options

Security cover

IZS31-E 3

Number of fixed emitter cartridges

IZS31-E3	3
IZS31-E4	4
IZS31-E5	5

Number of required security covers

Bar length (mm)	Number of required security covers		
	IZS31-E3	IZS31-E4	IZS31-E5
300	1	—	—
380	—	1	—
620	1	1	—
780	—	1	1
1100	3	1	—
1260	1	3	—
1500	—	2	2
1900	1	5	—
2300	—	2	4

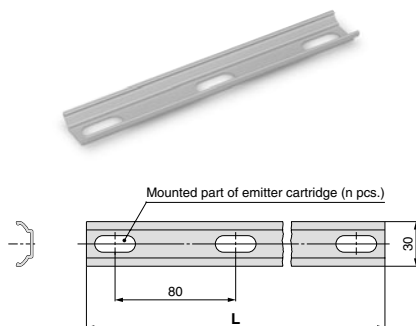

Part no	L
IZS31-E3	200
IZS31-E4	280
IZS31-E5	360

The model number requires the suffix “-X14” to indicate that the body is to be shipped fitted with a security cover.

IZS31 Standard part no. - X14

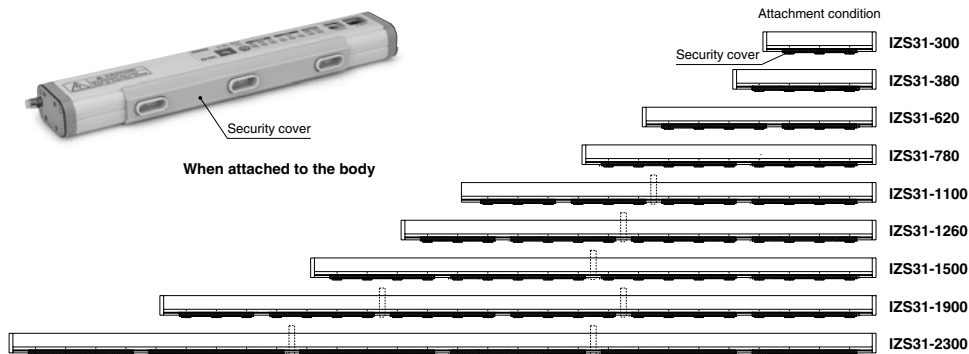

Screwdriver for balance adjustment trimmer/IZS30-M1



Cleaning kit/IZS30-M2



Specifications

Ionizer model		IZS31-□□ (NPN specification)	IZS31-□□□ (PNP specification)
Ion generation method		Corona discharge type	
Method of applying voltage		Sensing DC, Pulse DC, DC	
Electricity discharge output		±7000 V	
Offset voltage <small>Note 1)</small>		Within ±30 V (Stainless steel emitter: Within ±100 V)	
Air purge	Fluid	Air (Clean and dry)	
	Operating pressure	0.7 MPa or less <small>Note 2)</small>	
	Connecting tubing O.D.	ø4	
Power supply voltage		21.6 to 26.4 VDC (Within 24 VDC ±10%)	
Current consumption	Sensing DC mode	200 mA or less (While standing by: 120 mA or less)	
	Pulse DC mode	Autobalance sensor [Body-mounting type]: 300 mA or less Autobalance sensor [High-precision type]: 200 mA or less When sensor is not used: 170 mA or less	
	DC mode	170 mA or less	
Input signal	Discharge stop signal	Connected to 0 V (Voltage: 5 VDC or less, Current consumption: 5 mA or less)	Connected to +24 VDC (Voltage: Between 19 VDC and power supply voltage, Current consumption: 5 mA or less)
	Maintenance detection signal		
Output signal	Static electricity removal completion signal	Max. load current: 100 mA Residual voltage: 1 V or less (Load current at 100 mA) Max. applied voltage: 28 VDC	Max. load current: 100 mA Residual voltage: 1 V or less (Load current at 100 mA)
	Maintenance detection signal		
	Error signal		
	Sensor monitor output <small>Note 3)</small>	Voltage output 1 to 5 V (Connect a 10 kΩ or larger load.) 50 to 2000 mm (Sensing DC mode: 200 to 2000 mm)	
Effective distance of static neutralization		50 to 2000 mm (Sensing DC mode: 200 to 2000 mm)	
Ambient temperature, Fluid temperature		0 to 50°C	
Ambient humidity		35 to 80% Rh (No condensation)	
Material		Cover of ionizer: ABS, Emitter: Tungsten, Single crystal silicon, Stainless steel	
Vibration resistance		Durability 50 Hz Amplitude 1 mm XYZ each 2 hours	
Impact resistance		10 G	
Compliance with overseas standards/directive		CE (EMC directive: 2004/108/EC) UL U.S. Standard for Electrostatic Air Cleaner, UL867, fourth edition CSA Canadian Standard for Electrostatic Air Cleaner, CAN/CSA C22.2 No.187-M1986	

Note 1) When the air purge is performed between a charged object and an ionizer at a distance of 300 mm

Note 2) When the low maintenance cartridge is used, the operating pressure must be 0.05 MPa or more.

Note 3) When the potential of a charged object is measured by a feedback sensor, the relationship between the potential being measured and the sensor monitor output voltage, and the detection range of the sensor vary depending on the sensor's installation distance. Refer to page 641.

Number of Emitter Cartridges/Weight

Bar length (mm)	300	380	620	780	1100	1260	1500	1900	2300
Number of emitter cartridges	3	4	7	9	13	15	18	23	28
Weight (g)	470	530	720	850	1100	1220	1410	1730	2040

Sensor

Sensor model	IZS31-DF (Feedback sensor)	IZS31-DG (Autobalance sensor [High-precision type])	IZS31-DE (Autobalance sensor [Body-mounting type])
Ambient temperature	0 to 50°C		
Ambient humidity	35 to 85% Rh (No condensation)		
Case material	ABS	ABS, Stainless steel	ABS
Vibration resistance	Durability 50 Hz Amplitude 1 mm XYZ each 2 hours		
Shock resistance	10 G		
Weight	200 g (Including cable weight)	220 g (Including cable weight)	110 g (Including cable weight)
Installation distance	10 to 50 mm (Recommended)		
Compliance with overseas standards/directive	CE (EMC directive: 2004/108/EC, Low voltage directive: 73/23/EEC, 93/68/EEC)		

Construction

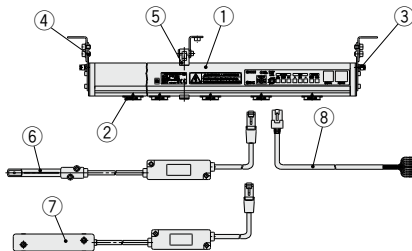

No.	Description
1	Ionizer
2	Emitter cartridge
3	One-touch fitting
4	End bracket
5	Center bracket
6	Feedback sensor
7	Autobalance sensor [High-precision type]
8	Power supply cable
9	Autobalance sensor [Body-mounting type]
10	Connection cable A (12P)
11	Connection cable B (6P)
12	Sensor bracket

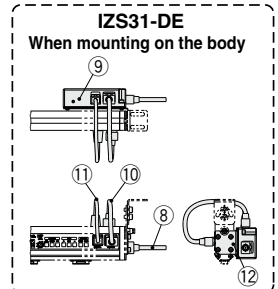

Functions

1. Run mode

There are 3 different run modes (Sensing DC mode/Pulse DC mode/DC mode) for the IZS31, which can be selected based on the application and operating condition.

(1) Sensing DC mode

The discharge time is reduced by detecting the workpiece's charge condition with a feedback sensor which feeds the data back to the ionizer and causes ions with the polarity best suited for static neutralization to emit. The static neutralization completion signal turns off when the workpiece's electrostatic potential falls within ± 30 V. ^{Note)}

This mode is suited for neutralizing static electricity from heavily charged workpieces.

Either "Energy Saving Run" or "Continuous Static Neutralization Run" can be selected depending on the ionizer's operation after static neutralization is completed.

Energy saving run	The ionizer stops discharging automatically after the of static neutralization is completed. It resumes discharging when the workpiece's electrostatic potential becomes outside of ± 30 V. ^{Note)} For static neutralization from conductive workpieces, "Energy Saving Run" is recommended.
Continuous static neutralization run	Even after the completion of static neutralization, this method continues to neutralize static electricity using DC pulses while feeding back the data, so that the workpiece's electrostatic potential falls within ± 30 V. ^{Note)} For static neutralization from nonconductive workpieces, "Continuous Static Neutralization Run" is recommended.

Note) When the feedback sensor is installed at a height of 25 mm.

(2) Pulse DC mode

Alternatively emits positive and negative ions.

● When an autobalance sensor (high-precision type) is used.

The ionizer automatically adjusts the offset voltage of the static neutralization area to within ± 30 V. If the offset voltage exceeds ± 30 V due to contamination of the emitter, the ionizer outputs the maintenance output signal. The offset voltage can be adjusted and maintained at the workpiece position.

Either "Manual Run" or "Automatic Run" can be selected depending on the operating method of the offset voltage adjustment.

Manual run	When the maintenance detection signal is input, or the ionizer is turned ON, the offset voltage of the static neutralization area is adjusted. In the case of the static neutralization of a moving workpiece, "Manual Run" is recommended. Start the operation of the system after the offset voltage is adjusted.
Automatic run	This method continuously adjusts the offset voltage. For static neutralization from stationary workpieces or prescribed spatial static neutralization, "Automatic Run" is recommended.

● When an autobalance sensor (body-mounting type) is used.

Controls to keep the initial offset voltage. If the offset voltage cannot be kept due to emitter contamination, the ionizer outputs a maintenance detection signal. Use a balance adjustment trimmer to set the offset voltage (requires a separate measuring instrument to verify the offset voltage).

Autobalance sensor [Body-mounting type]

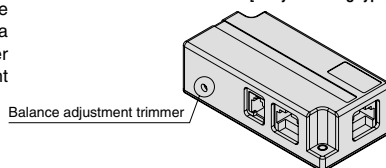

● When a sensor is not used.

Use a balance adjustment trimmer to adjust the offset voltage. This requires the separate use of a measuring instrument to verify the offset voltage.

(3) DC mode

Continuously emits positive and negative ions. Parts other than the object need to be appropriately grounded to prevent from being charged. This mode cannot emit both positive and negative ions at the same time.

Functions

2. Maintenance detection

When a maintenance detection signal is input, the ionizer detects any deterioration that may interfere with the emitters' capability to neutralize static electricity. If the emitters need to be cleaned due to such deterioration, the maintenance detection indicator LED comes on and a maintenance detection signal turns ON. Ion emission continues even if the maintenance detection signal is turned ON.

Note) Deterioration in static electricity neutralization capability cannot be detected by only connecting a feedback sensor, autobalance sensor [high-precision type], or autobalance sensor [body-mounting type]. Verify the capability by periodically inputting a maintenance start signal.

3. Indicator description

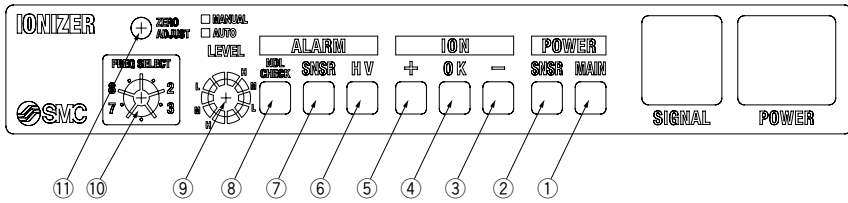

No.	Description	Type	Contents
1	Power supply indicator	LED (Dark green)	Illuminates when power is supplied. Flashes when the supply voltage is irregular.
2	Sensor indicator	LED (Dark green)	Illuminates when the feedback sensor, autobalance sensor [high-precision type], or autobalance sensor [body-mounting type] is connected.
3	Negative indicator	LED (Blue)	Functionality differs depending on the run mode. Refer to "Model Selection and Settings" on page 650, 654, 657.
4	Completion indicator	LED (Dark green)	
5	Positive indicator	LED (Orange)	
6	Irregular high-voltage indicator	LED (Red)	Illuminates when an irregular current flows through an emitter.
7	Irregular sensor indicator	LED (Red)	Illuminates when the feedback sensor, autobalance sensor [high-precision type], or autobalance sensor [body-mounting type] is not operating normally.
8	Maintenance detection indicator	LED (Red)	Illuminates when the emitter contamination is detected. Flashes when the maintenance detection is in progress.
9	Maintenance level selection switch	Rotary switch	Functionality differs depending on the run mode.
10	Frequency selection switch	Rotary switch	Refer to "Model Selection and Settings" on page 648, 652, 653, 656.
11	Balance adjustment trimmer	Trimmer	Adjusts the offset voltage when the autobalance sensor [high-precision type] or autobalance sensor [body-mounting type] is not used.

Pressure Sensor

Pressure Control

Flow Sensor

Position Detection Switch

Reduced-wiring Fieldbus System

Static Neutralization Equipment

Length Measuring/Counter

Alphabetical Index

Model Selection and Settings 1/Sensing DC Mode

1. **Sensing DC mode** (Refer to page 652 when using the ionizer in the pulse DC mode, or refer to page 656 when using it in the DC mode.)

1) Bar length selection

- Select the appropriate length suited for a work size by referring to “Static Neutralization Characteristics” and “Static Neutralization Range”, etc.

2) Ionizer installation

- Install the ionizer within 200 to 2000 mm. Although the ionizer can also be used at other distances, it may fail to operate normally depending on the conditions of use. Before use, always verify that the ionizer is functioning normally.

3) Sensor installation

- Install the feedback sensor with the detection hole facing the charged surface.
- Installation at a height from 10 to 50 mm is recommended. Although the sensor can also be used at other heights, it may fail to operate normally depending on the conditions of use. Before use, always verify that the sensor operates normally. (Refer to “Installation height of feedback sensor and discharge time/Offset voltage” on page 640 as a guide.)
- When the ionizer and feedback sensor are connected, the sensing DC mode is automatically selected.

4) Maintenance detection level setting

- Select the detection level of the maintenance period of the emitter with the maintenance detection level selection switch.
- Set the switch to either H (High), M (Middle), L (Low). At settings other than these, the ionizer does not perform the emitter stain-detection.



- H (High).....Level that does not affect the discharge time.
- M (Middle).... Level at which the discharge time is a little bit longer than it was initially.
- L (Low)..... Level that gives the alarm before static neutralization cannot be performed.

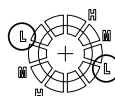

* Settings with the same letter share the same level.

Note) Stain-detection starts when a maintenance start signal is input.

5) Frequency selection switch setting

- Select “Energy Saving Run” or “Continuous Static Neutralization Run”.
- In case of “Continuous Static Neutralization Run”, select the ion generation frequency after static neutralization is completed.

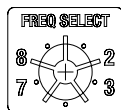

		Details of operation	Switch setting
Energy saving run	Automatically stops emitting electricity even after static neutralization is completed.		
Continuous static neutralization run	Continuously neutralizes static electricity with pulse DC by controlling the offset voltage so that the charged potential on a workpiece would be within $\pm 30V$ even after static neutralization is completed. The ionizer generates ions at the preset frequency.	<p>(Example) Charged object workpiece: negative electric charge</p> <p>Static neutralization completion</p>	<ul style="list-style-type: none"> 0...1 Hz 1...3 Hz 2...5 Hz 3...10 Hz 4...15 Hz 5...20 Hz 6...30 Hz 7...60 Hz

Model Selection and Settings 1/Sensing DC Mode

6) Wiring of power supply cable

- Connect the dedicated power supply cable.
- Refer to the dimensions of the power supply cable/IZS31-CP on page 662 for the cable specifications.

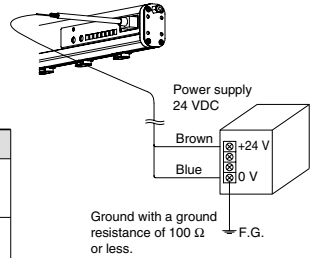

■ Connection with ionizer driving power supply

Symbol	Cable color	Description	Connection needs	Contents
DC1(+)	Brown	+24 VDC	○	Ionizer driving power supply
DC1(-)	Blue	0 V	○	
OUT4	Dark green	Sensor monitor output	△	Outputs the workpiece's electrostatic potential as an analog signal. (1 to 5 V)

* Be sure to ground the DC1 (-) [Blue] with a ground resistance of 100 Ω or less. If the terminal is not grounded, the ionizer may malfunction.

■ Connection with input/output signal power supply

Symbol	Cable color	Description	Connection needs	Contents
DC2(+)	Red	+24 VDC	○	Input/Output signal power cable
DC2(-)	Black	0 V	○	
IN1	Light green	Discharge stop signal	○	Signal for ionizer run/stop (NPN) Turned to the run mode when connected to DC2 (-). [Black] (PNP) Turned to the run mode when connected to DC2 (+). [Red]
IN2	Gray	Maintenance detection signal	△	Input signal when determining the necessity of emitter maintenance
—	White	—	—	—
—	Orange	—	—	—
OUT1	Pink	Static neutralization completion signal	△	Turned ON when the workpiece's electrostatic potential is within ±30 V or when the emitter contamination is being detected.
OUT2	Yellow	Maintenance detection signal	△	Turned ON when the emitter maintenance is necessary.
OUT3	Purple	Irregular signal	△	Turned ON in normal operation. Turned OFF in case of high-voltage error, sensor error, CPU error.

○: Minimum wiring requirement for ionizer operation

△: Wiring necessary to use various functions

—: Wiring not required in the sensing DC mode. Exercise caution to ensure that this wire does not short-circuit to other wires.

7) Air piping

- For single-side piping, block the unused port with the M-5P plug supplied with the ionizer.

Model Selection and Settings 1/Sensing DC Mode

8) LED indicators

- **POWER LED**...Indicates the state of power supply input and sensor LED connection.

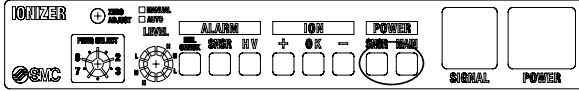

LED		Function
POWER	MAIN	Illuminates when power is supplied. (Dark green) (Flashes when the power supply is irregular.)
	SNSR	Illuminates when the feedback sensor is connected. (Dark green)

- **ION LED**...Indicates the workpiece's state of electrostatic charging.

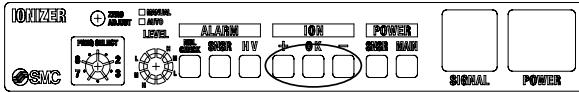

LED		Function
ION	+	Illuminates when the workpiece is positively charged. (Orange)
	OK	Illuminates when the workpiece electrostatic potential is low. (Dark green)
	-	Illuminates when the workpiece is negatively charged. (Blue)

- The workpiece's state of electrostatic charge can be checked by reading the LED indicators.

Workpiece electric polarity	LED + OK -	Workpiece electric charge voltage	
Positive ↑ Static neutralization completion ↓ Negative	■ □ □	+400 V or higher	■ Light ON ■ Flash at 4 Hz □ Light OFF
	■ □ □	+100 V to +400 V	
	■ ■ □	+30 V to +100 V	
	□ ■ □	Within ±30 V	
	□ ■ ■	-30 V to -100 V	
	□ □ ■	-100 V to -400 V	
	□ □ ■	-400 V or lower	

- **ALARM LED**...Indicates abnormal states of the ionizer.

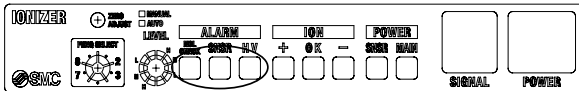

LED		Function
ALARM	HV	Illuminates when an abnormal current flows due to a short circuit of the emitter. (Red)
	SNSR	Illuminates when the feedback sensor is not operating normally. (Red)
	NDL CHECK	Illuminates when contamination of the emitter is detected. (Red) (Flashes when the maintenance detection is in progress.)

Model Selection and Settings 1/Sensing DC Mode

9) Alarm

Alarm item	Description	Corrective actions
High-voltage error	Gives notification of the occurrence of an abnormal current, such as a short circuit of the emitter. The ionizer stops ion emission, turns on the HV ALARM indicator, and turns OFF the error signal (OUT3).	Turn OFF the power supply, solve the problem, then turn the power supply on again. Alternatively, turn the discharge stop signal (IN1) OFF, then ON.
Sensor error	Gives notification that the feedback sensor has become unable to operate normally. The ionizer stops ion emission, turns on the SNSR ALARM indicator, and turns OFF the error signal (OUT3).	Turn OFF the power supply, solve the problem, then turn the power supply on again. Alternatively, turn the discharge stop signal (IN1) OFF, then ON.
CPU error	Gives notification of the occurrence of a failure in the CPU due to noise, etc. The ionizer stops ion emission, all of the LED indicators flash, and turns OFF the error signal (OUT3).	Turn OFF the power supply, solve the problem, then turn the power supply on again. Alternatively, turn the discharge stop signal (IN1) OFF, then ON.
Maintenance detection	Gives notification that the emitter maintenance is necessary. The NDL CHECK ALARM indicator comes on and a maintenance output signal (OUT2) turns ON.	Turn OFF the power supply, clean or replace the emitters, and turn the power supply on again.

10) Timing chart

■ Timing chart in normal operation

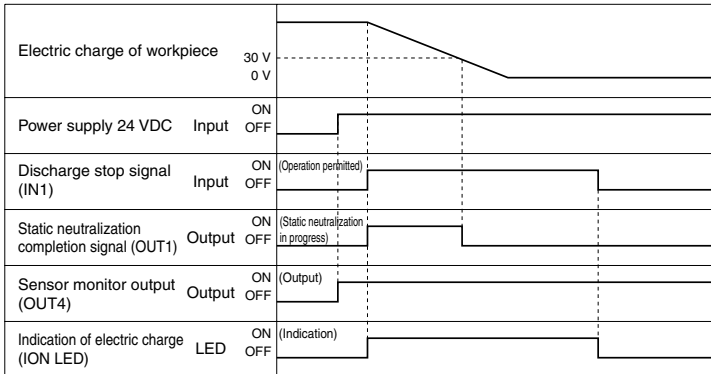

■ Timing chart when the maintenance is detected.

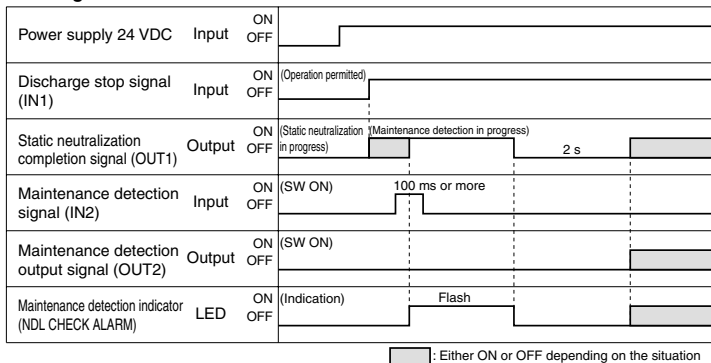

■: Either ON or OFF depending on the situation

· Static neutralization completion signal is turn ON when the maintenance detection is in progress.

⚠ Caution

Ions are emitted from the ionizer when the the maintenance detection is in progress and the workpiece may therefore be electrostatically charged. Perform this detection procedure in the absence of workpieces.

Pressure Sensor
Pressure Control
Flow Sensor
Position Detection Switch
Reduced-wiring Fieldbus System
Static Neutralization Equipment
Length Measuring/Counter
Alphabetical Index

Model Selection and Settings 2/Pulse DC Mode

2. Pulse DC mode

1) Bar length selection

- Select the appropriate length suited for a work size by referring to “Static Neutralization Characteristics” and “Static Neutralization Range”, etc.

2) Ionizer installation

- Install the ionizer within 50 to 2000 mm of the object requiring static neutralization. However, install the ionizer at a distance from 100 to 2000 mm when using an autobalance sensor [high-precision type]. Although the ionizer can also be used at other distances, it may fail to operate normally depending on the conditions of use. Before use, always verify that the ionizer is functioning normally.

3) Sensor installation

Autobalance sensor [High-precision type]

- When adjusting the offset voltage using a high-precision type sensor, install the sensor immediately below the ionizer so that it is close to the workpiece.
- When an autobalance sensor is connected, settings of the balance adjustment trimmer on the body are nullified.

Autobalance sensor [Body-mounting type]

- When adjusting the offset voltage using a body-mounting type sensor, fix it to the ionizer with a bracket and then use the connection cables A and B to connect the ionizer and sensor.
- When an autobalance sensor is connected, settings of the balance adjustment trimmer on the body are nullified.

4) Maintenance detection level selection switch setting

Autobalance sensor [High-precision type]

- Select “Manual Run” or “Automatic Run” when an autobalance sensor [high-precision type] is connected to adjust the offset voltage.

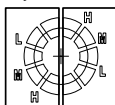

AUTO MANUAL

Details of operation		Switch setting
Manual run	When a maintenance detection signal is input, or the ionizer is turned ON, the maintenance detection of the emitter is executed according to the offset voltage adjustment and detection level setting. The offset voltage adjustment value for each ion generation frequency is maintained. When the ion generation frequency is changed, adjust the offset voltage. After the adjustment, the autobalance sensor can be removed as the adjustment of the offset voltage will not be executed until the maintenance start signal is input again.	MANUAL
Automatic run	The ionizer continuously adjusts the offset voltage. When the autobalance sensor is removed, adjust the offset voltage manually using the balance adjustment trimmer.	AUTO

* Set the switch to H, M or L according to the maintenance detection level.

Autobalance sensor [Body-mounting type]

Configuration is not necessary.

5) Offset voltage adjustment

Autobalance sensor [High-precision type]

When the autobalance sensor is used, the ionizer automatically adjusts the offset voltage near the sensor installation location to within ± 30 V.

Either “Manual Run” or “Automatic Run” can be selected depending on the method of offset voltage adjustment.

Manual run	When a maintenance detection signal is input or the ionizer is turned ON, this method adjusts the offset voltage. For static neutralization from moving workpieces, “Manual Run” is recommended. Start system operation after offset voltage adjustment is completed.
Automatic run	This method continuously adjusts the offset voltage. For static neutralization from stationary workpieces or prescribed spatial static neutralization, “Automatic Run” is recommended.

Autobalance sensor [Body-mounting type]

Control to keep the initial offset voltage.

When changing the offset voltage settings, use an offset voltage adjustment trimmer on the autobalance sensor (requires a separate measuring instrument to verify the offset voltage).

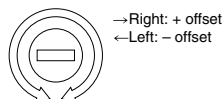

A balance adjustment trimmer is turned two full turns.

Model Selection and Settings 2/Pulse DC Mode

■ When a sensor is not used.

When an autobalance sensor is not used, set the switch to AUTO. Then, adjust the offset voltage manually using the balance adjustment trimmer on the body.

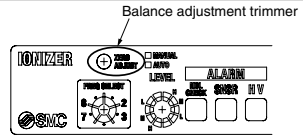

- Set the maintenance detection level.
- Set the switch to either H (High), M (Middle), L (Low). At settings other than these, the ionizer does not perform the maintenance detection.

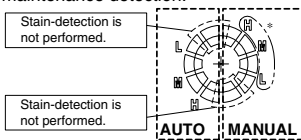

- H (High).....Level that does not affect the discharge time.
- M (Middle).....Level at which the discharge time is a little bit longer than it was initially.
- L (Low).....Level that gives the alarm before static neutralization cannot be performed.

* When an autobalance sensor is used, select the switch based on the operation mode.
Example: When adjusting the offset voltage in the manual run using an autobalance sensor, select a maintenance level of H, M, L on the MANUAL side.

- Maintenance detection starts when a maintenance detection signal is input.
- When the switch is set to H, M, L, the ionizer performs the maintenance detection and then the offset voltage adjustment.

6) Frequency selection switch setting

- Select the ion generation frequency.



Ion generation frequency	Switch setting
1 Hz	0
3 Hz	1
5 Hz	2
10 Hz	3
15 Hz	4
20 Hz	5
30 Hz	6
60 Hz	7

7) Wiring of power supply cable

- Connect the dedicated power supply cable.

■ Connection with ionizer driving power supply

Symbol	Cable color	Description	Connection needs		Contents
			High-precision type	Body-mounting type	
DC1(+)	Brown	+24 VDC	○	—	Ionizer driving power cable
DC1(-)	Blue	0 V [FG]*	○	○ [FG]	
OUT4	Dark green	Sensor monitor output	—	—	—

* When a high-precision type sensor is used, connect DC1 (-) [Blue] to the power supply 0 V and be sure to ground with a ground resistance of 100 Ω or less. If the lead is not grounded, the ionizer may malfunction.

* When a body-mounting type sensor is used, do not connect DC1 (-) [Blue] to the power supply 0 V and be sure to ground with a ground resistance of 100 Ω or less. In case of connecting the lead to the power supply 0 V and grounding with a ground resistance of 100 Ω or less, all I/O signals are not insulated from the FG terminal.

■ Connection with input/output signal power supply

Symbol	Cable color	Description	Connection needs		Contents
			High-precision type	Body-mounting type	
DC2 (+)	Red	+24 VDC	○	○	Input/Output signal power cable
DC2 (-)	Black	0 V	○	○	
IN1	Light green	Discharge stop signal	○	○	Signal for ionizer run/stop (NPN) Turned to the run mode when connected to DC2 (-). [Black] (PNP) Turned to the run mode when connected to DC2 (+).
IN2	Gray	Maintenance detection signal	△	△	Input signal when determining the necessity of emitter maintenance
—	White	—	—	—	—
—	Orange	—	—	—	—
OUT1	Pink	Static neutralization completion signal	△	△	Outputs when the maintenance detection of the emitters is in progress.
OUT2	Yellow	Maintenance detection signal	△	△	Outputs when the emitter maintenance is necessary.
OUT3	Purple	Irregular signal	△	△	Outputs in case of high-voltage error, sensor error, CPU error. (B contact output)

○: Minimum wiring requirement for ionizer operation

△: Wiring necessary to use various functions

—: Wiring not required in the sensing DC mode. Exercise caution to ensure that this wire does not short-circuit to other wires.

⚠ Caution

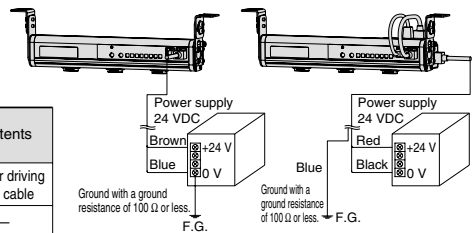

Ground with a ground resistance of 100 Ω or less after connecting the DC1 (-) lead (Blue) of the power supply cable to the power supply 0 V.

Autobalance sensor [High-precision type]

Ground with a ground resistance of 100 Ω or less without connecting the DC1 (-) lead (Blue) of the power supply cable to the power supply 0 V.

Autobalance sensor [Body-mounting type]

Pressure Sensor

Pressure Control

Flow Sensor

Position Detection Switch

Reduced-wiring Fiberglass System

Static Neutralization Equipment

Length Measuring/Counter

Alphabetical Index

Model Selection and Settings 2/Pulse DC Mode

8) Air piping

- For single-side piping, block the unused port with the M-5P plug supplied with the ionizer.

9) LED indicators

- POWER LED**...Indicates the state of power input and sensor connection.

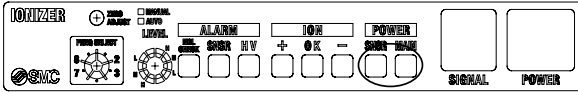

LED		Function
POWER	MAIN	Illuminates when power is supplied. (Dark green) (Flashes when the power supply is irregular.)
	SNSR	Illuminates when an autobalance sensor [high-precision type or body-mounting type] is connected. (Dark green)

- ION LED**...Indicates the polarity of ions being emitted and the state of offset voltage.

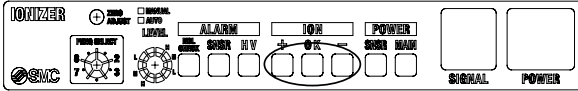

LED		Function
ION	+	Illuminates that positive ions are being emitted from the ionizer. (Orange)
	OK	When an autobalance sensor [high-precision type] is used, it indicates the state of offset voltage. (Refer to the table below.) Light OFF when a sensor is not used, or an autobalance sensor [body-mounting type] is used.
	-	Illuminates that negative ions are being emitted from the ionizer. (Blue)

- When an autobalance sensor [high-precision type] is used, the state of offset voltage can be checked by reading the LED indicator.

Offset voltage	OK LED
Under ± 30 V	Dark green light ON (or Flash)
± 30 V or more	Light OFF

* The OK LED indicator flashes when the offset voltage is approaching the limits of the adjustable range, signaling that the time for emitter maintenance is approaching.

- ALARM LED**...Indicates abnormal states of the ionizer.

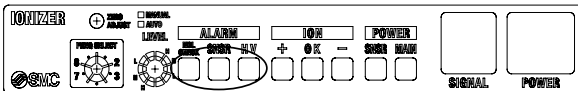

LED		Function
ALARM	HV	Illuminates when an abnormal current flows due to a short circuit of the emitter. (Red)
	SNSR	Illuminates when the autobalance sensor [high-precision type] is not operating normally. (Red)
	NDL CHECK	Illuminates when the sensor detects a necessity to perform maintenance of the emitter. (Red) (Flashes when the maintenance detection is in progress.)

Model Selection and Settings 2/Pulse DC Mode

10) Alarm

Alarm item	Description	Corrective actions
High-voltage error	Gives notification of the occurrence of an abnormal current, such as a short circuit of the emitter. The ionizer stops ion emission, turns on the HV ALARM indicator, and turns OFF the error signal (OUT3).	Turn OFF the power supply, solve the problem, then turn the power supply on again. Alternatively, turn the discharge stop signal (IN1) OFF, then ON.
Sensor error	Gives notification that the autobalance sensor (high-precision type or body-mounting type) has become unable to operate normally. The ionizer stops ion emission, turns on the SNSR ALARM indicator, and turns OFF the error signal (OUT3).	Turn OFF the power supply, solve the problem, then turn the power supply on again. Alternatively, turn the discharge stop signal (IN1) OFF, then ON.
CPU error	Gives notification of the occurrence of a failure in the CPU due to noise, etc. The ionizer stops ion emission, all of the LED indicators flash, and turns OFF the error signal (OUT3).	Turn OFF the power supply, solve the problem, then turn the power supply on again. Alternatively, turn the discharge stop signal (IN1) OFF, then ON.
Maintenance detection	Gives notification that the emitter maintenance is necessary. The NDL CHECK ALARM indicator comes on and a maintenance detection signal (OUT2) turns ON. * Ions are continuously emitted.	Turn OFF the power supply, clean or replace the emitters, and turn the power supply on again. After turning power supply on, adjust the offset voltage.

11) Timing chart

■ Timing chart in normal operation

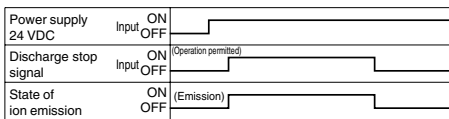

■ Timing chart when the maintenance detection is performed or offset voltage is adjusted.

(a) When an autobalance sensor [high-precision type] is connected.

(1) Manual run

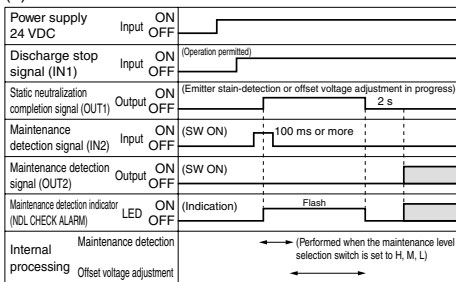

(2) Automatic run

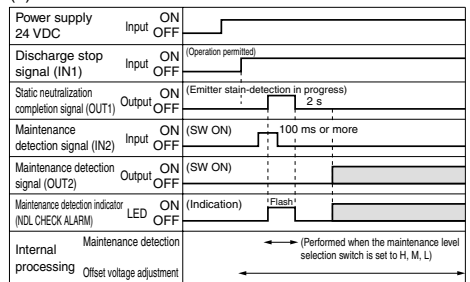

(b) When an autobalance sensor

[body-mounting type] is connected.

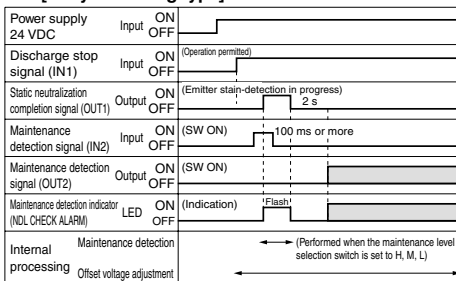

(c) When a sensor is not connected.

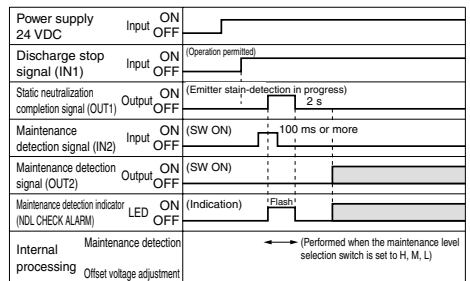

□ : Either ON or OFF depending on the situation

· Static neutralization completion signal is turn ON when the maintenance detection is in progress.

⚠ Caution

Ions are emitted from the ionizer when the the maintenance detection is in progress and the workpiece may therefore be electrostatically charged. Perform this detection procedure in the absence of workpieces.

Model Selection and Settings 3/DC Mode

3. DC mode

1) Bar length selection

- Select the appropriate length suited for a work size by referring to “Static Neutralization Characteristics” and “Static Neutralization Range”, etc.

2) Ionizer installation

- Install the ionizer within 50 to 2000 mm of the object requiring static neutralization. Although the ionizer can also be used at other distances, it may fail to operate normally depending on the conditions of use. Before use, always verify that the ionizer is functioning normally.

3) Frequency selection switch setting

- Select “Positive Ion Emission” or “Negative Ion Emission”.

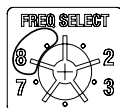

Ion polarity	Switch setting
Positive ion emission	8
Negative ion emission	9

4) Wiring of power supply cable

- Connect the dedicated power supply cable.

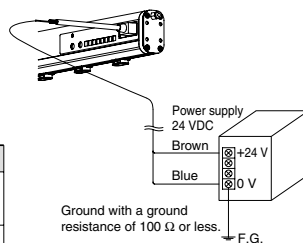

■ Connection with ionizer driving power supply

Symbol	Cable color	Description	Connection needs	Contents
DC1 (+)	Brown	+24 VDC	○	Ionizer driving power cable
DC1 (-)	Blue	0 V [FG]	○	
OUT4	Dark green	Sensor monitor output	—	—

* Be sure to ground the DC1 (-) [Blue] with a ground resistance of 100 Ω or less. If the terminal is not grounded, the ionizer may malfunction.

■ Connection with input/output signal power supply

Symbol	Cable color	Description	Connection needs	Contents
DC2(+)	Red	+24 VDC	○	Input/Output signal power cable
DC2(-)	Black	0 V	○	
IN1	Light green	Discharge stop signal	○	Signal for ionizer run/stop (NPN spec.) Turned to the run mode when connected to DC2 (-). [Black] (PNP spec.) Turned to the run mode when connected to DC2 (+). [Red]
IN2	Gray	Maintenance detection start signal	—	—
—	White	—	—	—
—	Orange	—	—	—
OUT1	Pink	Static neutralization completion signal	—	—
OUT2	Yellow	Maintenance detection output signal	—	—
OUT3	Purple	Irregular signal	△	Turned ON in normal operation. Turned OFF in case of high-voltage error, CPU error.

○ : Minimum wiring requirement for ionizer operation

△ : Wiring necessary to use various functions

— : Wiring not required in the sensing DC mode. Exercise caution to ensure that this wire does not short-circuit to other wires.

5) Air piping

- For single-side piping, block the unused port with the plug (M-5P-X112) supplied with the ionizer.

Model Selection and Settings 3/DC Mode

6) LED indicators

■ **POWER LED**...Indicates the state of power input and sensor connection.

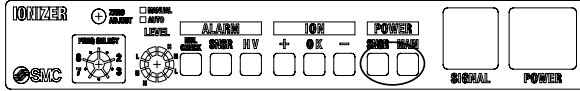

LED	Function	
POWER	MAIN	Illuminates when power is supplied. (Dark green) (Flashes when the power supply is irregular.)
	SNSR	Light OFF

■ **ION LED**...Indicates the polarity of ions being emitted.

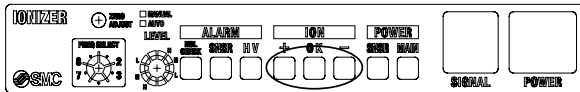

LED	Function	
ION	+	Illuminates that positive ions are being emitted from the ionizer. (Orange)
	OK	Light OFF
	-	Illuminates that negative ions are being emitted from the ionizer. (Blue)

■ **ALARM LED**...Indicates abnormal states of the ionizer.

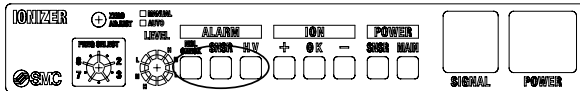

LED	Function	
ALARM	HV	Illuminates when an abnormal current flows due to a short circuit of the emitter. (Red)
	SNSR	Light OFF
	NDL CHECK	Light OFF

7) Alarm

Alarm item	Description	Corrective actions
High-voltage error	Gives notification of the occurrence of an abnormal current, such as a short circuit of the emitter. The ionizer stops ion emission, turns on the HV ALARM indicator, and turns OFF an error signal (OUT3).	Turn OFF the power supply, solve the problem, then turn the power supply on again. Alternatively, turn the discharge stop signal (IN1) OFF, then ON.
CPU error	Gives notification of the occurrence of a failure in the CPU due to noise, etc. The ionizer stops ion emission, all of the LED indicators flash, and turns OFF an error signal (OUT3).	Turn OFF the power supply, solve the problem, then turn the power supply on again. Alternatively, turn the discharge stop signal (IN1) OFF, then ON.

8) Timing chart

■ **Timing chart in normal operation**

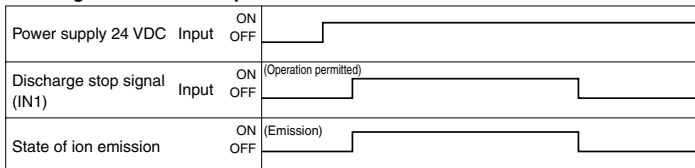

Circuit of Power Supply Cable Connection

(1) When a sensor is not used./When a feedback sensor or autobalance sensor [high-precision type] is used.

NPN output

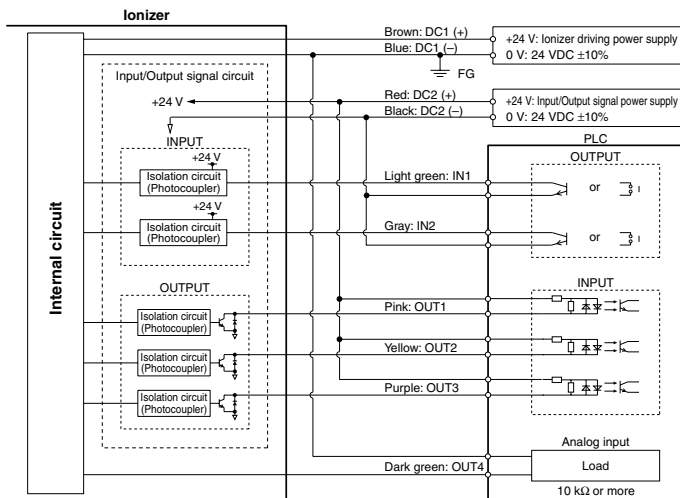

PNP output

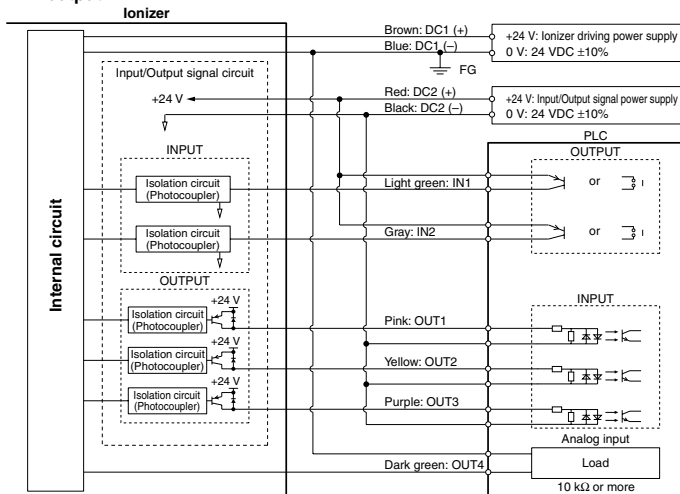

Ground the 0 V terminal of the ionizer driving power supply with a ground resistance of 100 Ω or less by connecting through the lead DC (-) [Blue] to the FG terminal. The leads for output signals (OUT1 to OUT3) are insulated from the insulation circuit (Photocoupler) while the sensor monitor output lead* (OUT4: Dark green) is not insulated from the FG terminal.

* Sensor monitor output lead (OUT4: Dark green) When the feedback sensor is used, the terminal outputs the potential measured by the feedback sensor as an analog signal. When the autobalance sensor is used, the terminal does not output signals.

The lead of the ionizer driving power supply (DC1) and the lead of the power supply for I/O signals (DC2) can be connected with a common power supply. When a common power supply is used, the lead DC1 (-) which is grounded with a ground resistance of 100 Ω or less and leads for I/O signals are not insulated.

Circuit of Power Supply Cable Connection

(2) When an autobalance sensor [body-mounting type] is used.

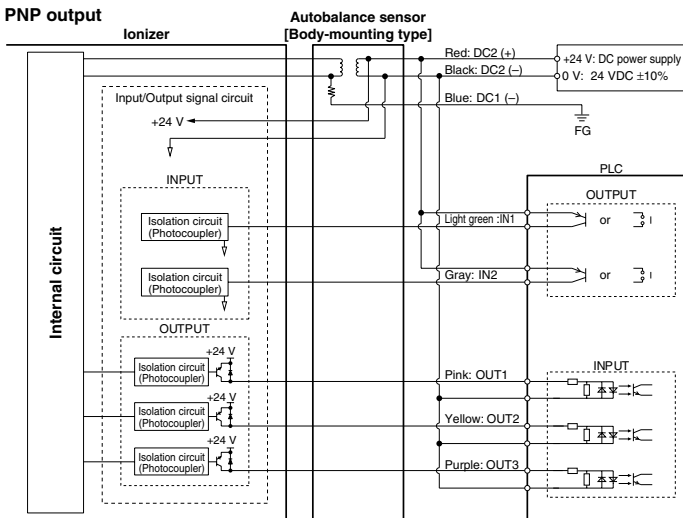
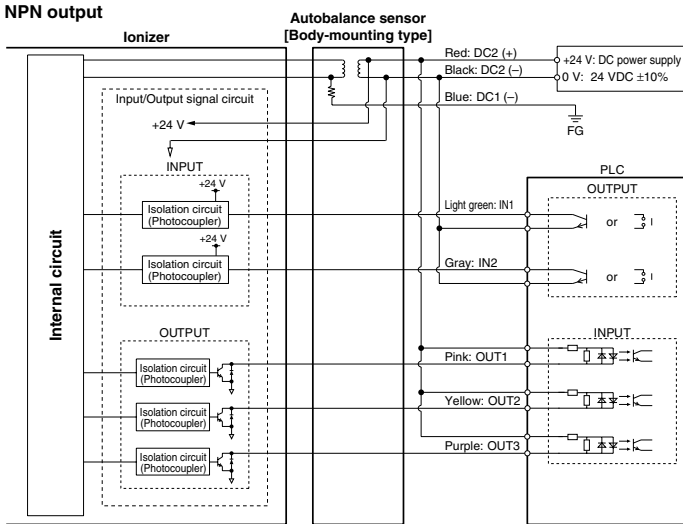

* Ground the lead DC1 (-) [Blue] with a ground resistance of 100 Ω or less without connecting to the 0 V terminal of the power supply. When the lead is connected to the 0 V terminal of the power supply and grounding is applied, leads for I/O signals are not insulated from the FG terminal.

⚠ Caution

When using the autobalance sensor (body-mounting type) near the ionizer in DC mode, keep clearance of at least 2 m between them.

* If the clearance is not enough, the ions from the ionizer in DC mode affect the control of the autobalance sensor, and the offset voltage may not be adjusted.

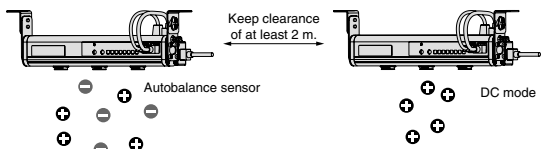

Series IZS31

Dimensions

Ionizer/IZS31-□□□□-□□

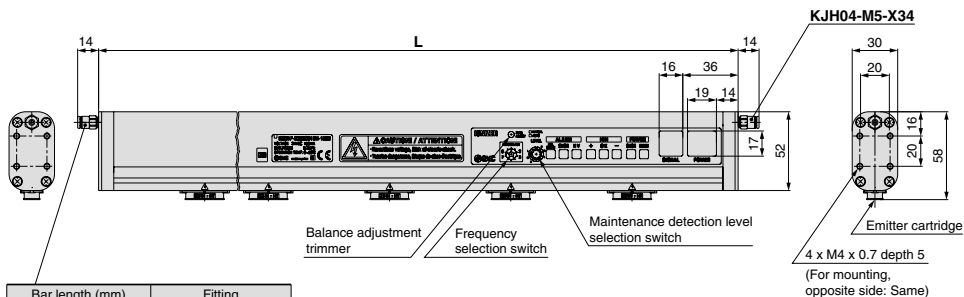

Bar length (mm)	Fitting
300, 380, 620, 780	M-5P-X112
1100, 1260, 1500, 1900, 2300	KJH04-M5-X34 (Note)

Note) Plug (M-5P-X112) 1 pc. is shipped together.

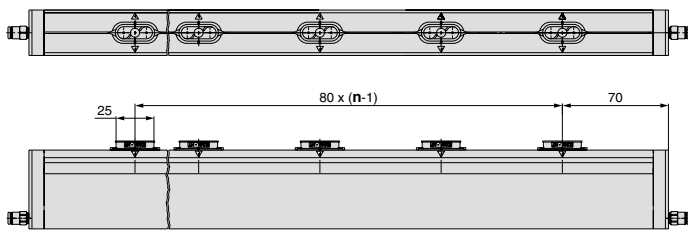
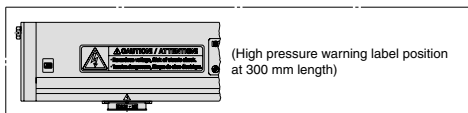

Emitter cartridge

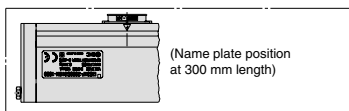

n (Number of emitter cartridges), L Dimension

Part no.	n	L(mm)
IZS31-300	3	300
IZS31-380	4	380
IZS31-620	7	620
IZS31-780	9	780
IZS31-1100	13	1100
IZS31-1260	15	1260
IZS31-1500	18	1500
IZS31-1900	23	1900
IZS31-2300	28	2300

Dimensions

End bracket/IZS31-BE

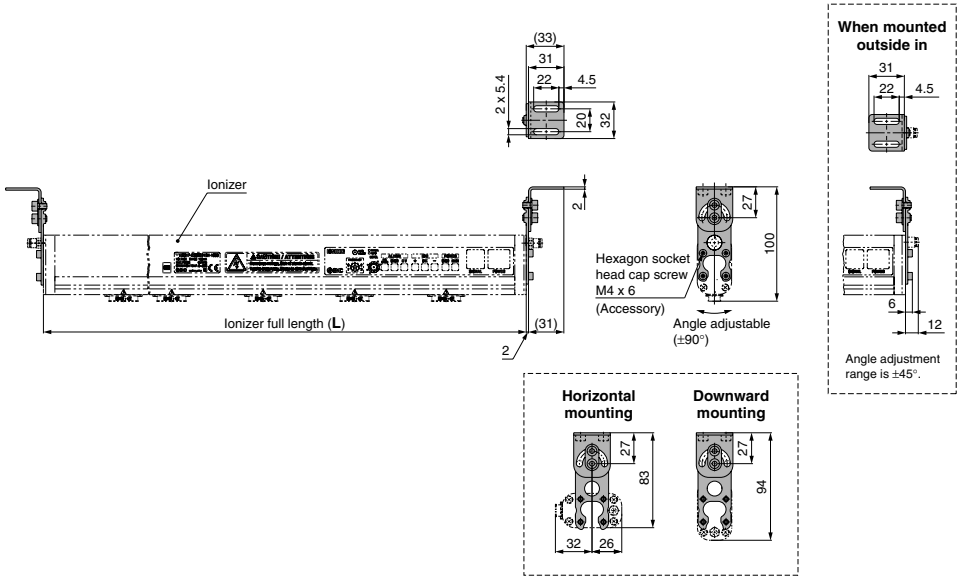

Center bracket/IZS31-BM

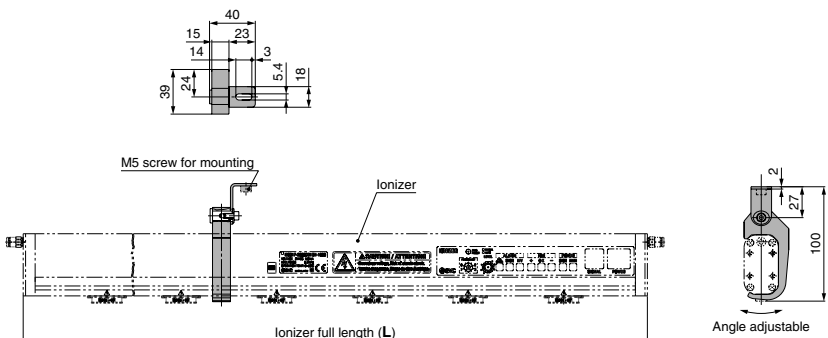

Note) Number of center brackets included in a model with brackets. (Refer to "How to Order" on page 643.)

Bar length (mm)	Center bracket
300, 380, 620, 780	None
1100, 1260, 1500	With 1 pc.
1900, 2300	With 2 pcs.

Pressure Sensor

Pressure Control

Flow Sensor

Position Detection Switch

Reduced-wiring Fieldbus System

Static Neutralization Equipment

Length Measuring/Counter

Alphabetical Index

Series IZS31

Dimensions

Feedback sensor/IZS31-DF

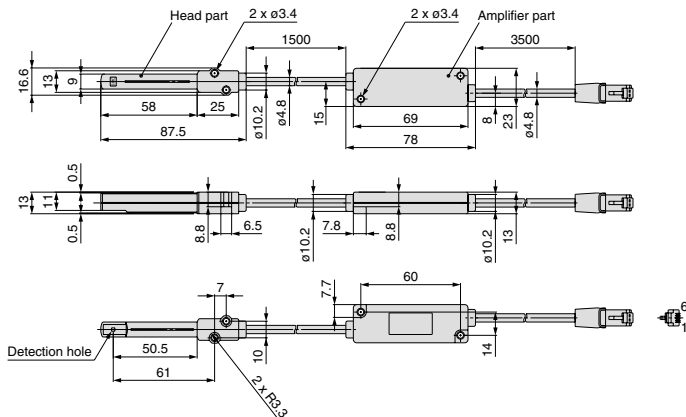

Autobalance sensor [High-precision type]/IZS31-DG

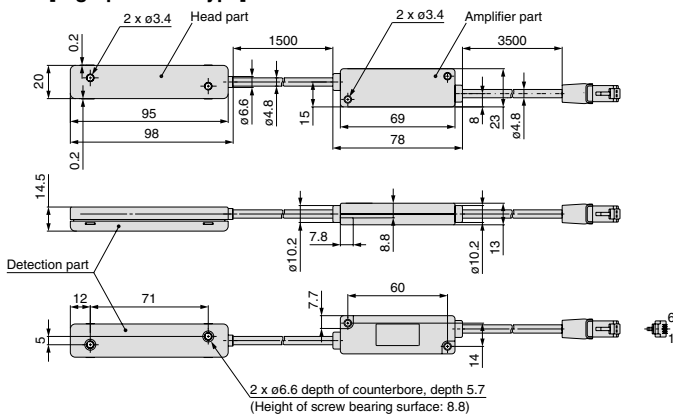

Power supply cable/IZS31-CP□

Model	L(mm)
IZS31-CP	3000
IZS31-CPZ	10000

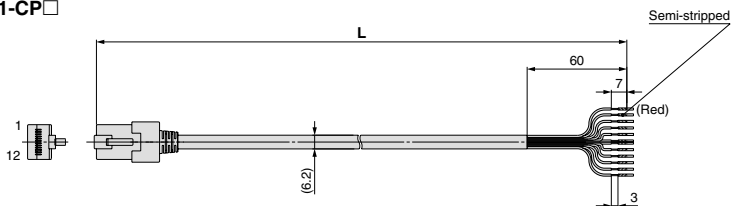

Cable Specifications

No. of cable wire	12
Nominal cross section	0.14 mm ² (AWG26)
Conductor	Outside diameter 0.48 mm
Insulator	Outside diameter 0.95 mm Brown, Blue, Green, Red, Black, Light green, Gray, White, Orange, Pink, Yellow, Purple
Material	Lead-free PVC
Sheath	Outside diameter 6.2 mm

Dimensions

Autobalance sensor [Body-mounting type]/IZS31-DE

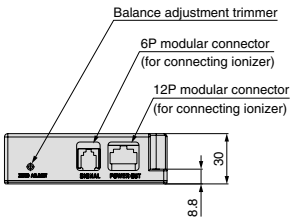
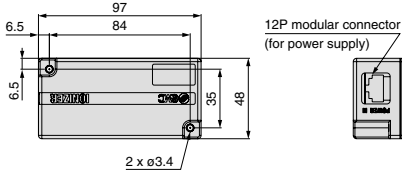

When mounting on the ionizer

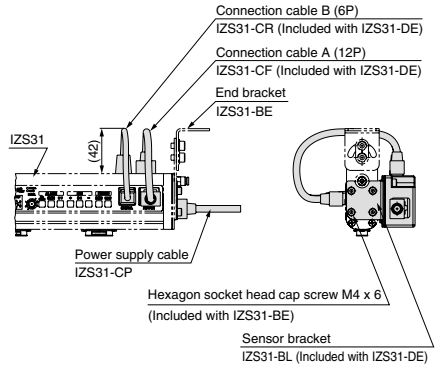
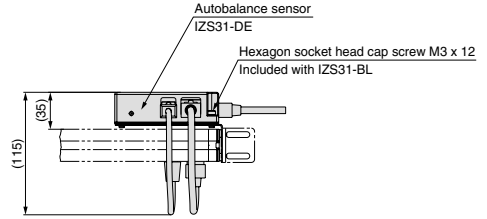

Connection cable A (12P)/IZS31-CF



Connection cable B (6P)/IZS31-CR

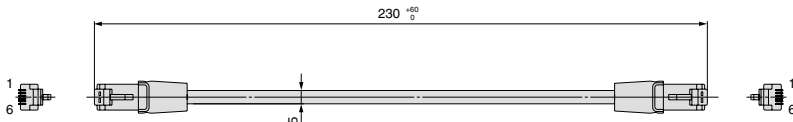

Sensor bracket/IZS31-BL

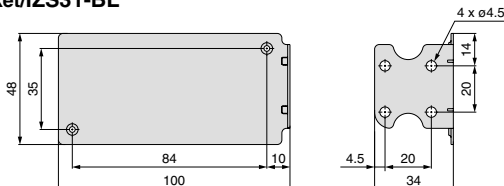

Series IZS31

Made to Order 2

Please contact SMC for detailed dimensions, specifications, and lead times.



3 Model with 40 mm-pitch emitter cartridges

Symbol
X15

Install the emitter cartridges at a 40 mm-pitch.
(Standard: 80 mm-pitch)

(Note) The maximum bar length is 1260 mm.

The air purge nozzles are arranged at an 80 mm-pitch.

- Uneven static neutralization can be prevented when the installation height is low.

Bar length (mm)	Fitting
300, 380, 620, 780	M-5P-X112
1100, 1260	KJH04-M5-X34 <small>(Note)</small>

(Note) Plug (M-5P-X112) 1 pc. is shipped together.

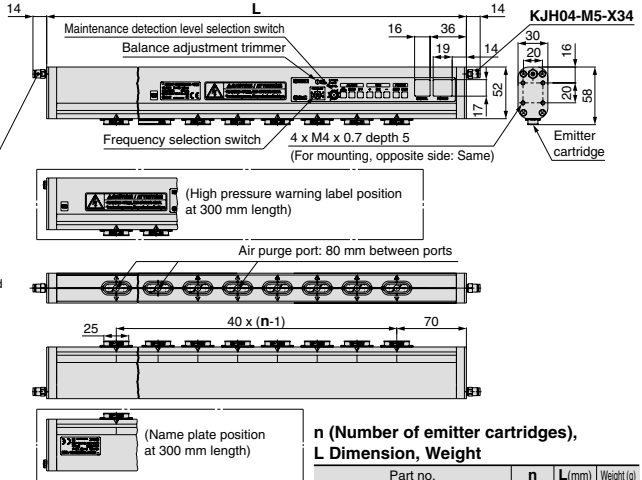

Center bracket/IZS31-BM-X158

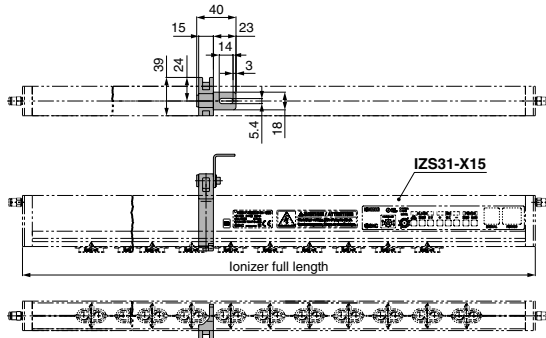

n (Number of emitter cartridges), L Dimension, Weight

Part no.	n	L(mm)	Weight(g)
IZS31-300□□□□□-X15	5	300	480
IZS31-380□□□□□-X15	7	380	540
IZS31-620□□□□□-X15	13	620	740
IZS31-780□□□□□-X15	17	780	880
IZS31-1100□□□□□-X15	25	1100	1140
IZS31-1260□□□□□-X15	29	1260	1270

(Note) Number of center brackets included in a model with brackets. (Refer to "How to Order" on page 643.)

Bar length (mm)	Center bracket
300, 380, 620, 780	None
1100, 1260	With 1 pc.

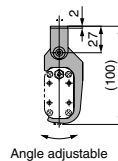

4 AC adapter (100 to 240 VAC)

Symbol
X196

Power can be directly supplied through the AC power line.
The ionizer starts operations on connecting the power supply plug to the AC power supply of 100 to 240 V.

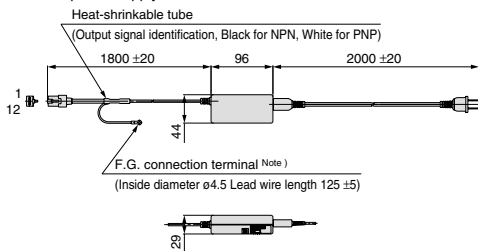

(Note) Be sure to ground the F.G. terminal with a ground resistance of 100 Ω or less.

How to Order

IZS31-F□-X196

● Applicable output specifications

NII	NPN specification
P	PNP specification

Specifications

Input voltage	100 VAC to 240 VAC, 50/60 Hz
Output voltage	24 VDC
Output current	1A
Ambient temperature	0 to 40°C
Ambient humidity	35 to 65% Rh
Weight	220 g

Pressure Sensor

Pressure Control

Flow Sensor

Position Detection Switch

Reduced-wiring Fieldbus System

Static Neutralization Equipment

Length Measuring/Counter

Alphabetical Index

Series IZS31

Made to Order 3

Please contact SMC for detailed dimensions, specifications, and lead times.



5 High-voltage/control unit detachable short type

Symbol
X210

- A short type ionizer (full length of 180 mm and 220 mm) can be installed in a small space. The high-voltage unit (ionizing unit) and control unit are detachable from each other. The distance between them is also optional according to the length of selected connection cables.

Part no.	L
IZS31-CF01-X210	1000 mm
IZS31-CF02-X210	2000 mm
IZS31-CF03-X210	3000 mm
IZS31-CF04-X210	4000 mm
IZS31-CF05-X210	5000 mm
IZS31-CF07-X210	7000 mm
IZS31-CF10-X210	10000 mm

Order connection cables separately.

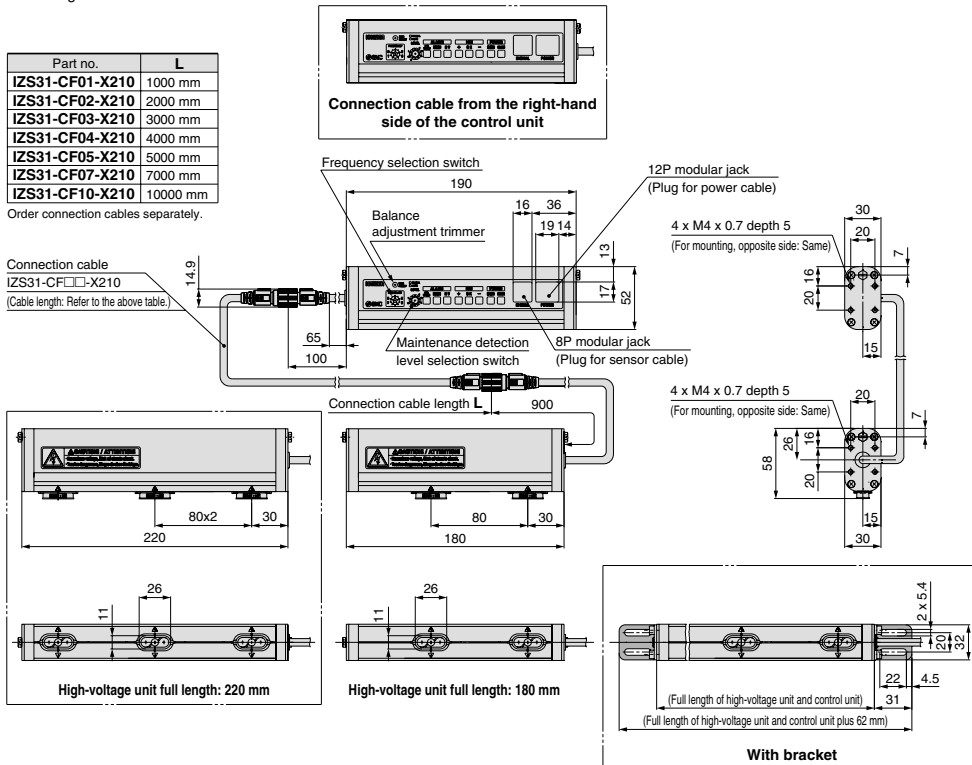

How to Order

IZS31 - 180 [] [] R [] [] - X210

High-voltage unit full length

180	180 mm
220	220 mm

Emitter material

Nil	Tungsten
C	Silicon
S	Stainless steel
J	Low-maintenance type /Tungsten
K	Low-maintenance type /Silicon

Output specification

Nil	NPN output
P	PNP output

Bracket

Nil	Without bracket
B	With bracket ^(Note)

^(Note) Four end brackets are bundled with the bracket model. Brackets can be attached on the high-voltage unit and control unit.

Power supply cable

Nil	With power supply cable (3 m)
Z	With power supply cable (10 m)
N	Without power supply cable

Control unit cable entry direction

Nil	Left-hand entry
R	Right-hand entry

Sensor

Nil	Without sensor
E	Autobalance sensor [Body-mounting type]
F	Feedback sensor
G	Autobalance sensor [High-precision type]

Series IZS31

Made to Order 4

Please contact SMC for detailed dimensions, specifications, and lead times.



6 High-voltage/control unit detachable short type with 40 mm-pitch electrode cartridges Symbol X211

- A short type ionizer (full length of 180 mm and 220 mm) can be installed in a small space. The high-voltage unit (ionizing unit) and control unit are detachable from each other. The distance between them is also optional according to the length of selected connection cables.

Model with 40 mm-pitch emitter cartridges

Part no.	L
IZS31-CF01-X210	1000 mm
IZS31-CF02-X210	2000 mm
IZS31-CF03-X210	3000 mm
IZS31-CF04-X210	4000 mm
IZS31-CF05-X210	5000 mm
IZS31-CF07-X210	7000 mm
IZS31-CF10-X210	10000 mm

Order connection cables separately.

Connection cable
IZS31-CF□□-X210
(Cable length: Refer to the above table.)

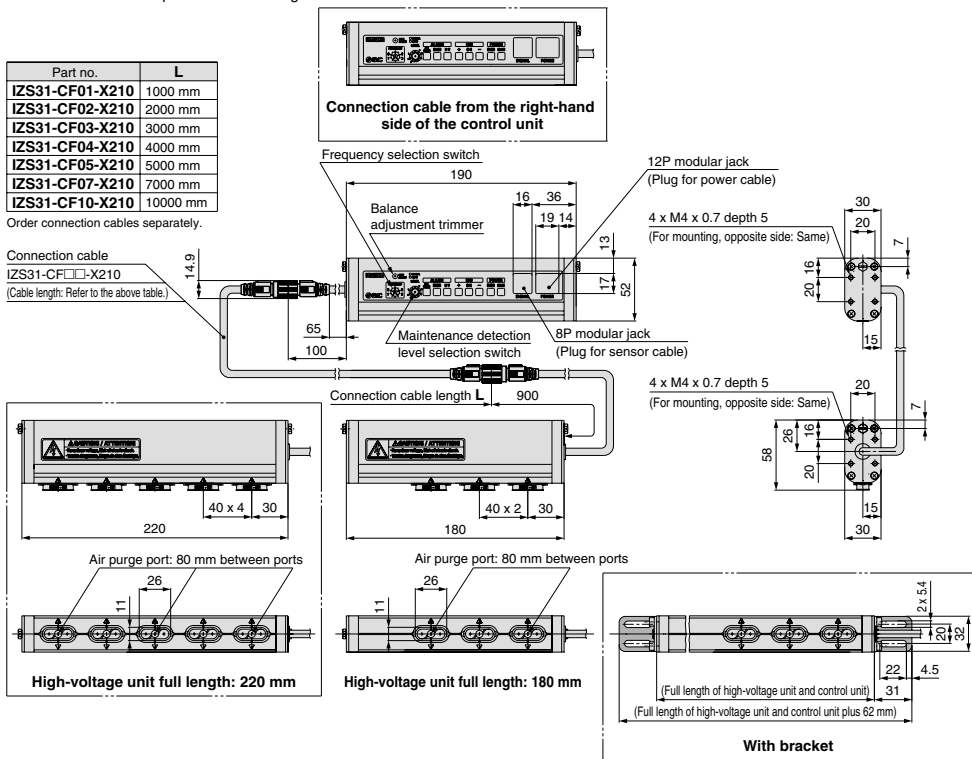

How to Order

IZS31 - 180 [] [] R [] [] - X211

High-voltage unit full length

180	180 mm
220	220 mm

Emitter material

NiI	Tungsten
C	Silicon
S	Stainless steel
J	Low-maintenance type /Tungsten
K	Low-maintenance type /Silicon

Output specification

NiI	NPN output
P	PNP output

Bracket

NiI	Without bracket
B	With bracket <small>(Note)</small>

Note) Four end brackets are bundled with the bracket model. Brackets can be attached on the high-voltage unit and control unit.

Power supply cable

NiI	With power supply cable (3 m)
Z	With power supply cable (10 m)
N	Without power supply cable

Control unit cable entry direction

NiI	Left-hand entry
R	Right-hand entry

Sensor

NiI	Without sensor
E	Autobalance sensor [Body-mounting type]
F	Feedback sensor
G	Autobalance sensor [High-precision type]

Pressure Sensor
 Pressure Control
 Flow Sensor
 Position Detection Switch
 Reduced-wiring Fieldbus System
 Static Neutralization Equipment
 Length Measuring/Counter
 Alphabetical Index



Series IZS31 Ionizers

Precautions 1

Be sure to read this before handling.

Selection

Warning

1. This product is intended to be used with general factory automation (FA) equipment.

If considering using the product for other applications (especially those stipulated in 4 on back page 1), please consult with SMC beforehand.

2. Use this product within the specified voltage and temperature range.

Using outside of the specified voltage can cause malfunction, damage, electrical shock, or fire.

3. Use clean compressed air for fluid.

This product is not explosion proof. Never use a flammable gas or an explosive gas as a fluid and never use this product in the presence of such gases. Please contact us when fluids other than compressed air are used.

4. This product is not explosion-protected.

Never use this product in locations where the explosion of dust is likely to occur or flammable or explosive gases are used. This can cause fire.

Caution

1. This product is not washed. When bringing into a clean room, flush for several minutes and confirm the required cleanliness before using.

Mounting

Warning

1. Reserve an enough space for maintenance, piping and wiring

Please take into consideration that the One-touch fittings for supplying air, need enough space for the air tubing to be easily attached/detached.

To avoid excessive stress on the connector and One-touch fitting, please take into consideration the air tubings minimum bending radius and avoid bending at acute angles.

Wiring with excessive twisting, bending, etc. can cause malfunction, wire breakage, fire or air leakage.

Minimum bending radius:

Power supply cable, connection cable A35 mm
Sensor cable, connection cable B.....25 mm

(Note: Shown above is wiring with the fixed minimum allowable bending radius and at a temperature of 20°C.

If used under this temperature, the connector can receive excessive stress even though the minimum bending radius is allowable.)

Regarding the minimum bending radius of the air tubing, refer to the instruction manual or catalog for tubing.

2. Mount this product on a plane surface.

If there are irregularities, cracks or height differences, excessive stress will be applied to the frame or case, resulting in damage or other trouble. Also, do not drop or apply a strong shock. Otherwise, damage or an accident may occur.

Mounting

Warning

3. Do not use this product in an area where noise (electric magnetic field or surge voltage, etc.) are generated.

Using the ionizer under such conditions may cause it to malfunction or internal devices to deteriorate or break down. Take noise countermeasures and prevent the lines from mixing or coming into contact with each other.

4. Observe the tightening torque requirements when mounting the ionizer. Refer to the below table for tightening torques for screws, etc.

If overtightened with a high torque, the mounting screws or mounting brackets may break. Also, if under tightened with a low torque, the connection may loosen.

Thread size	Recommended tightening torque
M3	0.61 to 0.63 N·m
M4	0.73 to 0.75 N·m
M5	1.3 to 1.5 N·m

5. Do not touch the emitter directly with fingers or metallic tools.

If a finger is used to touch the emitter, it may get stuck or an injury or electrical shock may occur from touching the surrounding equipment.

In addition, if the emitter or cartridge is damaged with a tool, the specification will not be met and damage and/or an accident may occur.

Caution High Voltage!

Emitters are under high voltage. Never touch them as there is a danger of electric shock or injury due to an evasive action against a momentary electrical shock caused by inserting foreign matter in the electrode cartridge or touching the electrode needle.

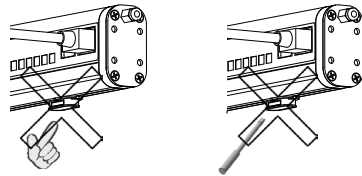

6. Do not affix any tape or seals to the body.

If a tape or seal contains any conductive adhesive or reflective paint, a dielectric phenomenon may occur due to the generated ions, resulting in electrostatic charge or electric leakage, which may cause failure of the equipment or electric shock.

7. Installation and adjustment should be conducted after turning off the power supply.



Series IZS31 Ionizers Precautions 2

Be sure to read this before handling.

Mounting

⚠ Caution

1. Install the ionizer away from a wall as illustrated below.

If a wall is located closer than the illustration below, the ions generated will not be able to reach the object which requires static neutralization and therefore result in a decrease in efficiency.

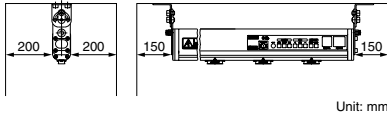

Unit: mm

After installation, be sure to verify the effects of static neutralization.

The effects vary depending on the ambient conditions, operating conditions, etc. After installation, verify the effects of static neutralization.

2. Install a feedback sensor away from the wall as illustrated below.

The ionizer may fail to measure electrostatic potentials correctly if a wall or other obstacle exists within the clearances shown in the following figure.

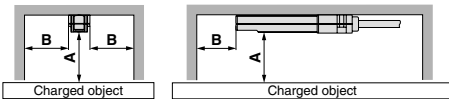

(mm)

A	B
10	20
20	40
25	45
30	55
40	65
50	75

Wiring/Piping

⚠ Warning

1. Confirm if the power supply voltage is enough and that it is within the specifications before wiring.

To maintain product performance, a DC power supply shall be connected per UL listed Class 2 certified by National Electric Code (NEC) or evaluated as a limited power source provided by UL60950.

Wiring/Piping

⚠ Warning

2. Be sure to perform wiring with a ground resistance of 100 Ω or less in order to maintain product performance.

If such wiring is not provided, not only may the offset voltage be disrupted but electric shocks may also result and the ionizer or power supply may break down.

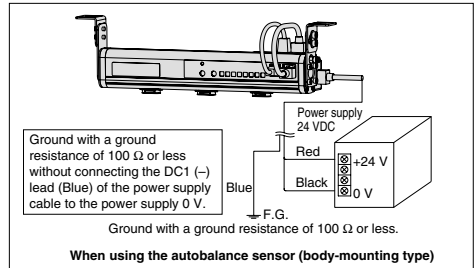
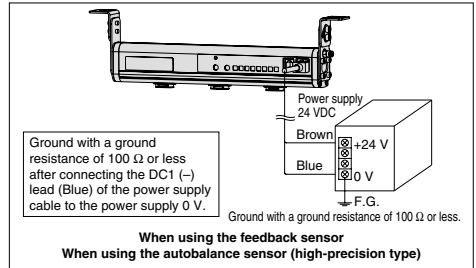

3. Be sure to turn off the power supply before wiring (including attachment/detachment of the connector).

4. To connect a feedback sensor or autobalance sensor to the ionizer, use the cable included with the sensor. Do not disassemble or modify the ionizer.

5. When applying the power supply, pay special attention to the wiring and/or surrounding environment until the safety is confirmed.
6. Do not connect or remove any connectors including the power supply, while power is being supplied. Otherwise, the ionizer may malfunction.
7. If the power line and high-pressure line are routed together, this product may malfunction due to noise. Therefore, use a separate wiring route for this product.

8. Be sure to confirm there are no wiring errors before starting this product. Incorrect wiring will lead to damage or malfunction to the product.

9. Flush the piping before using. Before piping this product, exercise caution to prevent particles, water drops, or oil contents from entering the piping.



Series IZS31 Ionizers

Precautions 3

Be sure to read this before handling.

Operating Environment/Storage Environment

Warning

1. Observe the fluid temperature and ambient temperature range.

Fluid and ambient temperature ranges are 0 to 50°C for the ionizer, feedback sensor and autobalance sensor. Do not use the ionizer in locations subject to sudden temperature changes even if the ambient temperature range is within the specified limits, as condensation may result.

2. Do not use this product in an enclosed space.

This product utilizes a corona discharge phenomenon. Do not use the product in an enclosed space as ozone and nitrogen oxides exist in such places, even though in marginal quantities.

3. Environments to avoid

Avoid using and storing this product in the following environments since they may cause damage to this product.

- Avoid using in a place that exceeds an ambient temperature range of 0 to 50°C.
- Avoid using in a place that exceeds an ambient humidity range of 35 to 80% Rh.
- Avoid using in a place where condensation occurs due to a drastic temperature change.
- Avoid using in a place in the presence of corrosive or explosive gas or where there is a volatile combustible.
- Avoid using in an atmosphere where there are particles, conductive iron powders, oil mist, salt, solvent, blown dust, cutting oil (water, liquid), etc.
- Avoid using in a place where ventilated air from an air conditioner is directly applied to the product.
- Avoid using in a closed place without ventilation.
- Avoid using in direct sunlight or radiated heat.
- Avoid using in a place where there is a strong magnetic noise (strong electric field, strong magnetic field, or surge).
- Avoid using in a place where static electricity is discharged to the body.
- Avoid using in a place where a strong high frequency occurs.
- Avoid using in a place where this product is likely to be damaged by lightning.
- Avoid using in a place where direct vibration or shock is applied to the body.
- Avoid using in a place where there is a force large enough to deform the body or weight is applied to the product.

4. Do not use an air containing mist or dust.

The air containing mist or dust will cause the performance to decrease and shorten the maintenance cycle.
Supply clean compressed air by using an air dryer (Series IDF), air filter (Series AF/AFF), and mist separator (Series AFM/AM).

5. The ionizer and sensors are not protected against a surge caused by a lightning.

6. Effects on implantable medical devices

The electromagnetic waves emitted from this product may interfere with implantable medical devices such as cardiac pacemakers and cardioverter defibrillators, resulting in the malfunction of the medical device or other adverse effects.

Please use extreme caution when operating equipment which may have an adverse effect on your implantable medical device. Be sure to thoroughly read the precautions stated in the catalog, operation manual, etc., of your implantable medical device, or contact the manufacturer directly for further details on what types of equipment need to be avoided.

Maintenance

Warning

1. Periodically (every two weeks or so) inspect the ionizer and clean the emitters.

Conduct a regular maintenance to see if the product is run having a disorder.

Maintenance should be conducted by a fully knowledgeable and experienced person about the equipment.

If particles attach to the emitter by using for long periods of time, the static neutralization performance will be lowered.

Replace the emitter, if it is worn and the static neutralization performance does not return even after being cleaned.

Caution High Voltage!

This product contains a high voltage generation circuit. When performing maintenance inspection, be sure to confirm that the power supply to the ionizer is turned off. Never disassemble or modify the ionizer, as this may not only impair the product's functionality but could cause an electric shock or electric leakage.

2. When cleaning the emitter or replacing the electrode cartridge, be sure to turn off the power supply to the body.

Touching an emitter when it is electrified may result in electric shock or other accidents.

3. Do not disassemble or modify this product.

Otherwise, an electrical shock, damage and/or a fire may occur. Also, the disassembled or modify products may not achieve the performances guaranteed in the specifications, and exercise caution because the product will not be warranted.

Handling

Warning

1. Do not drop, bump or apply excessive impact (10 G or more) while handling.

Even though it does not appear to be damaged, the internal parts may be damaged and cause malfunction.

2. When mounting/dismounting the cable, use your finger to pinch the claw of the modular plug, then attach/detach it correctly. If the modular plug is at a difficult angle to attach/detach, the modular jack's mounting section may be damaged and cause a disorder.

3. Do not operate this product with wet hands.

Otherwise, an electrical shock or accident may occur.

Related Products

SMC can provide all the equipment required to supply air to the ionizer.

Consider the equipment below not only for providing an “opportunity to decrease maintenance” and “preventing damage” but also for an “energy-saving countermeasure”.

Recommended pneumatic circuit diagram

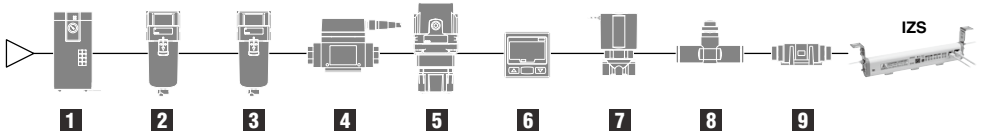

1 Air Dryer/Series IDF

Decreases the dew point of compressed air. Limits moisture generation which can lead to damage.



▶ Best Pneumatics No. ⑤

2 Air Filter/Series AF

Eliminates solid foreign matter such as powder particles in the compressed air.



▶ Best Pneumatics No. ⑤

3 Mist Separator/Series AFM

Eliminates oil mist which is difficult to eliminate with an air filter.



▶ Best Pneumatics No. ⑤

4 Digital Flow Switch/Series PF2A

Decreases the air consumption by flow control.



▶ Best Pneumatics No. ⑥

2-Color Display Digital Flow Switch/Series PFM



▶ Best Pneumatics No. ⑥

5 Regulator/Series AR

Decreases the air consumption by setting to an appropriate pressure.



▶ Best Pneumatics No. ⑤

6 Digital Pressure Switch/Series ISE30A

The pressure control prevents the ability of static electricity removal from being reduced in accordance with the reduction of air pressure.



▶ Best Pneumatics No. ⑥

7 2 Port Solenoid Valve/Series VX



▶ Best Pneumatics No. ⑦

Pilot Type 2 Port Solenoid Valve for Dry Air/Series VQ



▶ Best Pneumatics No. ⑦

8 Restrictor/Series AS-X214

Regulates to the appropriate air volume depending upon the installation condition. Decreases the air consumption.



▶ Best Pneumatics No. ⑥

9 Clean Air Filter/Series SFD

Built-in capillary element nominal filtration rating: 0.01 μm
Hollow fiber elements with over 99.99% filtering efficiency do not contaminate workpieces.



▶ Best Pneumatics No. ⑤

Pressure Sensor

Pressure Control

Flow Sensor

Position Detection Switch

Reduced-wiring Fieldbus System

Static Neutralization Equipment

Length Measuring/Counter

Alphabetical Index