

# Made to Order Common Specifications: -XC13: Auto Switch Rail Mounting Type



## 25 Auto Switch Rail Mounting Type

Symbol  
**-XC13**

A cylinder on which a rail is mounted to enable auto switches, in addition to the standard method for mounting auto switches (Band mounting type).

### Applicable Series

Series	Description	Model	Action	Note	Vol. no. (for std model)
CM2	Air cylinder	CM2-Z	Double acting, Single rod Single acting (Spring return/extend)		Web Catalog
		CM2W-Z	Double acting, Double rod		
	Non-rotating rod type	CM2K-Z	Double acting, Single rod Single acting (Spring return/extend)		
		CM2KW	Double acting, Double rod		
		Direct mount type	CM2R-Z	Double acting, Single rod	
	Non-rotating rod, Direct mount type	CM2RK-Z	Double acting, Single rod		
	Smooth cylinder	CM2Y-Z	Double acting, Single rod		
End lock cylinder	CBM2	Double acting, Single rod	For XC13A and XC13C only		
CG1	Air cylinder	CG1-Z	Double acting, Single rod	Except the trunnion type	
	Double rod type	CG1W-Z	Double acting, Double rod	Except the trunnion type	
	Non-rotating rod type	CG1K-Z	Double acting, Single rod	Except the trunnion type	
	Direct mount type	CG1R-Z	Double acting, Single rod	Except with air cushion	
	End lock cylinder	CBG1	Double acting, Single rod	For XC13A only	
MGG	Guide cylinder	MGG	Double acting		
MGC	Guide cylinder	MGC	Double acting		

### How to Order

CDM2  - XC13A

CDG1  - XC13A

\* Trunnion type of the CDG1 series cannot be mounted.

#### Rail mounting direction \*

<b>XC13A</b>	Mounted on the right side when viewed from the rod with the ports facing upwards.
<b>XC13B</b> <sup>*2, *3</sup>	Mounted on the left side when viewed from the rod.
<b>XC13C</b> <sup>*1, *2</sup>	Mounted on the underside when viewed from the rod.

- \* 1 Not available for CDG1.
- \* 2 Not available for CBG1.
- \* 3 Not available for CBM2.

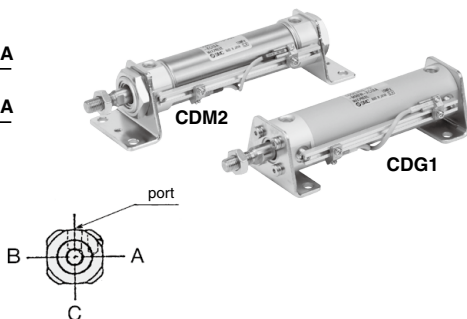

### CDM2 Applicable Auto Switches

Rail mounting type	Solid state	D-F7□, D-F7□V, D-F7BA, D-F79F, D-F79W, D-F7□WV, D-J79, D-J79C, D-J79W
	Reed	D-A9□/A9□V, D-A7/A8, D-A7□H/A80H, D-A73C/A80C, D-A79W
Auto switch specifications		For detailed specifications about an auto switch for itself, refer to pages 1289 to 1383.

### CDG1 Applicable Auto Switches

Rail mounting type	Solid state	D-M9□/M9□V, D-M9□W/M9□WV, D-M9□A/M9□AV, D-F7□, D-F7□V, D-F7BA, D-F79F, D-F79W, D-F7□WV, D-J79, D-J79C, D-J79W
	Reed	D-A7/A8, D-A7□H/A80H, D-A73C/A80C, D-A79W
Auto switch specifications		For detailed specifications about an auto switch for itself, refer to pages 1289 to 1383.

# Made to Order Common Specifications: -XC13: Auto Switch Rail Mounting Type



## 25 Auto Switch Rail Mounting Type

Symbol  
**-XC13**

### Proper Auto Switch Mounting Position (Detection at stroke end) and Mounting Height

#### CDM2 series

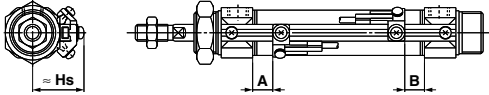

#### Proper Auto Switch Mounting Position (mm)

Auto switch model	D-F7NT		D-A9□ D-A9□V D-A79W		D-A7□ D-A80	
	A	B	A	B	A	B
D-F7□/F79F/F7□V D-J79/J79C D-F7□W/J79W/F7□WV D-F7BA/F7BAV D-A72/A7□H/A80H D-A73C/A80C	8 (5.5)	7 (4.5)	13 (10.5)	12 (9.5)	5 (2.5)	4 (1.5)
	8 (5.5)	7 (4.5)	13 (10.5)	12 (9.5)	5 (2.5)	4 (1.5)
	9 (6.5)	8 (5.5)	14 (11.5)	13 (10.5)	6 (3.5)	5 (2.5)
	15	13	19	18	12	10

#### Auto Switch Mounting Height (mm)

D-F7□/F79F D-J79/J79C D-F7□W/J79W D-F7BA D-A9□/A9□V A7□H/A80H	D-F7□V D-F7BAV	D-J79C	D-A7□ D-A80	D-A73C D-A80C	D-A79W
Hs	Hs	Hs	Hs	Hs	Hs
23.5	26	29	22.5	29.5	25
26.5	29	32	25.5	32.5	28
30	32.5	35.5	29	35	31.5
34	36.5	39.5	33	40	35.5

Note 1) ( ) : With air cushion

Note 2) Adjust the auto switch after confirming the operating conditions in the actual setting.

Note 3) For the dimensions other than the proper auto switch mounting position and its mounting height, refer to standard type for CM2 series.

#### Minimum Auto Switch Mounting Stroke (mm)

Auto switch model	No. of auto switch mounted		
	1	2 Same surface	n (n: No. of auto switches) Same surface
D-F7□V D-J79C	5	5	10 + 10 (n-2) <sup>Note</sup> (n=4, 6...)
D-F7□ D-J79	5	5	15 + 15 (n-2) <sup>Note</sup> (n=4, 6...)
D-F7□WV D-F7BAV D-A79W	10	15	10 + 15 (n-2) <sup>Note</sup> (n=4, 6...)
D-F7□W/J79W D-F7BA D-F79F/F7NT	10	15	15 + 20 (n-2) <sup>Note</sup> (n=4, 6...)
D-A9□ D-A9□V	5	10	10 + 15 (n-2) <sup>Note</sup> (n=4, 6...)
D-A7□/A80 D-A7□H/A80H D-A73C/A80C	5	10	15 + 10 (n-2) <sup>Note</sup> (n=4, 6...)
D-A7□H D-A80H	5	10	15 + 15 (n-2) <sup>Note</sup> (n=4, 6...)

Note) When "n" is an odd number, an even number that is one larger than this odd number is used for the calculation. However, the minimum even number is 4. So, 4 is used for the calculation when "n" is 1 to 3.

#### Auto Switch Mounting Bracket: Part No.

Auto switch model	Bore size (mm)
	D-A9□/A9□V

Note 1) When adding D-A9□(V), order a set of auto switch mounting brackets BQ-1 and BQ2-012 for the CDQ2 series (ø12 to ø25) separately.

When adding the auto switches other than D-A9□(V) mentioned on the left and D-F7BA(V), order auto switch mounting brackets BQ-1 separately.

Note 2) When adding the auto switch D-F7BA(V), order a stainless steel screw set BBA2 separately.

#### Operating range (mm)

Auto switch model	Bore size (mm)			
	20	25	32	40
D-F7□/F79F/F7□V D-J79/J79C D-F7□W/J79W/F7□WV D-F7BA/F7BAV D-F7NTL	3.5	3.5	4	3.5
D-A9□/D-A9□V	5.5	6	6.5	6.5
D-A7□/A80 D-A7□H/A80H D-A73C/A80C	7.5	8	8.5	8.5
D-A79W	10	10.5	12.5	12.5

\* Since the operating range is provided as a guideline including hysteresis, it cannot be guaranteed (assuming approximately ±30% dispersion). It may vary substantially depending on an ambient environment.

# Made to Order Common Specifications: -XC13: Auto Switch Rail Mounting Type



## 25 Auto Switch Rail Mounting Type

Symbol  
**-XC13**

### Proper Auto Switch Mounting Position (Detection at stroke end) and Mounting Height

#### CDG1 series

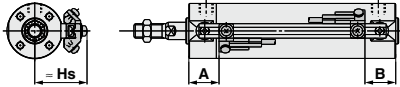

#### CDG1R series (ø20 to ø63)

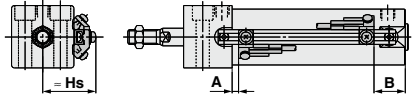

### Proper Auto Switch Mounting Position (Detection at stroke end)

#### Applicable Cylinder Series: CDG1-XC13

(mm)

Auto switch model	D-M9□/D-M9□V D-M9□W/D-M9□WV D-M9□A/D-M9□AV		D-F7□/F79F□V D-J79/J79C D-F7□W/J79W/F7□W		D-F7A/F7ABV D-A72/A7□H/A80H D-A73C/A80C		D-F7NT		D-A7□ D-A80		D-A79W	
	A	B	A	B	A	B	A	B	A	B	A	B
20	31.5	22.5 (30.5)	30.5	21.5 (29.5)	35.5	26.5 (34.5)	30	21 (29)	27.5	18.5 (26.5)		
25	31	23 (31)	30	22 (30)	35	27 (35)	29.5	21.5 (29.5)	27	19 (27)		
32	32.5	23.5 (31.5)	31.5	22.5 (30.5)	36.5	27.5 (35.5)	31	22 (30)	28.5	19.5 (27.5)		
40	37.5	25.5 (34.5)	36.5	24.5 (33.5)	41.5	29.5 (38.5)	36	24 (33)	33.5	21.5 (30.5)		
50	44.5	30.5 (42.5)	43.5	29.5 (41.5)	49	34.5 (46.5)	43	29 (41)	40.5	26.5 (38.5)		
63	43	32 (44)	42	31 (43)	47	36 (48)	41.5	30.5 (42.5)	39	28 (40)		
80	56	37 (51)	55	36 (50)	60	41 (55)	54.5	35.5 (49.5)	52	33 (47)		
100	55	38 (52)	54	37 (51)	59	42 (56)	53.5	36.5 (50.5)	51	34 (48)		

Note 1) ( ): For long stroke type

Note 2) Adjust the auto switch after confirming the operating conditions in the actual setting.

### Proper Auto Switch Mounting Position (Detection at stroke end)

#### Applicable Cylinder Series: CDG1R-XC13

(mm)

Auto switch model	D-M9□/D-M9□V D-M9□W/D-M9□WV D-M9□A/D-M9□AV		D-F7□/F79F□V D-J79/J79C D-F7□W/J79W/F7□W		D-F7A/F7ABV D-A72/A7□H/A80H D-A73C/A80C		D-F7NT		D-A7□ D-A80		D-A79W	
	A	B	A	B	A	B	A	B	A	B	A	B
20	10.5	22.5	9.5	21.5	14.5	26.5	9	21	6.5	18.5		
25	10	23	9	22	14	27	8.5	21.5	6	19		
32	11.5	23.5	10.5	22.5	15.5	27.5	10	22	7.5	19.5		
40	16.5	25.5	15.5	24.5	20.5	29.5	15	24	12.5	21.5		
50	18.5	30.5	17.5	29.5	22.5	34.5	17	29	14.5	26.5		
63	17	32	16	31	21	36	15.5	30.5	13	28		

Note) Adjust the auto switch after confirming the operating conditions in the actual setting.

### Proper Auto Switch Mounting Position/Applicable Cylinder Series: CDBG1-XC13 (mm)

Lock position	H (Head side)		R (Rod side)		W (Both sides)	
	A	B (Note 2)	A	B	A	B (Note 2)
20	+0	+12	+11	+0	+11	+12
25	+0.5	+11.5	+11.5	-0.5	+11.5	+11.5
32	+0	+10	+10	+0	+10	+10
40	+0	+14	+9	+0	+9	+14
50	+0	+17	+12	+0	+12	+17
63	+1.5	+15.5	+13.5	-1.5	+13.5	+15.5
80	-1.5	+23.5	+14.5	+1.5	+14.5	+23.5
100	-0.5	+23.5	+15.5	+0.5	+15.5	+22.5

Note 1) For end lock cylinders, add the above values to those listed in the table for CG1-XC13.

Note 2) For the head side and both sides lock, add the above values to CG1-XC13 (long stroke) to find B.

Note 3) Adjust the auto switch after confirming the operating conditions in the actual setting.

Note 4) For the dimensions other than the proper auto switch mounting position and mounting height, refer to standard type for CG1 series.

### Auto Switch Mounting Height

(mm)

Auto switch model	D-M9□/M9□V D-M9□W/M9□WV D-F7□/F79F D-J79/F7NT D-F7□W/J79W/F7□W		D-F7□V D-F7□WV D-F7BAV	D-J79C	D-A7□ D-A80	D-A73C D-A80C	D-A79W
	Hs	Hs	Hs	Hs	Hs	Hs	Hs
20	26.5	29	32	25.5	32.5	28	
25	29	31.5	34.5	28	35	30.5	
32	32.5	35	38	31.5	38.5	34	
40	36.5	39	42	35.5	42.5	38	
50	42	44.5	47.5	41	48	43.5	
63	49	51.5	54.5	48	55	50.5	
80	59	61.5	64.5	58	65	60.5	
100	69.5	72	75	68.5	75.5	71	

# Made to Order Common Specifications: -XC13: Auto Switch Rail Mounting Type



## 25 Auto Switch Rail Mounting Type

Symbol  
**-XC13**

### How to Order

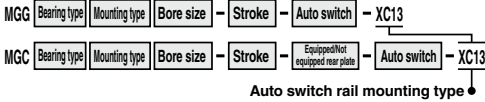

### MGG/MGC Applicable Auto Switches

Rail mounting type	Solid state switch	D-M9□/M9□V, D-M9□W/M9□WV, D-M9□A/M9□AV, D-F7□, D-F7□V, D-F7BA, D-F79F, D-F79W, D-F7□WV, D-J79, D-J79C, D-J79W
	Reed switch	D-A7/A8, D-A7□/A80H, D-A73C/A80C, D-A79W
Auto switch specifications	For detailed specifications about an auto switch for itself, refer to pages 1289 to 1383.	

### Dimensions (Dimensions other than below are the same as standard type.)

#### MGG series ø20 to ø50

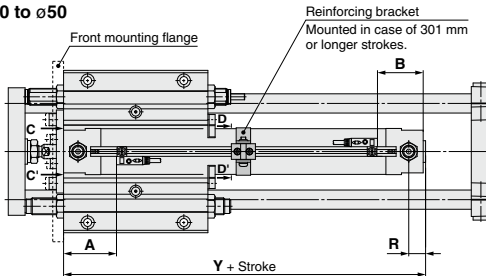

Width across flats HT



View C-C'



View D-D'

#### MGG Series (mm)

Bore size (mm)	R	Y	HS	HT	HU
20	14	99	28.5	14	30.7
25	14	99	31	14	33.2
32	14	101	34.5	14	36.5
40	15	109	39	14	41
50	16	124	49.5	17	46.2
63	16	139	56.5	17	53.2
80	23	165	75.5	23	62.2
100	23	165	86	26	72.7

#### ø63 to ø100

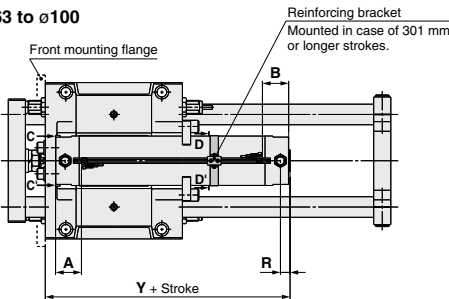

Width across flats HT



View C-C'



View D-D'

#### MGC Series (mm)

Bore size (mm)	R	Y	HS	HT	HU
20	14	99	26	7	30.7
25	14	99	28.5	7	33.2
32	14	101	34.5	14	36.5
40	15	109	39	14	41
50	16	124	49.5	17	46.2

#### MGC series ø20 to ø50

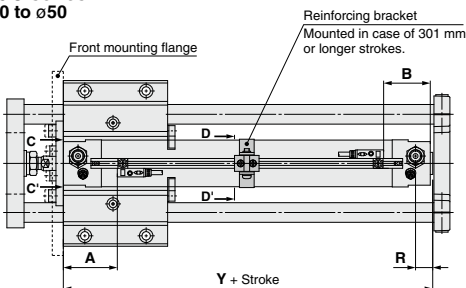

Width across flats HT



View C-C'



View D-D'

# Made to Order Common Specifications: -XC13: Auto Switch Rail Mounting Type



## 25 Auto Switch Rail Mounting Type

Symbol  
**-XC13**

### Proper Auto Switch Mounting Position (Detection at stroke end) and Mounting Height

#### Proper Auto Switch Mounting Position/Applicable Cylinder MGG, MGC Series (mm)

Auto switch model	D-M9□/M9□V D-M9□W/M9□VV D-M9□A/M9□AV		D-F7□/F79F/F7□V D-J79/J79C D-F7□W/J79W/F7□VV D-F7BA/F7BAV D-A72/A7□H/A80H D-A73C/A80C		D-F7NT		D-A7□ D-A80		D-A79W	
	A	B	A	B	A	B	A	B	A	B
	Bore size (mm)									
20	45.5	39.5	43	37	48	42	42.5	36.5	40	34
25	45.5	39.5	43	37	48	42	42.5	36.5	40	34
32	46.5	40.5	44	38	49	43	43.5	37.5	41	35
40	51.5	43.5	49	41	54	46	48.5	40.5	46	38
50	58.5	51.5	56	49	61	54	55.5	48.5	53	46
63	58.5	51.5	56	49	61	54	55.5	48.5	53	46
80	68.5	61.5	66	59	71	64	65.5	58.5	63	56
100	68.5	61.5	66	59	71	64	65.5	58.5	63	56

#### Auto Switch Mounting Height (mm)

D-M9□/M9□V D-M9□W/M9□VV D-M9□A/M9□AV		D-F7□V D-F7□VV D-F7BAV	D-J79C	D-A7□ D-A80	D-A73C D-A80C	D-A79W
Hs		Hs	Hs	Hs	Hs	Hs
26.5		29	31	26.5	32.5	30
29		31.5	33.5	29	35	32.5
32.5		34.5	36.5	32	38.5	35.5
37		39	41	36.5	43	40
42		44.5	46.5	42	48	45.5
49		51.5	53.5	49	55	52.5
58		60.5	62.5	58	64	61.5
69		71	73	68.5	74.5	72

Note 1) Adjust the auto switch after confirming the operating conditions in the actual setting.

Note 2) For dimensions other than the proper auto switch mounting position and height, refer the standard type for MGG and MGC series.

### Minimum Auto Switch Mounting Stroke/CDG1, MGG, MGC

Auto switch model	No. of auto switch mounted (mm)		
	1	2 Same surface	n (n: No. of auto switches) Same surface
D-M9□/M9□V D-F7□V D-J79C	5	5	10 + 10 (n-2) <sup>Note)</sup> (n=4, 6··)
D-M9□VV D-M9□AV D-F7□VV D-F7BAV D-A79W	10	15	10 + 15 (n-2) <sup>Note)</sup> (n=4, 6··)
D-M9□W D-M9□A	10	15	15 + 15 (n-2) <sup>Note)</sup> (n=4, 6··)
D-F7□ D-J79	5	5	15 + 15 (n-2) <sup>Note)</sup> (n=4, 6··)
D-F7□W/J79W D-F7BA D-F79F/F7NT	10	15	15 + 20 (n-2) <sup>Note)</sup> (n=4, 6··)
D-A7□/A80 D-A7□H/A80H D-A73C/A80C	5	10	15 + 10 (n-2) <sup>Note)</sup> (n=4, 6··)
D-A7□H D-A80H	5	10	15 + 15 (n-2) <sup>Note)</sup> (n=4, 6··)

Note) When "n" is an odd number, an even number that is one larger than this odd number is used for the calculation. However, the minimum even number is 4. So, 4 is used for the calculation when "n" is 1 to 3.

### Operating Range/CDG1, MGG, MGC

Auto switch model	Bore size (mm)							
	20	25	32	40	50	63	80	100
D-M9□/M9□V D-M9□W/M9□VV D-M9□A/M9□AV	4	4	5	4	5.5	6.5	7.5	7
D-F7□/F79F/F7□V D-J79/J79C D-F7□W/J79W/F7□VV D-F7BA/F7BAV D-F7NT	4.5	4	4.5	5	5	6	6	6
D-A7□/A80 D-A7□H/A80H D-A73C/A80C	9	9	10	11	11	13.5	13	13.5
D-A79W	11	11	13	14	14	16.5	16	16.5

\* Since the operating range is provided as a guideline including hysteresis, it cannot be guaranteed. (Assuming approximately ±30% dispersion.) It may vary substantially depending on an ambient environment.

### Auto Switch Mounting Bracket: Part No./CDG1, MGG, MGC

Auto switch model	Bore size (mm)	
	ø20 to ø100	
D-M9□/M9□V D-M9□W/M9□VV	BQ2-012	
D-A9□A/A9□AV	BQ2-012S	

Note 1) When adding D-M9□(V) and D-A9□W(V), order a set of auto switch mounting brackets BQ-1 and BQ2-012 for the CDQ2 series (ø12 to ø25) separately.  
When ordering the auto switches other than D-M9□□□ mentioned on the left and D-F7BA(V), order auto switch mounting brackets BQ-1 separately.

Note 2) When adding D-M9□A(V), order a stainless steel screw set BBA2 together with BQ2-012S separately.  
When adding the auto switch D-F7BA(V), order a stainless steel screw set BBA2 separately.