



ORIGINAL INSTRUCTIONS



Refer to Declaration of Conformity for relevant Directives

Instruction Manual

Actuator Position Sensor

D-MP# series



The intended use of the actuator position sensor is to monitor the position of the actuator while connected to the IO-Link communication protocol.

1 Safety Instructions

These safety instructions are intended to prevent hazardous situations and/or equipment damage. These instructions indicate the level of potential hazard with the labels of "Caution," "Warning" or "Danger." They are all important notes for safety and must be followed in addition to International Standards (ISO/IEC^{*)}, and other safety regulations.

^{*)} ISO 4414: Pneumatic fluid power - General rules relating to systems.
ISO 4413: Hydraulic fluid power - General rules relating to systems.
IEC 60204-1: Safety of machinery - Electrical equipment of machines. (Part 1: General requirements)
ISO 10218-1: Manipulating industrial robots - Safety, etc.

- Refer to product catalogue, Operation Manual and Handling Precautions for SMC Products for additional information.
- Keep this manual in a safe place for future reference.
- This product is class A equipment intended for use in an industrial environment. There may be potential difficulties in ensuring electromagnetic compatibility in other environments due to conducted or radiated disturbances.

Caution	Caution indicates a hazard with a low level of risk which, if not avoided, could result in minor or moderate injury.
Warning	Warning indicates a hazard with a medium level of risk which, if not avoided, could result in death or serious injury.
Danger	Danger indicates a hazard with a high level of risk which, if not avoided, will result in death or serious injury.

Warning

- Always ensure compliance with relevant safety laws and standards.**
- All work must be carried out in a safe manner by a qualified person in compliance with applicable national regulations.
- Do not disassemble, modify (including changing the printed circuit board) or repair.**
An injury or failure can result.
- Do not operate the product outside of the specifications.**
Fire, malfunction or damage to the product can result.
- Do not operate in an atmosphere containing flammable, explosive or corrosive gas.**
Fire or an explosion can result.
- Do not use the product for flammable or harmful fluids.**
Fire, explosion, damage or corrosion can result.
- If using the product in an interlocking circuit:**
Provide a double interlocking system, for example a mechanical system.
- Check the product for correct operation.**
Otherwise malfunction can result, causing an accident.
- Do not use the product in a place where static electricity is a problem.**
Product failure or system malfunction may result.
Otherwise electric shock, malfunction or product damage can result.
- Refer to the operation manual on the SMC website (URL: <https://www.smcworld.com>) for more safety instructions.

2 Specifications

2.1 General specifications

Model	D-MP 025*	D-MP 050*	D-MP 100*	D-MP 200*
Length determination range	25 mm ±1 mm	50 mm ±1 mm	100 mm ±1 mm	200 mm ±1 mm
Power supply voltage	15 to 30 VDC, ripple (p-p) 10% or below (with power supply polarity protection)			
Current consumption	48 mA or less (when no load is applied)			
Repeatability	0.1 mm (@25 °C)			
Resolution	0.05 mm			
Linearity	±0.3 mm (@25 °C)			
Switch output	NPN or PNP 1 output (push-pull)			
Max. load current	40 mA			
Internal voltage drop	2 V or less			
Leakage current	NPN: 0.5 mA or less at load resistance 3 kΩ, 1.5 mA or less at load resistance 750 Ω			
	PNP: 0.1 mA or less			
Short circuit protection	Yes			
Analogue current output	Output current	4 to 20 mA		
	Max. load resistance	500 Ω		
Analogue voltage output	Output voltage	0 to 10 V		
	Min. load resistance	2 kΩ		
Lead wire	PUR 4 core φ2.6 0.08 mm ²			
Standards	CE marked (EMC and RoHS Directive), UL			
Impact resistance	300 m/s ²			
Insulation resistance	50 MΩ or more with 500 VDC Ohmmeter			
Withstand voltage	1000 VAC 1 minute			
Ambient temperature	-10 to 60 °C			
Enclosure rating	IEC60529 IP67			

2.2 IO-Link specifications

Model	D-MP 025*	D-MP 050*	D-MP 100*	D-MP 200*
IO-Link type	Device			
IO-Link version	V1.1			
SIO mode	Available			
Communication speed	COM3 (230.4 kbps)			
Minimum cycle time	1 ms			
Process data length	Input: 2 bytes, Output: 0 bytes			
Device ID	125 hex	126 hex	127 hex	128 hex
Vendor ID	83 hex			

3 Names of Individual parts

3.1 D-MP#

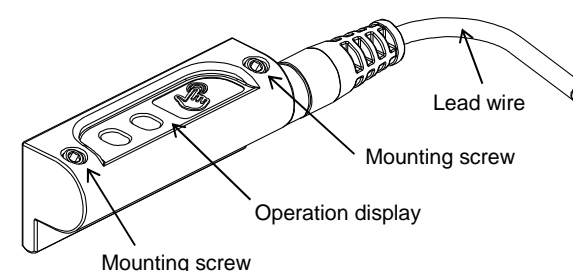

3.2 Operation Display

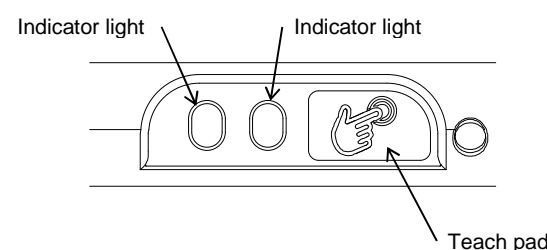

Operation Light Colours

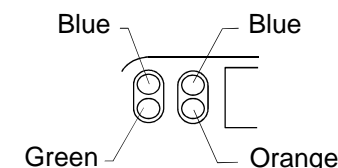

Category	Mode	Indicator light 2	Indicator light 1	Description
System status	Analogue Current output	B	●	Analogue current output active
	Analogue Voltage output	G	●	Analogue voltage output active
	IO-Link	G	●	IO-Link connection active
Switch output	Error		○	Sensor not ready for operation / Detectable magnetic field is decrease. LED flashing at 4 Hz
	High		B	Switch output High PNP: ON, NPN: OFF
	Low		B	Switch output Low PNP: OFF, NPN: ON
Magnetic field	Over current error		B	Overload of the switch output (over current) LED flashing.
	In measuring range		○	Magnetic field registered in measuring range
	Outside of measuring range		○	Magnetic field is not registered in measurement range

● = LED ON, ○ = LED flashing, ○ = LED OFF
B = Blue, O = Orange, G = Green

4 Installation

4.1 Installation

Warning

- Do not install the product unless the safety instructions have been read and understood.
- Use the product within the specified operating pressure and temperature range.
- When mounting an actuator position sensor, use a mounting bracket appropriate for the cylinder/actuator.
- The mounting method differs according to the type of actuator and the inner diameter of the tube.
- When mounting a sensor for the first time, check that the cylinder/actuator has a built-in magnet and use an appropriate bracket for the cylinder/actuator. There are also cases when a bracket is not needed.
- Use the correct tightening torque
When tightening mounting screws, use a suitable hexagon wrench (size 1.5). Recommended torque should be 0.2 to 0.4 Nm. Over-tightening can damage the cylinder/actuator and sensor. Loose screws can cause misalignment or a reduction in accuracy during operation. Tightening below the specified tightening torque will allow the position sensor to move out of position.
- Do not carry an actuator by the position sensor lead wire.
- This may cause a broken lead wires or damage to the auto switch internal elements.
- Use only the screws installed in the position sensor body for mounting the position sensor.
If other screws are used, the position sensor may be damaged.
- Check and adjust the actual product operation during installation.
The auto switch may not operate in the correct actuator mounting position due to the installation environment. Also check and adjust the auto switch operation when used in intermediate stroke positions, according to the operating environment.
- Press the switch down into the cylinder/actuator switch mounting groove as shown.

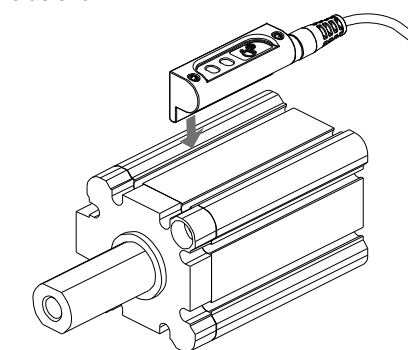

- Tighten the mounting screws evenly.

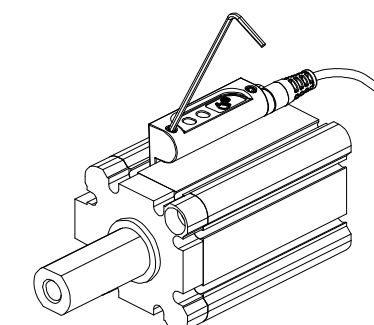

4.2 Environment

Warning

- Do not use in an environment where corrosive gases, condensation, chemicals, salt water or steam are present.
- Do not use in an explosive atmosphere.
- Do not expose to direct sunlight. Use a suitable protective cover.
- Do not install in a location subject to vibration or impact in excess of the product's specifications.
- Do not mount in a location exposed to radiant heat that would result in temperatures in excess of the product's specifications.
- Do not use in a location where magnetic fields are generated.

4 Installation (continued)

4.3 Wiring

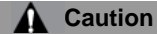

Caution

- Do not perform wiring while the power is on.
- Confirm proper insulation of wiring. Check that there is no faulty wiring insulation (short circuits, faulty ground connections, improper insulation between terminals, etc.), as this may damage the auto switch due to over current.
- Do not route the auto switch wiring in the same place as power cables or high voltage cables. Otherwise auto switch malfunction may result due to noise and inrush current.
- Avoid repeatedly bending or stretching the lead wire. Broken lead wires will result if bending stresses or tensile forces are applied to the lead wires. Stress and tensile forces applied to the connection between the lead wire and the product increases the possibility of disconnection. Secure the lead wire to reduce any movement in the area where the lead wire connects with the position sensor.
- Do not allow short-circuit of loads. There is a risk of damage of position sensor.
- Keep wiring as short as possible to prevent interference from electromagnetic noise and surge voltage. Do not use a cable longer than 20 m.

4.4 Wiring Diagram

SIO mode - NPN output

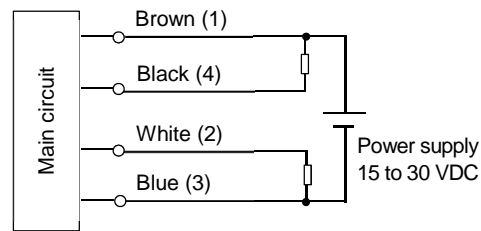

SIO mode - PNP output

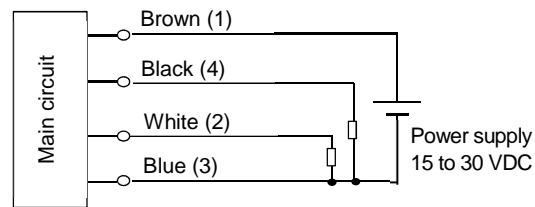

IO-Link mode

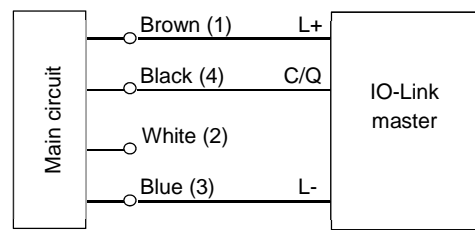

- Analogue output (white) is disabled when IO-Link mode is selected.

4.5 Connector pin layout

Pin number	Wire colour	Description
1	Brown	Power supply DC (+)
2	White	Analogue current / voltage output
3	Blue	Power supply DC (-)
4	Black	IO-Link / Switch output (C/Q)

5 Setting

5.1 Initial settings

Switch output: Low (NPN = ON, PNP = OFF),
Analogue output: Current output, Range: Full range

Teach pad setting procedure

NOTE: For teaching the measurement range, make sure that the piston position is at the start point of the range.

Click the teach pad, and then click and hold down the teach pad.

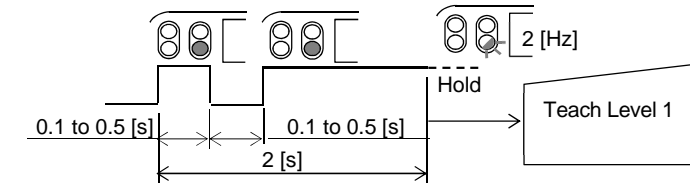

Teach Level 1 starts when the indicator LED flashes slowly.

NOTE: If the indicator LED does not flash and setting is not available, wait for 3 seconds and double-click the teach pad again.

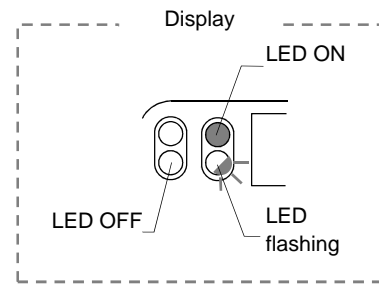

5.2 Teach Level 1

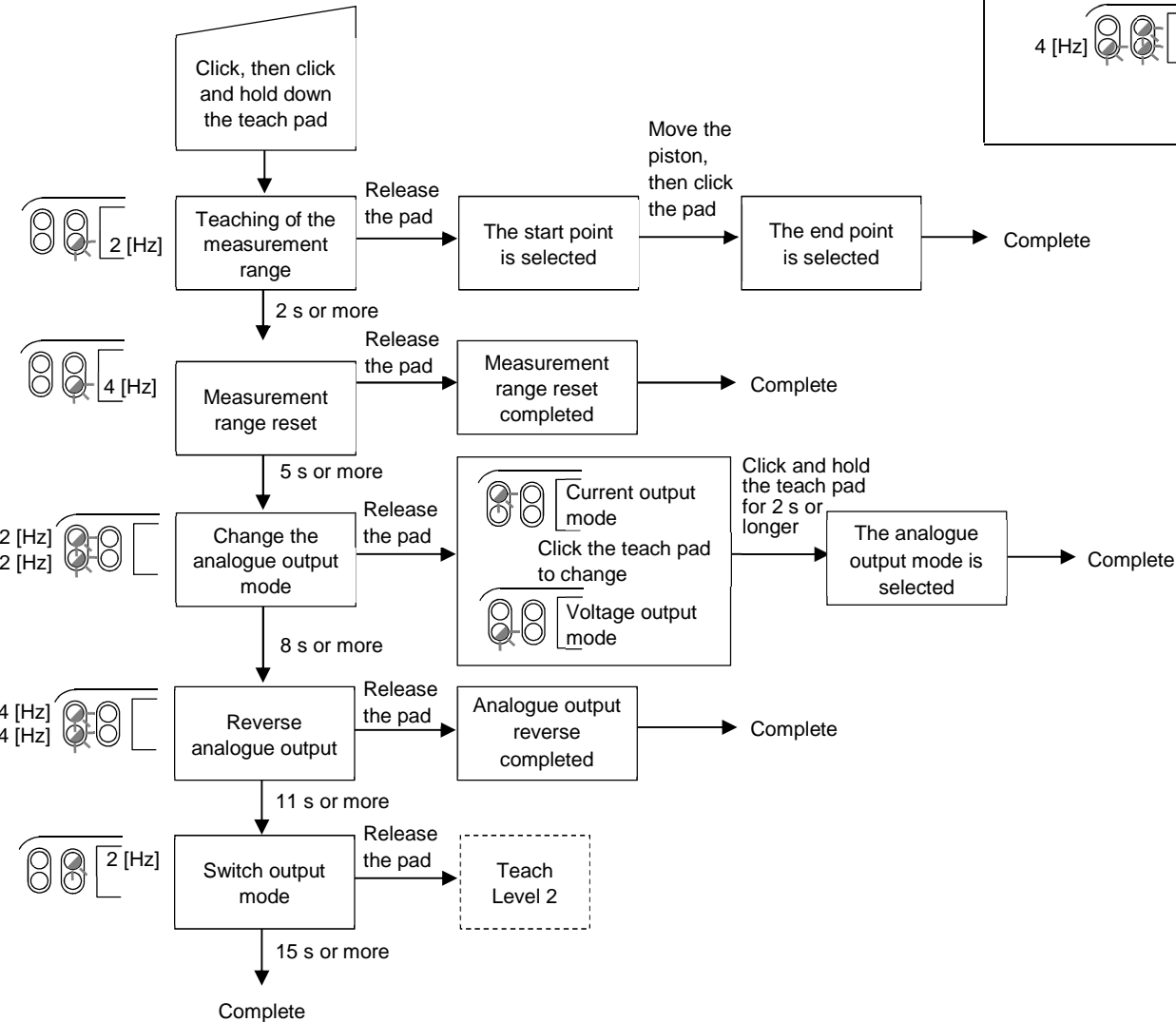

5.3 Teach Level 2

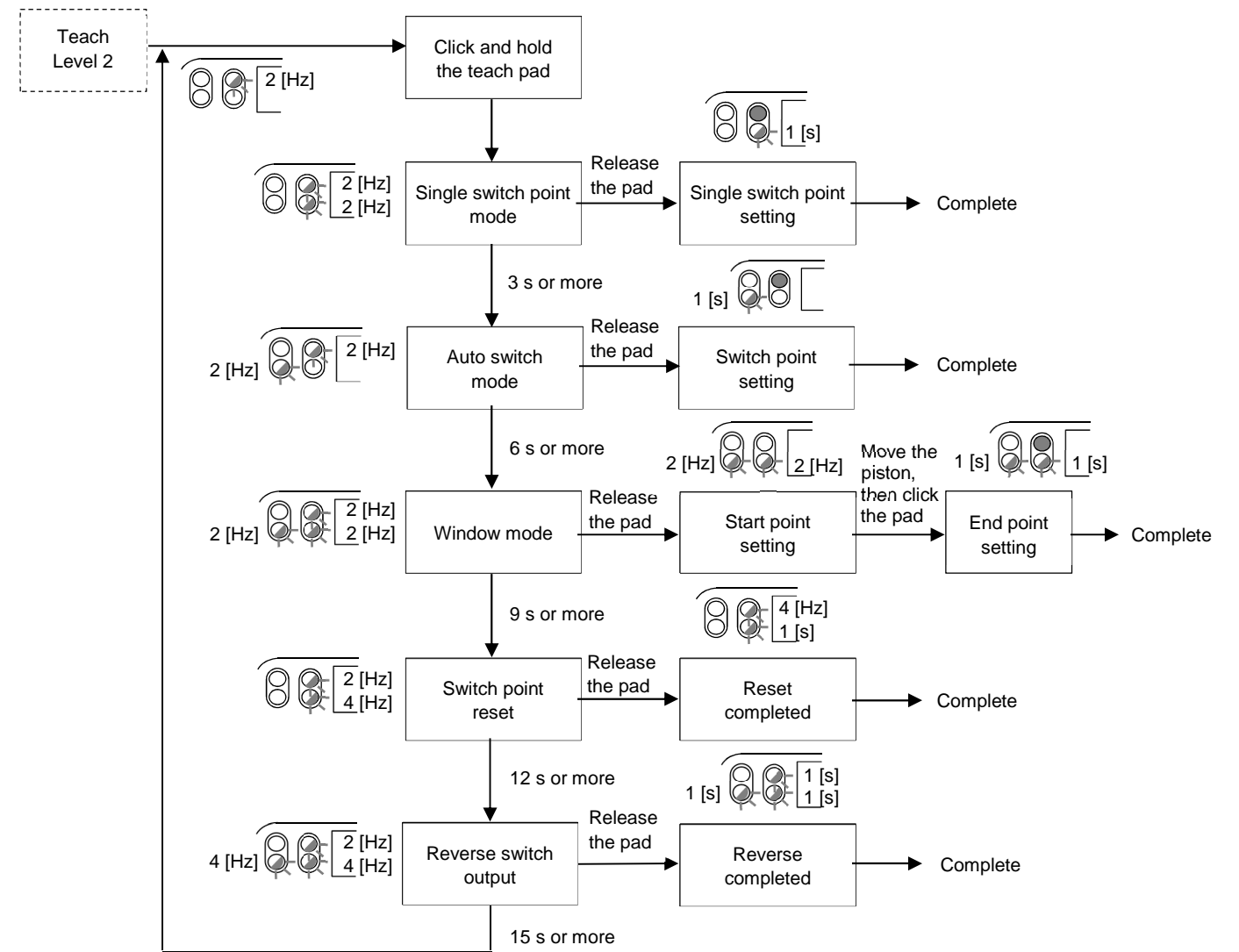

5.4 Setting completed

When a magnet (subject to be detected) is present outside of the measurement range, the indicator LED flashes 4 times and setting is complete.

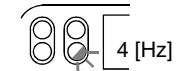

5.5 IO-Link parameter settings

• IODD file
IODD (I/O Device Description) is a definition file which provides all properties and parameters required for establishing functions and communication of the device. IODD includes the main IODD file and a set of image files such as vendor logo, device picture and device icon. The IODD file is shown below.

	Product No.	IODD file *
1	D-MP025A/B/C	SMC-D-MP025-yyyyymmdd-IODD1.1
2	D-MP050A/B/C	SMC-D-MP050-yyyyymmdd-IODD1.1
3	D-MP100A/B/C	SMC-D-MP100-yyyyymmdd-IODD1.1
4	D-MP200A/B/C	SMC-D-MP200-yyyyymmdd-IODD1.1

*: "yyyyymmdd" indicates the file preparation date. yyyy year, mm month and dd day.

The IODD file can be downloaded from the SMC website (URL: <https://www.smcworld.com>)

6 Maintenance

6.1 General Maintenance

⚠ Caution

- Not following proper maintenance procedures could cause the product to malfunction and lead to equipment damage.
- If handled improperly, compressed air can be dangerous.
- Maintenance of pneumatic systems should be performed only by qualified personnel.
- Before performing maintenance, turn off the power supply and be sure to cut off the supply pressure. Confirm that the air is released to atmosphere.
- After installation and maintenance, apply operating pressure and power to the equipment and perform appropriate functional and leakage tests to make sure the equipment is installed correctly.
- If any electrical connections are disturbed during maintenance, ensure they are reconnected correctly and safety checks are carried out as required to ensure continued compliance with applicable national regulations.
- Do not make any modification to the product.
- Do not disassemble the product, unless required by installation or maintenance instructions.
- (1) Removal of equipment, and exhausting the compressed air.
- When components are removed, first confirm that measures are in place to prevent workpiece from dropping, run-away equipment, etc. Then, cut the supply pressure and electric power, and exhaust all compressed air from the system using the residual pressure release function.
- When machinery is restarted, proceed with caution after confirming that appropriate measures are in place to prevent cylinders from sudden movement.
- Perform the following maintenance regularly to avoid possible danger due to unexpected position sensor malfunction.
 - 1) Securely tighten the position sensor mounting screws.
If screws become loose or the mounting, position is moved, retighten them after adjusting the mounting position.
 - 2) Check that there is no damage to the lead wire.
If damage to the lead wire is found, replace the position sensor, or repair the lead wire, to avoid faulty insulation.
- Do not use solvents such as benzene, thinner, alcohol etc. to clean the position sensor.
These can damage the surface of the body and erase the markings on the body.
For heavy stains, use a damp cloth that has been soaked with diluted neutral detergent and fully squeezed, then wipe up the stains again with a dry cloth.
- **How to reset the product after a power cut or when the power has been unexpectedly removed**
Regarding set up, contents of the program may be maintained by customer's application systems.
Be sure to confirm safety when returning operation of the cylinder and actuator because it could have been stopped in an unstable condition.

7 How to Order

Refer to drawings/catalogue for 'How to Order' information.

8 Outline Dimensions (mm)

Refer to the operation manual on the SMC website (URL: <https://www.smcworld.com>) for outline dimensions.

9 Troubleshooting

Refer to the operation manual on the SMC website (URL: <https://www.smcworld.com>) for detailed information about troubleshooting.

When any position sensor failure occurs, perform the trouble shooting described in the operation manual.

A failure of the position sensor might depend on the operating environment (application etc.) and may need to be tested separately by contacting SMC.

10 Limitations of Use

10.1 Limited warranty and Disclaimer/Compliance Requirements

Refer to Handling Precautions for SMC Products.

11 Contacts

Refer to Declaration of Conformity and URL: <https://www.smcworld.com> for contacts.

SMC Corporation

URL : <https://www.smcworld.com> (Global) <https://www.smceu.com> (Europe)
 'SMC Corporation, Akihabara UDX15F, 4-14-1, Sotokanda, Chiyoda-ku, Tokyo 101 0021
 Specifications are subject to change without prior notice from the manufacturer.
 © 2019 SMC Corporation All Rights Reserved.
 Template DKP50047-F-085H