

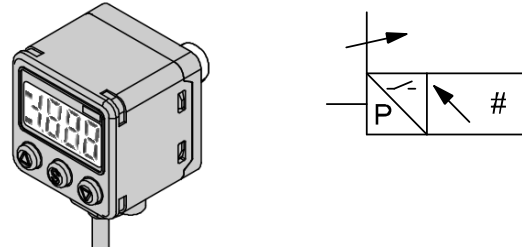

ORIGINAL INSTRUCTIONS

**Instruction Manual**  
**Digital Pressure Switch**  
**Series ZSE40A(F) / ISE40A**



The intended use of this digital pressure switch is to measure, monitor and display pressure and to provide an output signal.

**1 Safety Instructions**

These safety instructions are intended to prevent hazardous situations and/or equipment damage. These instructions indicate the level of potential hazard with the labels of "Caution," "Warning" or "Danger." They are all important notes for safety and must be followed in addition to International Standards (ISO/IEC<sup>1)</sup>, and other safety regulations.

<sup>1)</sup> ISO 4414: Pneumatic fluid power - General rules relating to systems.  
ISO 4413: Hydraulic fluid power - General rules relating to systems.  
IEC 60204-1: Safety of machinery - Electrical equipment of machines. (Part 1: General requirements)  
ISO 10218-1: Robots and robotic devices - Safety requirements for industrial robots - Part 1: Robots.

- Refer to product catalogue, Operation Manual and Handling Precautions for SMC Products for additional information.
- Keep this manual in a safe place for future reference.

<b>Caution</b>	Caution indicates a hazard with a low level of risk which, if not avoided, could result in minor or moderate injury.
<b>Warning</b>	Warning indicates a hazard with a medium level of risk which, if not avoided, could result in death or serious injury.
<b>Danger</b>	Danger indicates a hazard with a high level of risk which, if not avoided, will result in death or serious injury.

**Warning**

- **Always ensure compliance with relevant safety laws and standards.**
- All work must be carried out in a safe manner by a qualified person in compliance with applicable national regulations.
- This product is class A equipment intended for use in an industrial environment. There may be potential difficulties in ensuring electromagnetic compatibility in other environments due to conducted or radiated disturbances.  
Otherwise electric shock, malfunction or product damage can result.
- Refer to the operation manual on the SMC website (URL: <https://www.smcworld.com>) for more safety instructions.
- Special products (-X) might have specifications different from those shown in the specifications section. Contact SMC for specific drawings.

**2 Specifications**

**2.1 General specifications**

Model No.	ZSE40A (vacuum)	ZSE40AF (compound)	ISE40A (positive)	
Rated pressure range	0 to -101.3 kPa	-100.0 to 100.0 kPa	-0.100 to 1.000 MPa	
Set pressure range	10.0 to -105.0 kPa	-105.0 to 105.0 kPa	-0.105 to 1.050 MPa	
Withstand pressure	500 kPa	500 kPa	1.5 MPa	
Minimum display unit	0.1 kPa	0.1 kPa	0.001 MPa	
Applicable fluid	Air, inert gases and incombustible gases			
Power supply voltage	12 to 24 VDC ±10%, ripple (p-p) 10% or less (protected against reverse connection)			
Current consumption	45 mA or less			
Switch output	NPN or PNP open collector 2 outputs			
Max. load current	80 mA			
Max. applied voltage	28 V (NPN output)			
Residual voltage	1 V or less (at 80 mA load current)			
Response time	2.5 ms or less (with anti-chatter function: 20, 100, 500, 1000 or 2000 ms)			
Protection	Short circuit protection			
Repeatability	±0.2% F.S. ±1 digit			
Hysteresis	0 to variable			
Analogue output	Voltage	Output voltage (rated pressure)	1 to 5 V ±2.5% F.S. / 0.6 to 5 V ±2.5% F.S.	
		Linearity	±1% F.S.	
	Current	Output impedance	Approx. 1 kΩ	
		Output current (rated pressure)	4 to 20 mA ±2.5% F.S.	2.4 to 20 mA ±2.5% F.S.
Load impedance	Max. load impedance: 300 Ω (at 12 VDC) / 600 Ω (at 24 VDC)			
	Min. load impedance: 50 Ω			
Auto-shift input	Non-voltage input (reed or solid state), Low level 0.4 V or less, input time 5 ms min.			
Display	3½ digits, 7-segment, dual-colour display (red/green)			
Display accuracy	±2% F.S. ±1 digit (at 25 ±3 °C)			
Indicator LED	LED is ON when output is ON OUT: Orange			
Environment	Enclosure	IP65		
	Operating temperature range	Operation: -5 to 50 °C, Storage: -10 to 60 °C (no condensation or freezing)		
	Operating humidity range	Operation, Storage: 35 to 85% RH (no condensation)		
	Withstand voltage	1000 VAC, 1 minute between terminals and housing		
Insulation resistance	50 MΩ or more at 500 VDC between terminals and housing			
UL Temperature rating	Surrounding air temperature rating: Maximum 50 °C			
Temperature characteristics	±2% F.S. (at 25 °C reference)			
Lead wire	Oil resistant vinyl cabtyre cable 5 cores φ3.5, 2 m Conductor: 0.15 mm <sup>2</sup> (AWG26) O.D. of insulator: 0.95 mm			

**2.2 Piping / Weight specifications**

Model No.	01	N01	W1	WF1	M5	C4	C6
Port size	R1/8 (M5 female)	NPT1/8 (M5 female)	Rc1/8	G1/8	M5 female	One-touch fitting φ4	One-touch fitting φ6
Material	Sensor	Silicone					
	Piping port	C3602 (electroless nickel plating) O-ring: HNBR			ZDC2 O-ring: HNBR	ZDC2, POM, SUS304, C3604 (electroless nickel plating) O-ring: HNBR, NBR	
Weight	78 g	79 g	97 g	97 g	104 g	101 g	101 g

**3 Name and function of parts**

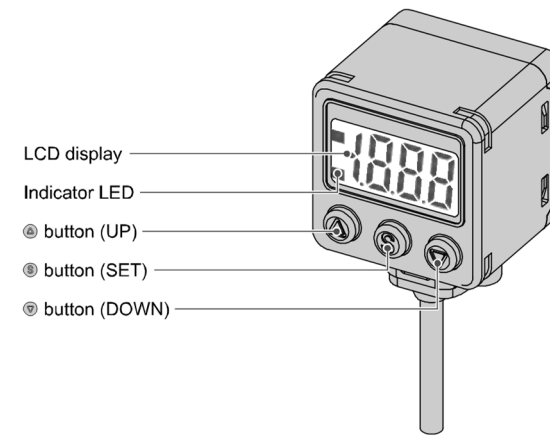

Indicator LED (Orange LED): Displays the switch output condition.  
LCD display: Displays the current status of pressure, setting mode and error code.  
Four display modes can be selected: display always in red or green, or display changing from green to red, or red to green, according to the output status.

- Ⓐ button (UP): Selects the mode or increases the ON/OFF set value. Press this button to change to the peak display mode.
- Ⓧ button (DOWN): Selects the mode or decreases the ON/OFF set value. Press this button to change to the bottom display mode.
- Ⓢ button (SET): Press this button to change to another mode and to set a value.

**4 Installation**

**4.1 Installation**

**Warning**

- Do not install the product unless the safety instructions have been read and understood.
- When the product is to be mounted in a place where water and dust splashes occur, insert a tube (O.D φ4 mm, I.D φ2.5 mm) into the atmospheric vent port of the product.

**4.1.1 Mounting with bracket**

- Mount the bracket to the product with the mounting screws M3 x 5 L (2 pcs.) or M4 x 5 L (2 pcs.) supplied, then set the product in the required position.

\*: The required tightening torque is 0.5 to 0.7 N•m for the M3 set screws and 1.4 to 1.6 N•m for the M4 set screws.

**Bracket A or D (Part No.: ZS-24-A / ZS-24-D)**

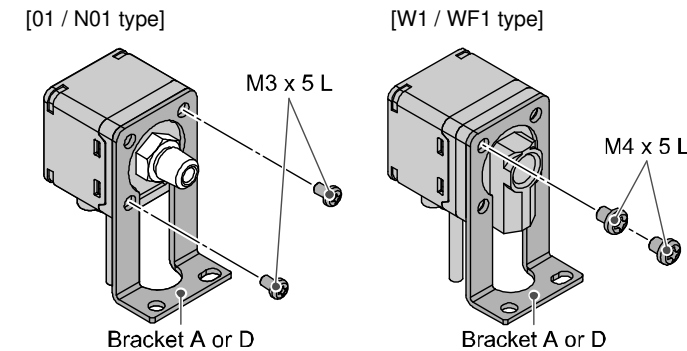

For products with M8 (3 pin) connector, be sure to reserve a space for the lead wire and connector.

**4 Installation (continued)**

**Bracket B (Part No.: ZS-24-B)**

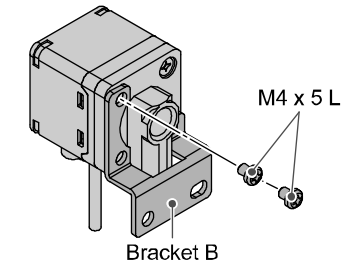

**4.1.2 Mounting with panel mount adapter**

- Products with M8 (3 pin) connector cannot be panel mounted.
- Panel mount adapter (Part No.: ZS-35-C / ZS-35-D)  
Panel mount adapter + Front protective cover (Part No.: ZS-35-F / -G).

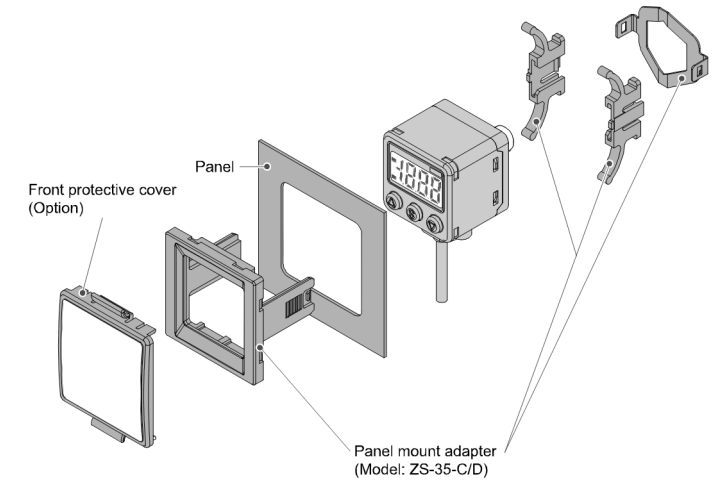

\*: The panel mount adapter can be rotated through 90 degrees for mounting.

**4.2 Environment**

**Warning**

- Do not use in an environment where corrosive gases, chemicals, salt water or steam are present.
- Do not use in an explosive atmosphere.
- Do not expose to direct sunlight. Use a suitable protective cover.
- Do not install in a location subject to vibration or impact. Check the product specifications.
- Do not mount in a location exposed to radiant heat.
- Do not use the product in a place where electrical static charge will be a problem. It can cause the error and damage to the system.

**4.3 Piping**

**Caution**

- Before piping make sure to clean up chips, cutting oil, dust etc.
- When installing piping or fittings, ensure sealant material does not enter inside the port. When using seal tape, leave 1 thread exposed on the end of the pipe/fitting.
- Tighten fittings to the specified tightening torque.

**4.3.1 Connection using screw type fitting**

- Connect suitable piping to the port.
- Hold the hexagon part of the piping port and fix. The required tightening torque is 7 to 9 N•m.
- When using an M5 female fitting confirm the fitting specification.

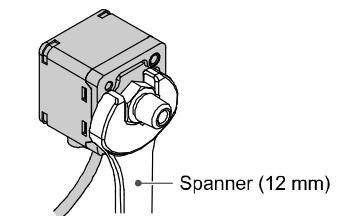

#### 4 Installation (continued)

##### 4.3.2 Connection using One-touch fitting

- Cut the tube end perpendicular.
- Hold the tube and insert it into the One-touch fitting slowly until it bottoms out.

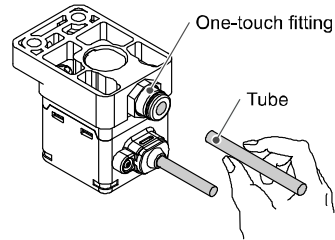

- Allow sufficient tube length to prevent twist and tensile or moment loads from being applied to the fitting or tube.
- When using a tube manufactured by a company other than SMC, check that its outside diameter tolerance satisfies the following values:
  - Nylon tube:  $\pm 0.1$  mm maximum
  - Soft nylon tube:  $\pm 0.1$  mm maximum
  - Polyurethane tube:  $+0.15$  mm /  $-2$  mm maximum

##### 4.4 Vent Tube attachment

- When the product is used in a place where water and dust splashes may occur, insert a tube into the atmospheric vent port, and route the other end of the tube to a safe place away from water and dust.

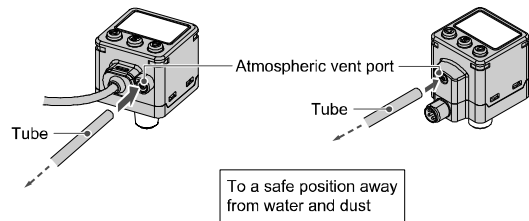

- Insert the tube into the atmospheric vent port until it bottoms out. SMC TU0425 (polyurethane, O.D  $\phi 4$ , I.D  $\phi 2.5$ ) is a suitable tubing.

##### 4.5 Lubrication

#### Caution

- SMC products have been lubricated for life at manufacture, and do not require lubrication in service.
- If a lubricant is used in the system, use turbine oil Class 1 (no additive), ISO VG32. Once lubricant is used in the system, lubrication must be continued because the original lubricant applied during manufacturing will be washed away.

#### 5 Wiring

##### 5.1 Wiring connections

- Connections should be made with the power supply turned off.
- Use a separate route for the product wiring and any power or high voltage wiring. Otherwise, malfunction may result due to noise.
- If a commercially available switching power supply is used, be sure to ground the frame ground (FG) terminal. If the switching power supply is connected for use, switching noise will be superimposed and it will not be able to meet the product specifications. In that case, insert a noise filter such as a line noise filter/ferrite between the switching power supplies or change the switching power supply to a series power supply.
- Tighten the connector by hand.

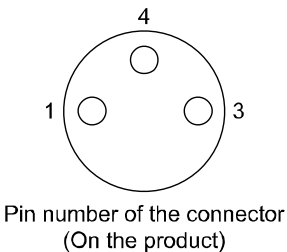

1	DC (+)
3	DC (-)
4	OUT

#### 6 Pressure Setting

##### 6.1 Measurement mode

The measurement mode is the condition where the pressure is detected and displayed, and the switch function is operating. This is the basic mode, and other modes should be selected for setting changes and other function settings.

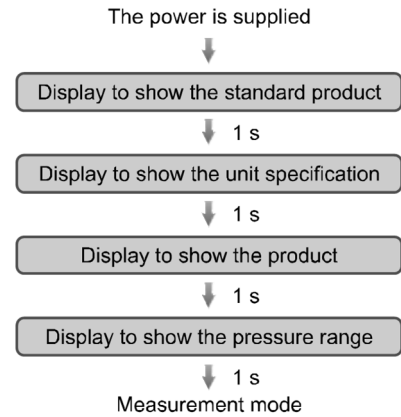

Setting the ON and OFF points of the Pressure switch.

- Operation  
When the pressure exceeds the set point, the Pressure switch will be turned ON. When the pressure falls below the set point by the amount of hysteresis or more, the Pressure switch will be turned OFF. The default setting of the output set value is the central value between the atmospheric pressure and the upper limit of the rated pressure range. If this condition, shown below, is acceptable, then keep these settings.

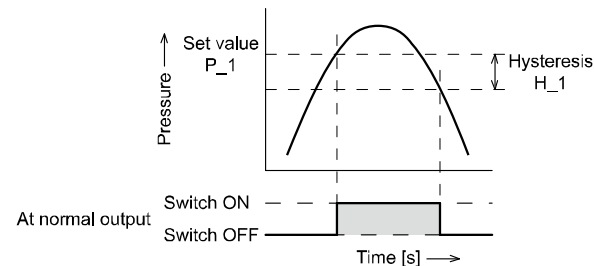

##### 6.2 Operation

[Hysteresis mode]

- Press the **S** button once in measurement mode.



- [P\_1] or [n\_1] and the set value are displayed in turn.

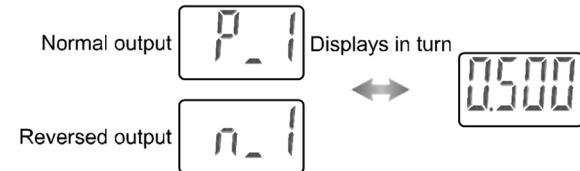

- Press the **Δ** or **▽** button to change the set value. The **Δ** button is to increase and the **▽** button is to decrease.

- Press the **Δ** button once to increase by one digit, and press it continuously to keep increasing the set value.

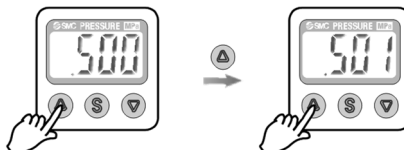

#### 6 Pressure Setting (continued)

Press the **▽** button once to decrease by one digit, and press it continuously to keep decreasing the set value.

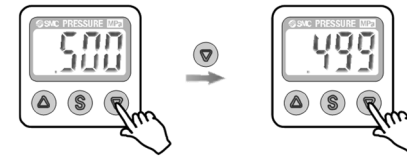

- Press the **S** button to finish the setting.

For models with 2 outputs, [P\_2] or [n\_2] will be displayed. Set as above.

The Pressure switch operates within a set pressure range (from P1L to P1H) during window comparator mode. Set P1L (switch lower limit) and P1H (switch upper limit) with the setting procedure above.

(When reversed output is selected, [n1L] and [n1H] are displayed.)

##### Zero clear of Display

The display is reset to zero when the **Δ** and **▽** buttons are pressed simultaneously for 1 second. For the first operation, always perform zero clear with no pressure applied.

#### 7 Function Setting

In measurement mode, press the **S** button for 2 seconds or longer to display [F 0]. Select to display the function to be changed, [F ##].

Press the **S** button for 2 seconds or longer in function selection mode to return to measurement mode.

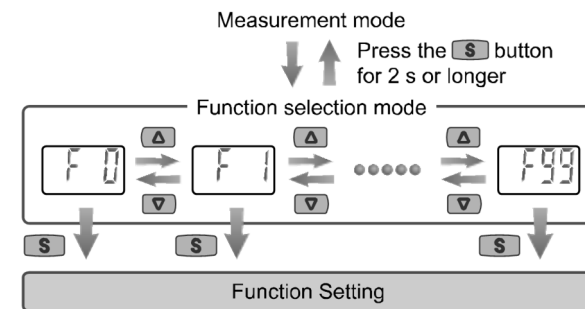

\*: Some functions are not available depending on part number. All functions are displayed with [F ##] followed by the function description. If a function is not available, the function is displayed as [---].

##### 7.1 Default Function settings

At the time of shipment, the following settings are provided. If this condition is acceptable, then keep these settings. To change the settings, enter function selection mode.

- [F 0] Unit selection function.

Unit specification	Model	Default setting
Nil or M	ISE40A	MPa
	ZSE40A(F)	kPa
P	ISE40A	psi
	ZSE40A(F)	

#### 7 Function Setting (continued)

- [F 1] Setting of OUT1

Item	Description	Default setting
Output mode	Select hysteresis mode or window comparator mode.	Hysteresis mode
Reversed output	Select reversed output.	Normal output
Pressure setting	Set the ON or OFF point of the switch output	ISE40A: 0.500 MPa ZSE40A: -50.7 kPa ZSE40AF: 50.0 kPa
Hysteresis	Set the hysteresis to prevent chattering.	ISE40A: 0.050 MPa ZSE40A: 5.1 kPa ZSE40AF: 5.0 kPa
Display colour	Select the display colour.	ON: Green OFF: Red

- [F 2] Setting of OUT2 is the same setting as [F 1] OUT1. The display colour is linked to OUT1 and cannot be set for OUT2.

- Other parameter settings

Item	Default setting
[F 3] Response time	2.5 ms
[F 4] Auto-preset function	Manual
[F 5] Setting of analogue output / auto-shift input	Analogue output
[F 6] Fine adjustment of display value	0%
[F11] Display resolution	1000-split
[F80] Power saving mode	OFF
[F81] Security code	OFF
[F90] Setting of all functions	OFF
[F97] Copy function	OFF
[F98] Check of output	Normal
[F99] Reset to the default setting	OFF

#### 8 Other Settings

##### Peak/bottom value display

The maximum (minimum) pressure when the power is supplied is detected and updated.

##### Zero clear function

The displayed value can be adjusted to zero if the measured pressure is within  $\pm 7\%$  F.S ( $\pm 3.5\%$  F.S. for compound pressure) of the zero point

##### Key-lock function

The key-lock function is used to prevent errors occurring due to unintentional changes of the set values.

For further details refer to the operation manual on the SMC website (URL: <https://www.smcworld.com>).







#### 9 How to Order

Refer to the operation manual on the SMC website (URL: <https://www.smcworld.com>) for How to order information.

#### 10 Outline Dimensions

Refer to the operation manual or catalogue on the SMC website (URL: <https://www.smcworld.com>) for Outline Dimensions.

**11 Error Indication**

Error Name	Error Display	Error Type	Troubleshooting Method
Over current Error		The switch output load current is more than 80 mA.	Turn the power off and remove the cause of the over current. Then turn the power on.
Residual Pressure Error		During zero clear operation, pressure above $\pm 7\%$ F.S. ( $\pm 3.5\%$ F.S. for compound pressure) has been applied. After 1 second, the mode will return to measurement mode. The zero clear range can vary $\pm 1\%$ F.S. with individual product differences.	Perform zero clear operation again after restoring the applied pressure to an atmospheric pressure condition.
Pressurizing Error		Pressure has exceeded the upper limit of the set pressure range.	Adjust the applied pressure to a level within the set pressure range.
		Pressure has exceeded the lower limit of the set pressure range.	
Auto-shift error		The measured pressure at auto-shift input exceeds the set pressure range. *: After 1 s, measurement mode returns automatically.	Auto-shift input is invalid. Check the connected equipment and machine.
System Error		Displayed in the case of an internal data error.	Turn the power off and turn it on again. If resetting fails, an investigation by SMC Corporation will be required.

If the error cannot be reset after the above measures are taken, contact SMC.

**12 Maintenance****12.1 General Maintenance****Caution**

- Not following proper maintenance procedures could cause the product to malfunction and lead to equipment damage.
- If handled improperly, compressed air can be dangerous.
- Maintenance of pneumatic systems should be performed only by qualified personnel.
- Before performing maintenance, turn off the power supply and be sure to cut off the supply pressure. Confirm that the air is released to atmosphere.
- After installation and maintenance, apply operating pressure and power to the equipment and perform appropriate functional and leakage tests to make sure the equipment is installed correctly.
- If any electrical connections are disturbed during maintenance, ensure they are reconnected correctly and safety checks are carried out as required to ensure continued compliance with applicable national regulations.
- Do not make any modification to the product.
- Do not disassemble the product, unless required by installation or maintenance instructions.

**How to reset the product after a power cut or forcible de-energizing**

The setting of the product will be retained as it was before a power cut or de-energizing.

The output condition is also basically recovered to that before a power cut or de-energizing but may change depending on the operating environment.

Therefore, check the safety of the whole installation before operating the product.

If the installation is using accurate control, wait until the product has warmed up (approximately 10 to 15 minutes).

**13 Limitations of Use****13.1 Limited warranty and Disclaimer/Compliance Requirements**

Refer to Handling Precautions for SMC Products.

**Caution**

- **SMC products are not intended for use as instruments for legal metrology.** Measurement instruments that SMC manufactures or sells have not been qualified by type approval tests relevant to the metrology (measurement) laws of each country. Therefore, SMC products cannot be used for business or certification ordained by the metrology (measurement) laws of each country.

**14 Product Disposal**

This product shall not be disposed of as municipal waste. Check your local regulations and guidelines to dispose of this product correctly, in order to reduce the impact on human health and the environment.

**15 Contacts**

Refer to [www.smcworld.com](http://www.smcworld.com) or [www.smc.eu](http://www.smc.eu) for your local distributor / importer.

**SMC Corporation**

URL: <https://www.smcworld.com> (Global) <https://www.smc.eu> (Europe)  
SMC Corporation, 4-14-1, Sotokanda, Chiyoda-ku, Tokyo 101-0021, Japan  
Specifications are subject to change without prior notice from the manufacturer.  
© 2021 SMC Corporation All Rights Reserved.  
Template DKP50047-F-085M