

# CXWL Series

Ball Bushing Bearing Type:  
 $\varnothing 10$ ,  $\varnothing 16$ ,  $\varnothing 25$

## Construction

$\varnothing 10$

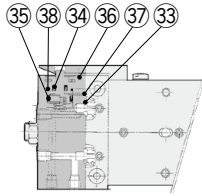

With end lock

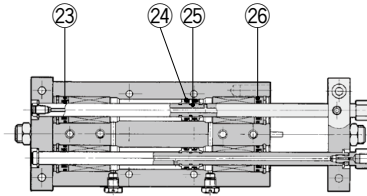

$\varnothing 16$

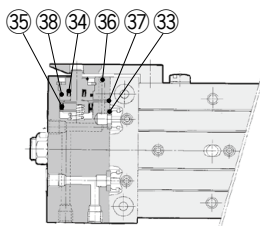

With end lock

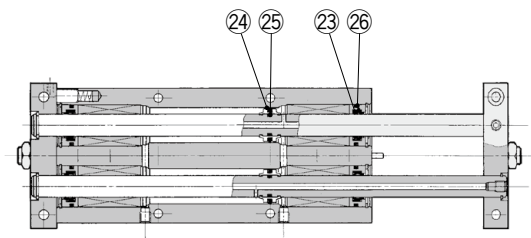

$\varnothing 25$

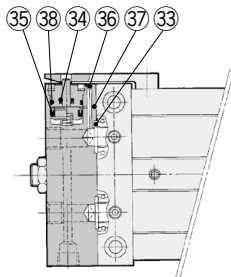

With end lock

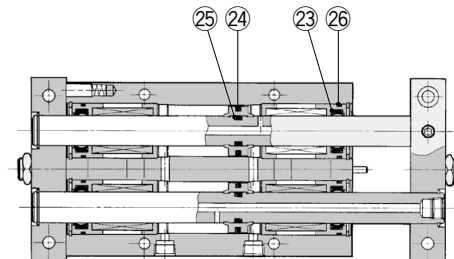

\* The numbers correspond with those in the "Construction" of the CXWL series in the **Web Catalog**.

### Seal Kit List

No.	Description	Material	Note
23	Rod seal	NBR	25 is a non-replaceable part, so it is not included in the seal kit.
24	Piston seal		
25	Piston gasket		
26	Cylinder tube gasket		

### With end lock

33	Body gasket	NBR	36 and 37 are non-replaceable parts, so they are not included in the seal kit.
34	Rod seal	NBR	
35	Piston seal	NBR	
36	Steel ball	High carbon chrome bearing steel	
37	Steel ball	High carbon chrome bearing steel	
38	O-ring	NBR	

### Replacement Parts: Seal Kit

Model	Part no.	Contents
<b>Cylinder body</b>		
CXWL10	CXWL10-PS	Set of nos. 23, 24, 26
CXWL16	CXWL16-PS	
CXWL25	CXWL25-PS	

\* The seal kit includes 23, 24 and 26. Order the seal kit with the part number for each model.

\* 25 is not replaceable.

\* Since the seal kit does not include a grease pack, it should be ordered separately.

**Grease pack part no.:** GR-S-010 (10 g)

### End lock

CXWL10	CXWL10R-PS	Set of nos. 33, 34, 35, 38
CXWL16	CXWL16R-PS	
CXWL25	CXWL25R-PS	

\* The seal kit includes 33, 34, 35 and 38. Order the seal kit with the part number for each model.

\* Since the seal kit does not include a grease pack, it should be ordered separately.

**Grease pack part no.:** GR-S-010 (10 g)

# CXWL Series

Ball Bushing Bearing Type:  
 $\varnothing 20, \varnothing 32$

## Construction

$\varnothing 20$

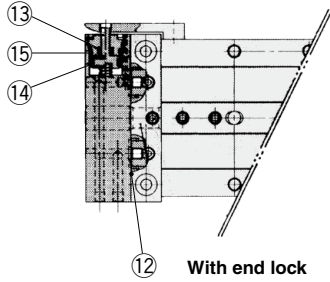

With end lock

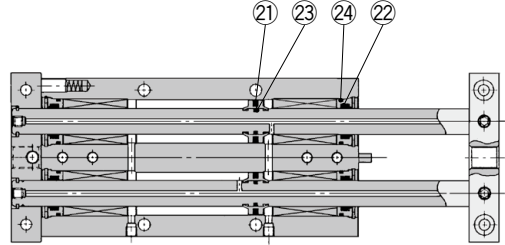

$\varnothing 32$

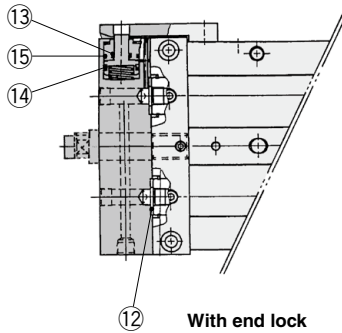

With end lock

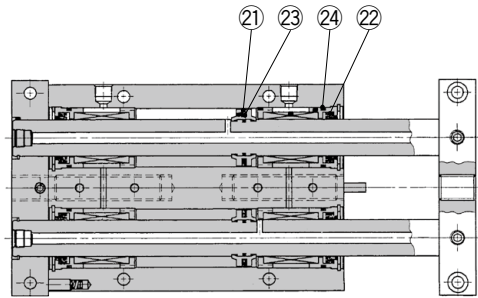

\* The numbers correspond with those in the "Construction" of the CXWL series in the **Web Catalog**.

### Seal Kit List

No.	Description	Material	Note
21	Piston seal	NBR	<b>23 is a non-replaceable part, so it is not included in the seal kit.</b>
22	Rod seal		
23	Piston gasket		
24	Cylinder tube gasket		

### With end lock

12	Body gasket	NBR
13	Rod seal	
14	Piston seal	
15	O-ring	

### Replacement Parts: Seal Kit

Model	Part no.	Contents
CXWL20	CXWL20-PS	Set of nos. 21, 22, 24
CXWL32	CXWL32-PS	21, 22, 24

\* The seal kit includes 21, 22 and 24. Order the seal kit with the part number for each model.

\* 23 is not replaceable.

\* Since the seal kit does not include a grease pack, it should be ordered separately.

**Grease pack part no.: GR-S-010 (10 g)**

### End lock

CXWL20	CXWL20R-PS	Set of nos. 12, 13, 14, 15
CXWL32	CXWL32R-PS	12, 13, 14, 15

\* The seal kit includes 12, 13, 14 and 15. Order the seal kit with the part number for each model.

\* Since the seal kit does not include a grease pack, it should be ordered separately.

**Grease pack part no.: GR-S-010 (10 g)**

Actuators

Rotary Actuators  
Air Grippers

Modular F.R.L.  
Pressure Control Equipment

Air Preparation  
Equipment

Industrial Filters

Replacement  
Procedure

Actuators

Rotary Actuators  
Air Grippers

Modular F.R.L.  
Pressure Control Equipment

Air Preparation Equipment  
Industrial Filters